

1742087-2 ✓ ACTIVE

FASTON | FASTON 187

TE Internal #: 1742087-2

Quick Disconnects, Receptacle, 22 – 18 AWG Wire Size, .32 – .82 mm² Wire Size, Mating Tab Width 4.75 mm [.187 in], Flag, Brass, FASTON 187

[View on TE.com >](#)



Terminals & Splices > Quick Disconnects

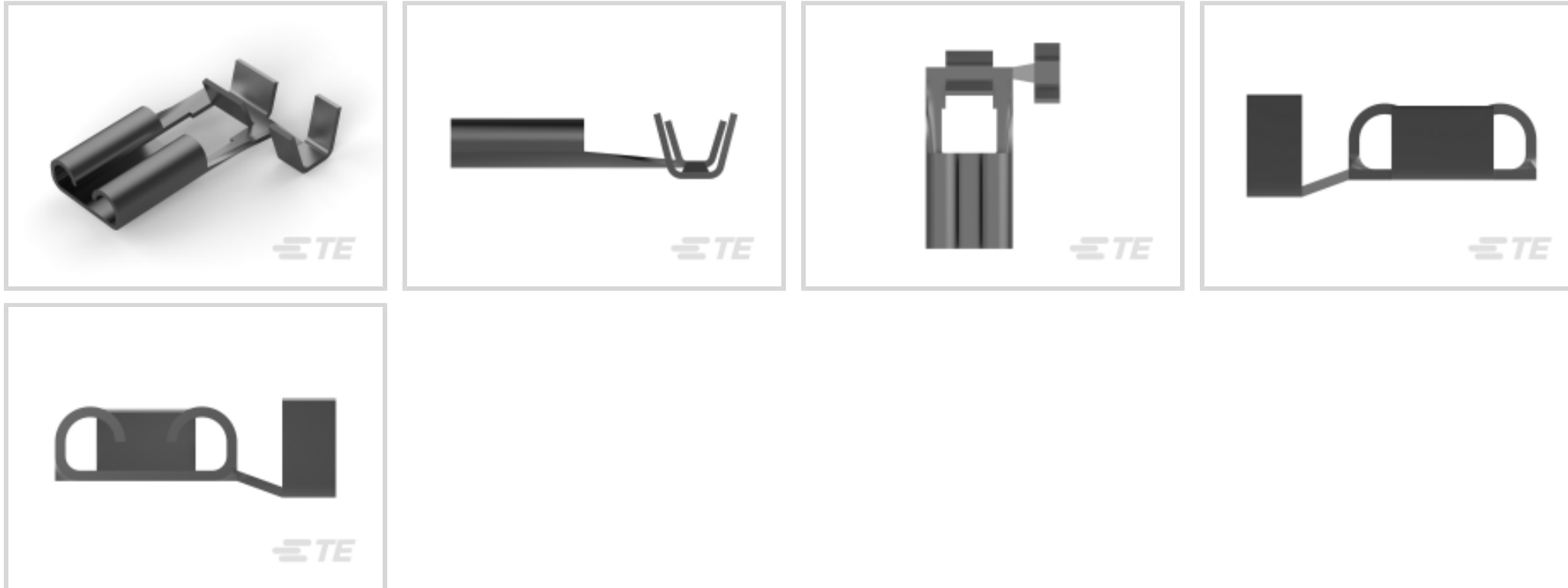

Quick Disconnect Terminal Type: **Receptacle**

Wire Size: .32 – .82 mm²

Mating Tab Width: 4.75 mm [.187 in]

Mating Tab Thickness: .81 mm [.032 in]

Features

Product Type Features

Insertion Force	Low
-----------------	-----

Configuration Features

Connection Capacity	Single
Compatible With Wire & Cable Type	Discrete Wire

Contact Features

Quick Disconnect Terminal Type	Receptacle
Mating Tab Width	4.75 mm [.187 in]
Mating Tab Thickness	.81 mm [.032 in]
Terminal Orientation	Flag
Contact Base Material	Brass
Terminal Plating Material	Tin
Crimp Type	F-Crimp
Barrel Type	Open

Termination Features

--	--



Product Terminates To	Wire & Cable
-----------------------	--------------

Mechanical Attachment

Wire Insulation Support	With
Mating Retention Type	Dimple

Dimensions

Terminal Material Thickness	.33 mm[.013 in]
Product Length	11.3 mm[.444 in]
Compatible Insulation Diameter Range	1.52 – 2.8 mm[.06 – .11 in]
Wire Size	.32 – .82 mm ²

Usage Conditions

Insulation Option	Uninsulated
Operating Temperature Range	-40 – 110 °C[-40 – 230 °F]

Industry Standards

Agency/Standard	UL
-----------------	----

Packaging Features

Packaging Quantity	15000
Packaging Method	Strip/Reel

Other

Line	Budget
------	--------

Product Compliance

[For compliance documentation, visit the product page on TE.com>](#)

EU RoHS Directive 2011/65/EU	Compliant
EU ELV Directive 2000/53/EC	Compliant
China RoHS 2 Directive MIIT Order No 32, 2016	No Restricted Materials Above Threshold
EU REACH Regulation (EC) No. 1907/2006	Current ECHA Candidate List: JUNE 2023 (235) Candidate List Declared Against: JUNE 2023 (235) Does not contain REACH SVHC
Halogen Content	Low Halogen - Br, Cl, F, I < 900 ppm per homogenous material. Also BFR/CFR/PVC Free
Solder Process Capability	Not applicable for solder process capability

Product Compliance Disclaimer

This information is provided based on reasonable inquiry of our suppliers and represents our current actual knowledge based on the information they provided. This information is subject to change. The part numbers that TE has identified as EU RoHS compliant have a maximum concentration of 0.1% by weight in homogenous materials for lead, hexavalent chromium, mercury, PBB, PBDE, DBP, BBP, DEHP, DIBP, and 0.01% for cadmium, or qualify for an exemption to these limits as defined in the Annexes of Directive 2011/65/EU (RoHS2). Finished electrical and electronic equipment products will be CE marked as required by Directive 2011/65/EU. Components may not be CE marked. Additionally, the part numbers that TE has identified as EU ELV compliant have a maximum concentration of 0.1% by weight in homogenous materials for lead, hexavalent chromium, and mercury, and 0.01% for cadmium, or qualify for an exemption to these limits as defined in the Annexes of Directive 2000/53/EC (ELV). Regarding the REACH Regulation, the information TE provides on SVHC in articles for this part number is based on the latest European Chemicals Agency (ECHA) 'Guidance on requirements for substances in articles' posted at this URL: <https://echa.europa.eu/guidance-documents/guidance-on-reach>

Compatible Parts



TE Part # 2-2150397-1
OCEAN_2.0_Applicator-E-070F1400



TE Part # 2-2150397-2
OCEAN_2.0_Applicator-E-070F1400-A



TE Part # 2-2150447-2
OCEAN_2.0_Applicator-E-070F1100V



TE Part # 2150397-1
OCEAN_2.0_Applicator-E-070F1400



TE Part # 2150397-2
OCEAN_2.0_Applicator-E-070F1400-A



TE Part # 2150447-1
OCEAN_2.0_Applicator-E-070F1100V



TE Part # 2150447-2
OCEAN_2.0_Applicator-E-070F1100V



TE Part # 626481-2
FASTON 110 FLAG REC 0.5-1.5 MM² TPBR



TE Part # 7-2150397-1
OCEAN_2.0_Applicator-E-070F1400



TE Part # 7-2150397-2
OCEAN_2.0_Applicator-E-070F1400-A



TE Part # 7-2150397-7
OCEAN_2.0_SPARE_PART_KIT-180F250F



TE Part # 7-2150447-1
OCEAN_2.0_Applicator-E-070F1100V



Also in the Series | **FASTON 187**

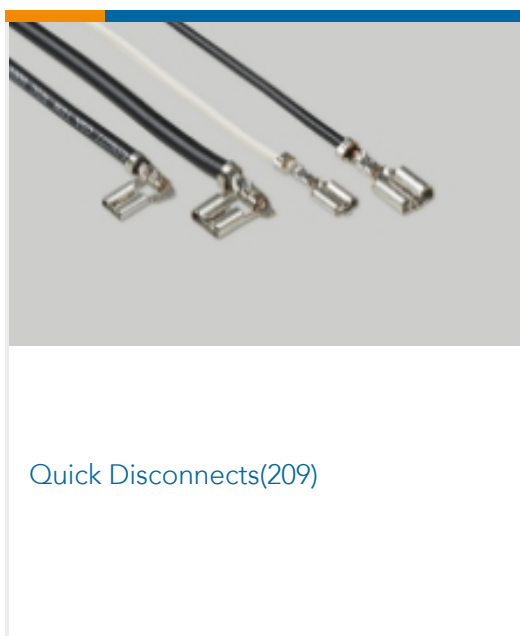
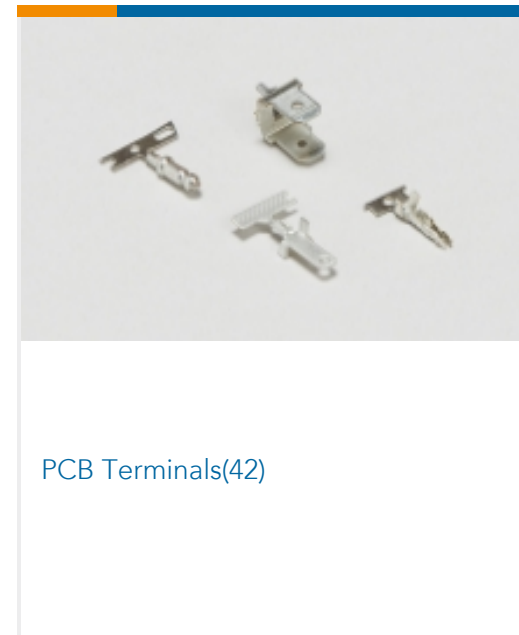
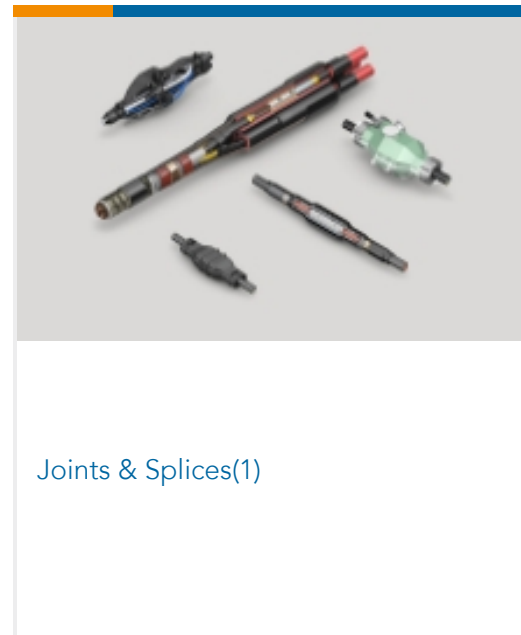
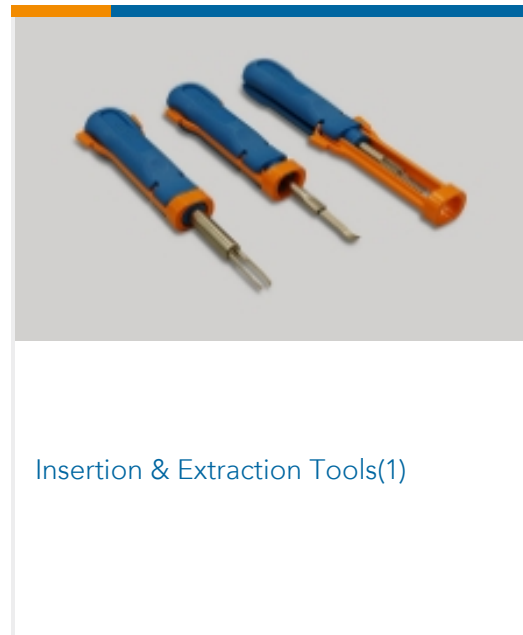
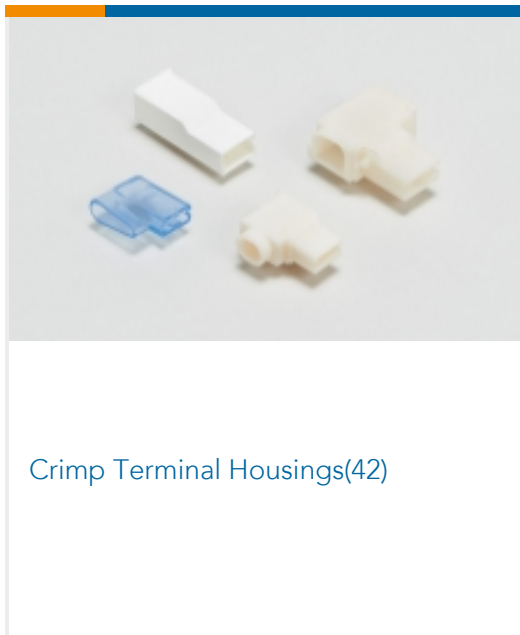

Customers Also Bought

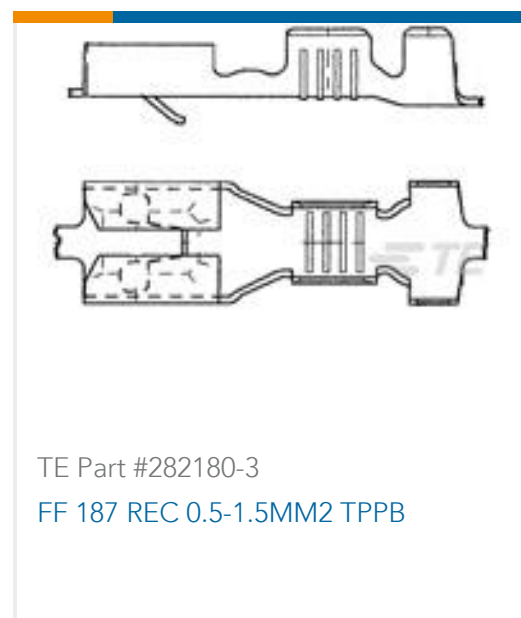



Documents

Product Drawings

[187 FASTON, FLAG, REC., 18-22 AWG, TPBR](#)

English

CAD Files

Customer View Model

[ENG_CVM_CVM_1742087-2_F.2d_dxf.zip](#)

English

3D PDF

3D

Customer View Model

[ENG_CVM_CVM_1742087-2_F.3d_igs.zip](#)

English

Customer View Model

[ENG_CVM_CVM_1742087-2_F.3d_stp.zip](#)

English

By downloading the CAD file I accept and agree to the [Terms and Conditions](#) of use.

Datasheets & Catalog Pages

[82004 FASTON Terminals \(Insulated and Uninsulated\) Catalog - FASTON Receptacles Section](#)

English

Product Specifications

[Application Specification](#)

English

Product Environmental Compliance

[MD_1742087-2_09282018958_dmtec](#)

English

[MD_1742087-2_09282018958_dmtec](#)

English

Agency Approvals

[CSA Certificate](#)

English

[CSA Certificate](#)



English