

173853-1 ✓ ACTIVE

AMP | Multilock Connector System

TE Internal #: 173853-1

Housing for Female Terminals, Wire-to-Wire, 18 Position, .232 in [5.9 mm] Centerline, Signal, Cable Mount (Free-Hanging), Multilock Connector System

[View on TE.com >](#)



Connectors > Automotive Connectors > Automotive Housings > MULTILOCK, CONNECTOR HOUSING

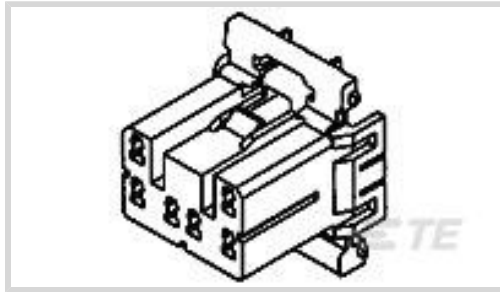

Connector System: **Wire-to-Wire**

Number of Positions: **18**

Connector & Housing Type: **Housing for Female Terminals**

Centerline (Pitch): **5.9 mm [.232 in]**

Sealable: **No**

[All MULTILOCK, CONNECTOR HOUSING \(567\)](#)

Features

Product Type Features

Mixed & Hybrid Connector	No
Connector Shape	Rectangular
Connector System	Wire-to-Wire
Connector & Housing Type	Housing for Female Terminals
Sealable	No
Primary Locking Feature	Integrated in Housing

Configuration Features

Number of Positions	18
Number of Rows	2

Electrical Characteristics

Operating Voltage	12 VDC
Nominal Voltage Architecture	12 V

Body Features

Cable Exit Angle	180°
------------------	------

Contact Features

Contact Size	1.8mm
--------------	-------



Contact Type	Receptacle
--------------	------------

Mating Tab Width	1.8 mm[.071 in]
------------------	-----------------

Mechanical Attachment

Terminal Position Assurance	Yes
-----------------------------	-----

Strain Relief	Without
---------------	---------

Mating Alignment Type	Polarized
-----------------------	-----------

Mating Alignment	With
------------------	------

Connector Mounting Type	Cable Mount (Free-Hanging)
-------------------------	----------------------------

Housing Features

Housing Material	PBT
------------------	-----

Centerline (Pitch)	5.9 mm[.232 in]
--------------------	-----------------

Dimensions

Connector Height	26.05 mm[1.026 in]
------------------	--------------------

Product Width	42.3 mm[1.665 in]
---------------	-------------------

Product Length	21.6 mm[.85 in]
----------------	-----------------

Row-to-Row Spacing	3 mm, 5 mm, 7.5 mm, 8 mm[.118 in][.197 in][.295 in][.315 in]
--------------------	--

Usage Conditions

Operating Temperature (Max)	70 °C, 75 °C, 80 °C, 85 °C, 90 °C, 100 °C, 105 °C[158 °F][167 °F][176 °F][185 °F][194 °F][212 °F][221 °F]
-----------------------------	---

Operating Temperature Range	-30 – 105 °C[-22 – 221 °F]
-----------------------------	----------------------------

Operation/Application

Circuit Application	Signal
---------------------	--------

Industry Standards

UL Flammability Rating	UL 94HB
------------------------	---------

Packaging Features

Packaging Quantity	50
--------------------	----

Other

Serviceable	Yes
-------------	-----

Connector Position Assurance Capable	No
--------------------------------------	----

Product Compliance

[For compliance documentation, visit the product page on TE.com>](#)

EU RoHS Directive 2011/65/EU	Compliant
EU ELV Directive 2000/53/EC	Compliant
China RoHS 2 Directive MIIT Order No 32, 2016	No Restricted Materials Above Threshold
EU REACH Regulation (EC) No. 1907/2006	Current ECHA Candidate List: JUNE 2023 (235) Candidate List Declared Against: JUNE 2023 (235) Does not contain REACH SVHC
Halogen Content	Low Halogen - Br, Cl, F, I < 900 ppm per homogenous material. Also BFR/CFR/PVC Free
Solder Process Capability	Not applicable for solder process capability

Product Compliance Disclaimer

This information is provided based on reasonable inquiry of our suppliers and represents our current actual knowledge based on the information they provided. This information is subject to change. The part numbers that TE has identified as EU RoHS compliant have a maximum concentration of 0.1% by weight in homogenous materials for lead, hexavalent chromium, mercury, PBB, PBDE, DBP, BBP, DEHP, DIBP, and 0.01% for cadmium, or qualify for an exemption to these limits as defined in the Annexes of Directive 2011/65/EU (RoHS2). Finished electrical and electronic equipment products will be CE marked as required by Directive 2011/65/EU. Components may not be CE marked. Additionally, the part numbers that TE has identified as EU ELV compliant have a maximum concentration of 0.1% by weight in homogenous materials for lead, hexavalent chromium, and mercury, and 0.01% for cadmium, or qualify for an exemption to these limits as defined in the Annexes of Directive 2000/53/EC (ELV). Regarding the REACH Regulation, the information TE provides on SVHC in articles for this part number is based on the latest European Chemicals Agency (ECHA) 'Guidance on requirements for substances in articles' posted at this URL: <https://echa.europa.eu/guidance-documents/guidance-on-reach>

Compatible Parts

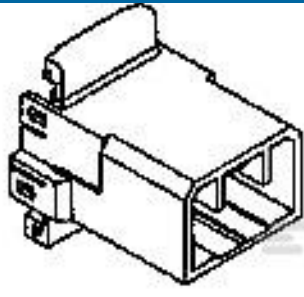
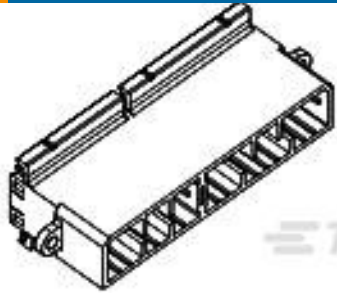
 <p>TE Part # CAT-M9194-T273 MULTILOCK, RECEPTACLE AND TAB</p>	 <p>TE Part # CAT-LMPH9507 Low & Medium Power Header</p>	 <p>TE Part # CAT-SIGH262 Signal Header</p>	 <p>TE Part # 368509-1 070 MLC CAP 18P HSG</p>
 <p>TE Part # 174935-1 070 MLC W-W CAP HSG 18P</p>	 <p>TE Part # 345208-1 070 SERIES RECEPT.</p>	 <p>TE Part # 1-174939-1 070 MLC CAP HSG 30P W/FLANGE</p>	 <p>TE Part # 173862-3 070 MLC 18POS CAP ASSY H TIN</p>



TE Part # 174480-1
070 MULTI CAP ASSY 42P H



TE Part # 175026-1
070 REC CONTACT L.P 24-22

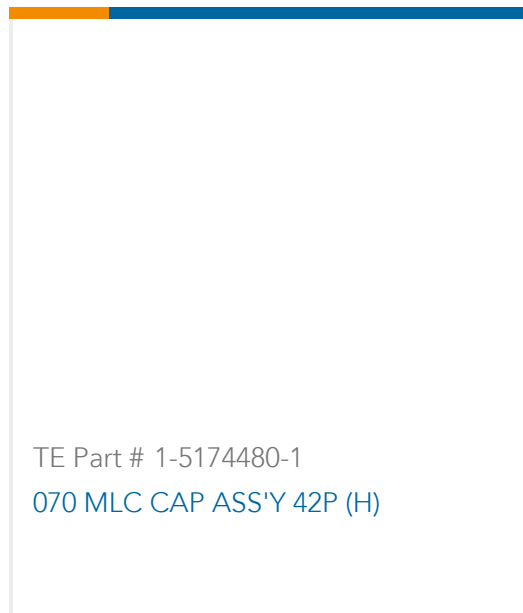

TE Part # 1-5174480-1
070 MLC CAP ASS'Y 42P (H)

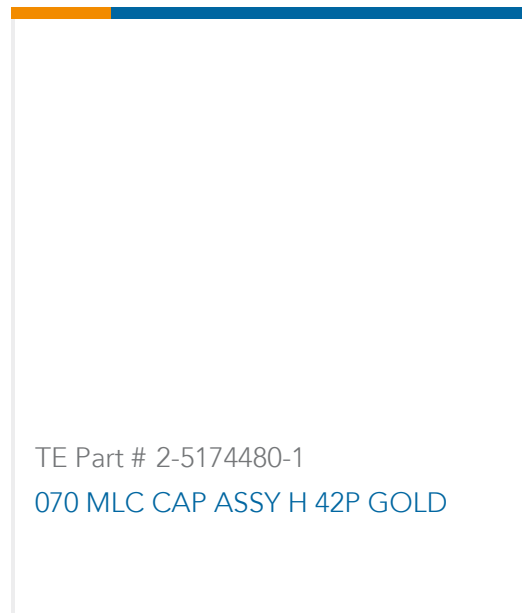

TE Part # 2-5174480-1
070 MLC CAP ASSY H 42P GOLD



TE Part # 1-174480-1
070 MLC CAP ASS'Y 42P (H)

Also in the Series | **Multilock Connector System**



Automotive Connector Caps & Covers (17)



Automotive Connector EMC Shielding (1)

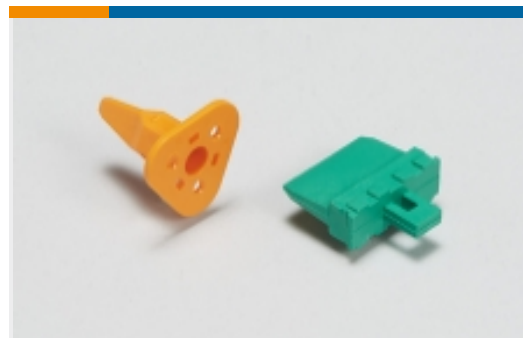

Automotive Connector Locks & Position Assurance(2)



Automotive Housings(603)



Automotive Terminals(141)



Connector Seals & Cavity Plugs(2)



Insertion & Extraction Tools(6)



Other Automotive Connector Accessories(14)

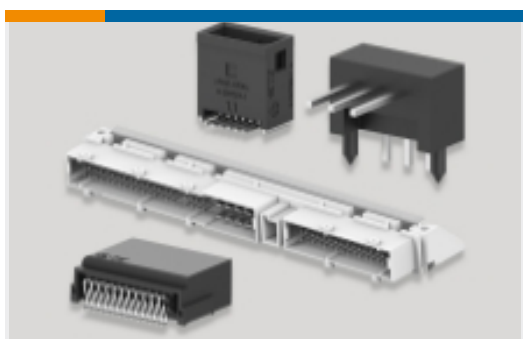

PCB Headers & Receptacles(142)

Customers Also Bought



TE Part #178482-1
UP 3.96 5P PLUG HSG NATRL



TE Part #170454-1
PL 250 AUTOMOTIVE REC 18-14 0.40 X 21 BR



TE Part #175027-1
MULTILOCK, RECEPTACLE AND TAB



TE Part #1318389-2
025 40P PLUG ASSY

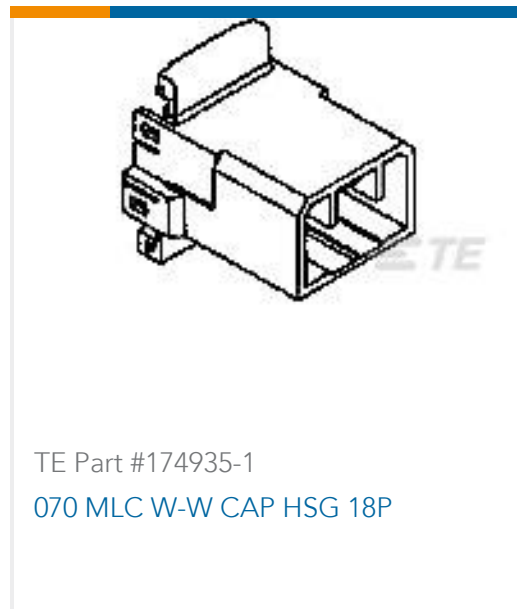

TE Part #174935-1
070 MLC W-W CAP HSG 18P



TE Part #2174106-1
PLUG HOUSING ASSEMBLY 50POS 0.5 /1.0

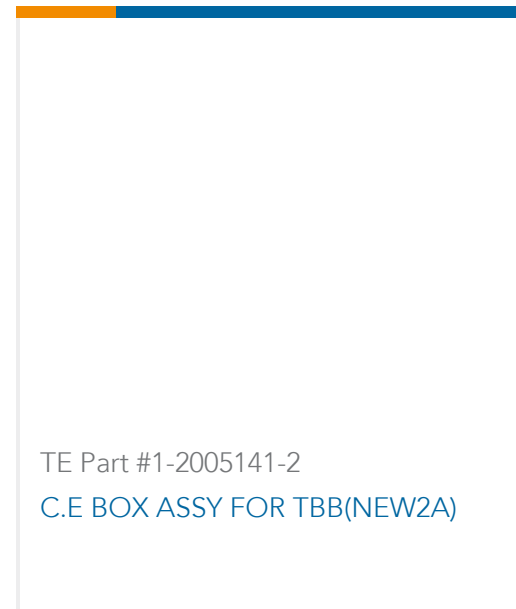

TE Part #1-2005141-2
C.E BOX ASSY FOR TBB(NEW2A)

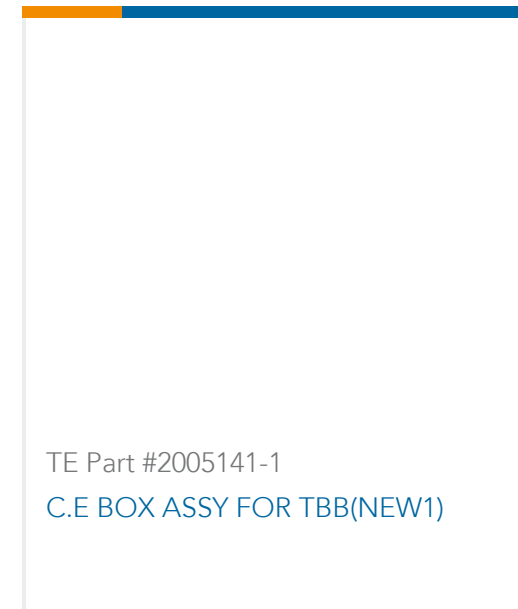

TE Part #2005141-1
C.E BOX ASSY FOR TBB(NEW1)

Documents

Product Drawings

070 MULTILOCK PLUG 18P

English

CAD Files

3D PDF

English

Customer View Model

[ENG_CVM_173853-1_E1.2d_dxf.zip](#)

English

Customer View Model

[ENG_CVM_173853-1_E1.3d_igs.zip](#)

English

Customer View Model

[ENG_CVM_173853-1_E1.3d_stp.zip](#)

English

By downloading the CAD file I accept and agree to the [Terms and Conditions](#) of use.

Datasheets & Catalog Pages

MULTILOCK Connector System

English

Product Specifications

070 MLC Series

English

Product Specification

Japanese



Product Specification

Japanese

Agency Approvals

CSA Certificate

English