

173716-1 ✓ ACTIVE

AMP | Multilock Connector System

TE Internal #: 173716-1

Automotive Terminals, Receptacle, Mating Tab Width 1 mm [.039 in], Tab Thickness .64 mm [.025 in], 22 – 20 AWG Wire Size, Multilock Connector System

[View on TE.com >](#)



Terminals & Splices > Automotive Terminals > MULTILOCK, RECEPTACLE AND TAB



Terminal Type: **Receptacle**

Mating Tab Width: **1 mm [.039 in]**

Mating Tab Thickness: **.64 mm [.025 in]**

Terminal Transmits: **0 – 24 A (Low Power)**

Wire Size: **22 – 20 AWG**

[All MULTILOCK, RECEPTACLE AND TAB \(136\)](#)

Features

Product Type Features

Receptacle Style	180°
Sealable	No
Primary Locking Feature	Clean Body

Contact Features

Contact Size	1mm
Contact Fabrication	Stamped & Formed
Wire Contact Termination Area Plating Material	Tin
Typical Current Rating	5 A
Crimp Type	F-Crimp
Terminal Type	Receptacle
Mating Tab Width	1 mm [.039 in]
Mating Tab Thickness	.64 mm [.025 in]
Interface Plating	Tin (Sn)

Termination Features

Termination Method to Wire & Cable	Crimp
Product Terminates To	Wire

Dimensions

Compatible Insulation Diameter Range	1.8 – 2 mm [.07 – .079 in]
Wire Size	.3 – .5 mm ²
Wire Size Search	20 AWG, 21 AWG, 22 AWG

Usage Conditions

Insulation Option	Uninsulated
Operating Temperature (Max)	80 °C, 85 °C, 90 °C, 100 °C, 105 °C [176 °F][185 °F][194 °F][212 °F][221 °F]
Operating Temperature Range	-30 – 105 °C [-22 – 221 °F]

Packaging Features

Packaging Quantity	5000
Packaging Method	Reel

Other

Terminal Transmits	0 – 24 A (Low Power)
--------------------	----------------------

Product Compliance

For compliance documentation, visit the product page on [TE.com](https://www.te.com)>

EU RoHS Directive 2011/65/EU	Compliant
EU ELV Directive 2000/53/EC	Compliant
China RoHS 2 Directive MIIT Order No 32, 2016	No Restricted Materials Above Threshold
EU REACH Regulation (EC) No. 1907/2006	Current ECHA Candidate List: JUNE 2023 (235) Candidate List Declared Against: JUNE 2023 (235) Does not contain REACH SVHC
Halogen Content	Low Halogen - Br, Cl, F, I < 900 ppm per homogenous material. Also BFR/CFR/PVC Free
Solder Process Capability	Not applicable for solder process capability

Product Compliance Disclaimer

This information is provided based on reasonable inquiry of our suppliers and represents our current actual knowledge based on the information they provided. This information is subject to change. The part numbers that TE has identified as EU RoHS compliant have a maximum concentration of 0.1% by weight in homogenous materials for lead, hexavalent chromium, mercury, PBB, PBDE, DBP, BBP, DEHP, DIBP, and 0.01% for cadmium, or qualify for an exemption to these limits as defined in the Annexes of Directive 2011/65/EU (RoHS2). Finished electrical and electronic equipment products will be CE marked as required by Directive 2011/65/EU. Components may not be CE marked. Additionally, the part numbers that TE has identified as EU ELV compliant have a maximum concentration of 0.1% by weight in homogenous materials for lead, hexavalent chromium, and mercury, and 0.01% for cadmium, or qualify for an exemption to these limits as defined in the Annexes of Directive 2000/53/EC (ELV). Regarding the REACH Regulation, the information TE provides

on SVHC in articles for this part number is based on the latest European Chemicals Agency (ECHA) 'Guidance on requirements for substances in articles' posted at this URL: <https://echa.europa.eu/guidance-documents/guidance-on-reach>

Compatible Parts



TE Part # 2305570-1
Strip Terminal Cutter-Side Feed-No Crimp



TE Part # CAT-M9194-CH8172
MULTILOCK, CONNECTOR HOUSING



TE Part # 755430-1
EXT TOOL FOR DOUBLE LOOK



TE Part # 58522-2
PRO-CRMPR II DIE



TE Part # 91577-1
CCII 040 SERIES REC TAB 22-20 ASSY



TE Part # 2151184-1
OCEAN_2.0_APPLICATOR-S-062F070BX



TE Part # 2151184-2
OCEAN_2.0_APPLICATOR-S-062F070BX



TE Part # 5-2151184-1
OCEAN_2.0_APPLICATOR-S-062F070BX



TE Part # 5-2151184-2
OCEAN_2.0_APPLICATOR-S-062F070BX



TE Part # 7-2151184-1
OCEAN_2.0_APPLICATOR-S-062F070BX



TE Part # 7-2151184-2
OCEAN_2.0_APPLICATOR-S-062F070BX



TE Part # 7-2151184-7
OCEAN_2.0_SPARE_PART_KIT-062F070BX



TE Part # 7-2266366-7
OC-062F070BX-752-CRIMP TOOLING KIT



TE Part # 2-2151184-1
OCEAN_2.0_APPLICATOR-S-062F070BX



TE Part # 2-2151184-2
OCEAN_2.0_APPLICATOR-S-062F070BX

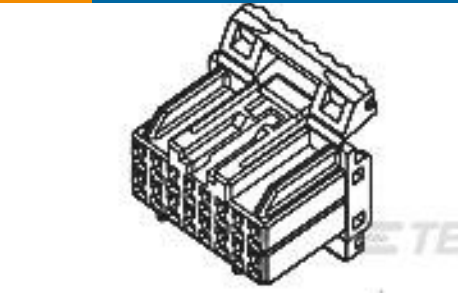

TE Part # 175567-6
HYBRID I/O PLUG HSG 26P GRAY



Also in the Series | Multilock Connector System

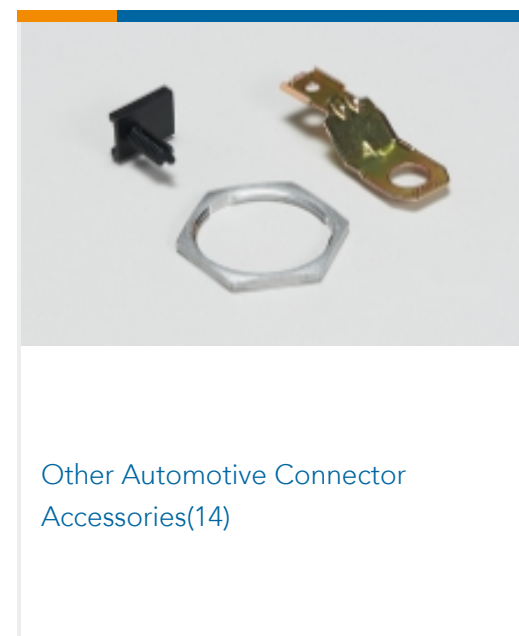
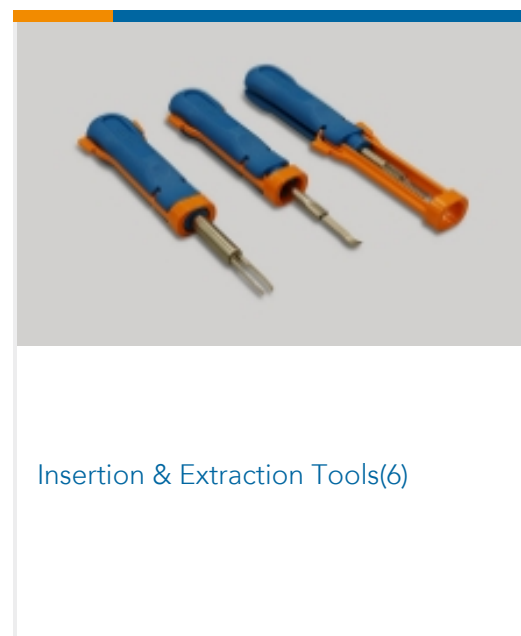
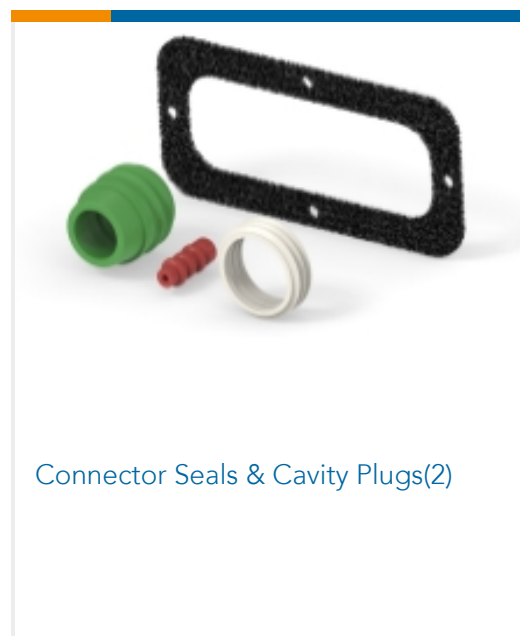
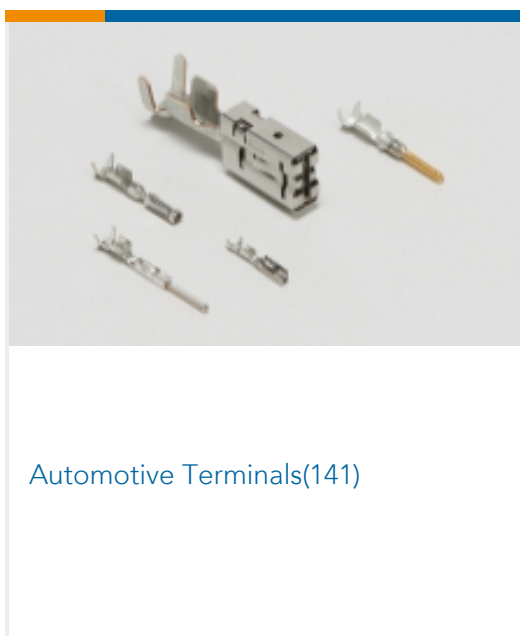
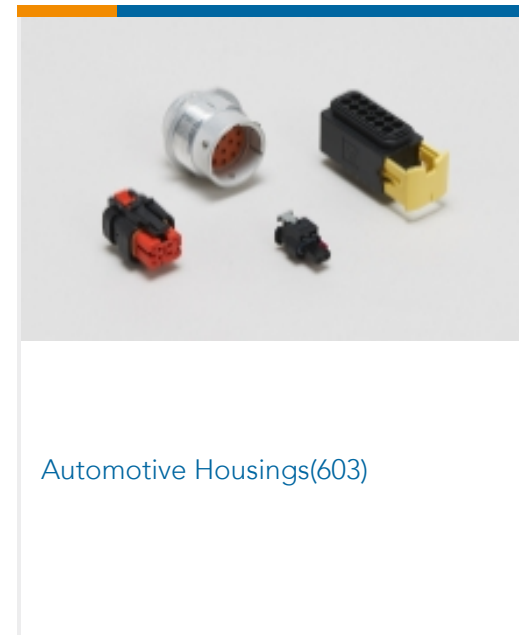
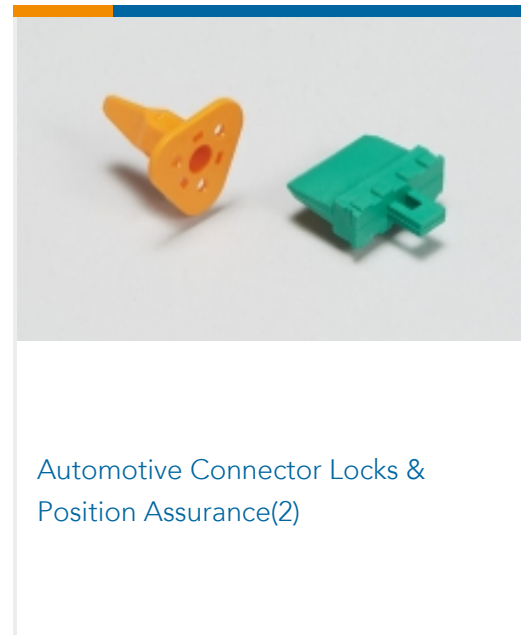
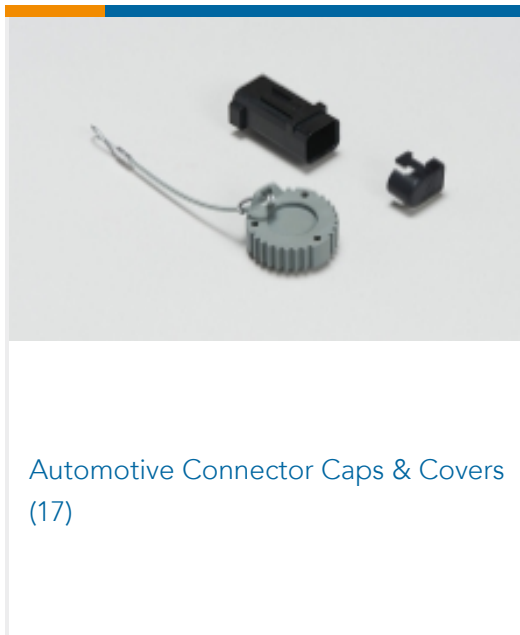

Customers Also Bought



TE Part #1-2109363-2 DIODE ASSY 4A L/P	TE Part #2819293-1 PIVOTED ARM ASSEMBLY	TE Part #2391351-1 TPA REC HSG,57POS,HYBRID	TE Part #2819292-1 ARM GUIDE
-------------------------------------------	--------------------------------------------	------------------------------------------------	---------------------------------

Documents

Product Drawings

040 HDIO REC CONT

English

CAD Files

Customer View Model

ENG_CVM_173716-1_O1.3d_igs.zip

English

Customer View Model

ENG_CVM_173716-1_O1.3d_stp.zip

English

Customer View Model

ENG_CVM_173716-1_O1.2d_dxf.zip

English

3D PDF

English

By downloading the CAD file I accept and agree to the [Terms and Conditions](#) of use.

Datasheets & Catalog Pages

MULTILOCK Connector System

English

Product Specifications

Application Specification

English

Crimping .040 Series Receptacle Contact

English

Instruction Sheets

Customer Manual (non U.S.)

Japanese

.040 Series Multilock I/O Connector Mark II

Japanese

HYBRID I/O CONNECTOR

English

Customer Manual (non U.S.)



English

HYBRID I/O CONNECTOR

English

Customer Manual (non U.S.)

English

Customer Manual (non U.S.)

Japanese

.040 Series, Multilock I/O Connector, Mark II

Japanese