

172864-2 ✓ ACTIVE

[Positive Lock](#) | [Positive Lock 250](#)

TE Internal #: 172864-2

Crimp Terminal Housings, Receptacle, Receptacle, 2 Position,
Straight, UL 94V-0, Black, Nylon, Contact Mating Retention, Positive
Lock 250

[View on TE.com >](#)



Terminals & Splices > Terminal Housings, Insulation Sleeves & Blocks > Crimp Terminal Housings



Terminal Type: **Receptacle**

Connector & Housing Type: **Receptacle**

Number of Positions: **2**

Terminal Orientation: **Straight**

UL Flammability Rating: **UL 94V-0**

Features

Product Type Features

Sealable	No
Connector System	Wire-to-Board, Wire-to-Wire
Connector & Contact Terminates To	Wire & Cable
Connector & Housing Type	Receptacle

Configuration Features

Number of Positions	2
---------------------	---

Body Features

Primary Product Color	Black
-----------------------	-------

Contact Features

Terminal Type	Receptacle
Terminal Orientation	Straight
Contact Mating Retention	With

Mechanical Attachment



Mating Alignment Type	Polarization
Mating Retention Type	Latch
Mating Alignment	With
Connector Mounting Type	Cable Mount (Free-Hanging)

Housing Features

Housing Material	Nylon
Centerline (Pitch)	6 mm [.236 in]

Usage Conditions

Operating Temperature Range	-40 – 105 °C [-40 – 221 °F]
-----------------------------	-----------------------------

Industry Standards

UL Flammability Rating	UL 94V-0
------------------------	----------

Packaging Features

Packaging Quantity	100
--------------------	-----

Product Compliance

[For compliance documentation, visit the product page on TE.com>](#)







EU RoHS Directive 2011/65/EU	Compliant
EU ELV Directive 2000/53/EC	Compliant
China RoHS 2 Directive MIIT Order No 32, 2016	No Restricted Materials Above Threshold
EU REACH Regulation (EC) No. 1907/2006	Current ECHA Candidate List: JUNE 2023 (235) Candidate List Declared Against: JUNE 2023 (235) Does not contain REACH SVHC
Halogen Content	Low Halogen - Br, Cl, F, I < 900 ppm per homogenous material. Also BFR/CFR/PVC Free
Solder Process Capability	Not applicable for solder process capability

Product Compliance Disclaimer

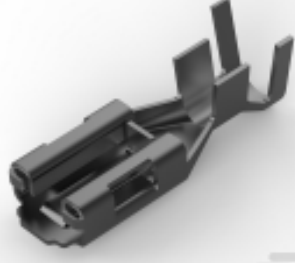
This information is provided based on reasonable inquiry of our suppliers and represents our current actual knowledge based on the information they provided. This information is subject to change. The part numbers that TE has identified as EU RoHS compliant have a maximum concentration of 0.1% by weight in homogenous materials for lead, hexavalent chromium, mercury, PBB, PBDE, DBP, BBP, DEHP, DIBP, and 0.01% for cadmium, or qualify for an exemption to these limits as defined in the Annexes of Directive 2011/65/EU (RoHS2). Finished electrical and electronic equipment products will be CE marked as required by Directive 2011/65/EU. Components may not be CE marked. Additionally, the part numbers that TE has identified as EU ELV compliant have a maximum concentration of 0.1% by weight in homogenous materials for lead, hexavalent chromium, and mercury, and 0.01% for cadmium, or qualify for an exemption to these limits as defined in the Annexes of Directive 2000/53/EC (ELV). Regarding the REACH Regulation, the information TE provides on SVHC in articles for this part number is based on the latest European Chemicals Agency (ECHA) 'Guidance on

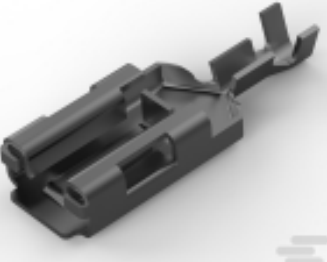
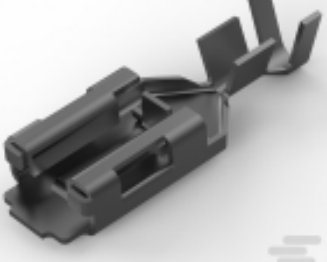
requirements for substances in articles' posted at this URL: <https://echa.europa.eu/guidance-documents/guidance-on-reach>

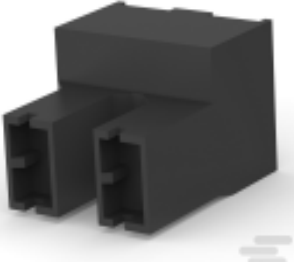
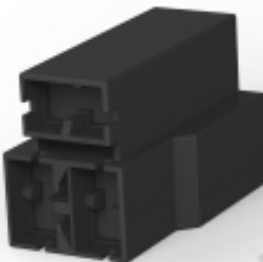
Compatible Parts

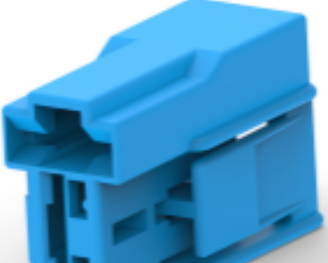
 <p>TE Part # 170456-1 PL 250 AUTOMOTIVE REC 12-10 0.40 X 21 BR</p>	 <p>TE Part # 170454-1 PL 250 AUTOMOTIVE REC 18-14 0.40 X 21 BR</p>	 <p>TE Part # 170456-2 PL 250 AM REC 12-10 0.40 X 21 PRE-TPBR</p>	 <p>TE Part # 170452-1 PL 250 AM REC 22-20 AWG 0.406 X 21 BR</p>
 <p>TE Part # 170452-2 PL 250 AUTOMOTIVE REC 22-20 AWG PRE TPBR</p>	 <p>TE Part # 170454-2 PL 250 AM REC 18-14 0.40 X 21 PRE-TPBR</p>	 <p>TE Part # 1969877-1 187 HIGH TEMP POS LOCK HSG LCP</p>	 <p>TE Part # 926319-1 PL 250 REC HSG 2P NYLON BLACK</p>
 <p>TE Part # 927389-1 PL 3P HOUSING PA66 BLACK</p>	 <p>TE Part # 927422-1 POSITIVE LOCK 3P HOUSING PA6.6 BLACK</p>	 <p>TE Part # 1-1743206-2 250 FLAG P-LOCK HSG 2P 12.0 BLK GWT</p>	 <p>TE Part # 100100-1 2 POS POSITIVE LOCK (PL) HOUSING GWT</p>
 <p>TE Part # 172434-6 250 P-LOCK 2P HSG T-TYPE BLUE</p>	 <p>TE Part # 1969717-3 HSG, REC., POS-LOCK, MK I 2P, 6.35 SR YEL</p>		

Also in the Series | **Positive Lock 250**



Automotive Terminals(1)



Crimp Terminal Housings(193)



Insertion & Extraction Tools(3)



Insulation Boots & Sleeves(4)



Quick Disconnects(186)

Customers Also Bought



TE Part #368501-1
MULTILOCK, CONNECTOR HOUSING



TE Part #2-1355397-3
4POS MQS REC COD B

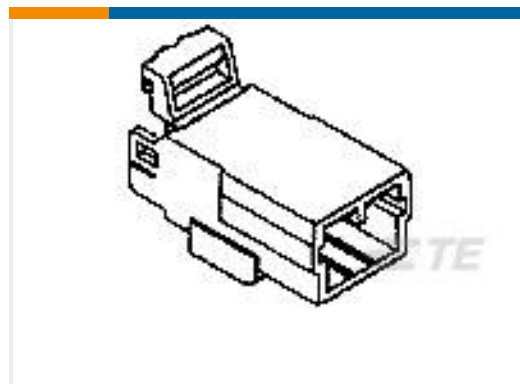

TE Part #174929-1
070 MLC W-W CAP HSG 4P NATURAL



TE Part #2134557-2
8POS MQS REC



TE Part #2391056-2
12POS,TH 025,REC HSG,UNSLD,COD A

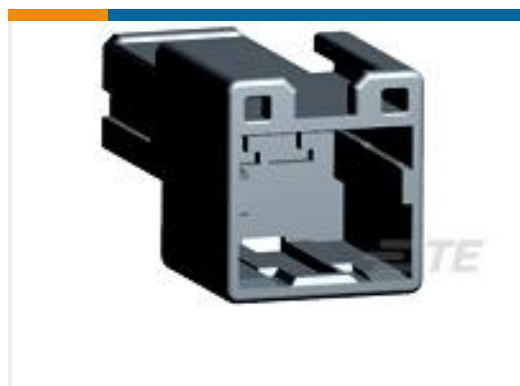

TE Part #936236-5
090III 2P CAP ASSY YELLOW



TE Part #368036-1
CLIP FOR 070 & EJ MK-II(DAEWOO)

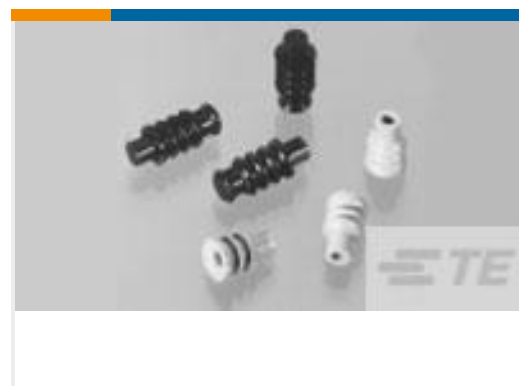

TE Part #1-368280-1
WIRE SEAL FOR EJ MK-II(+) RED

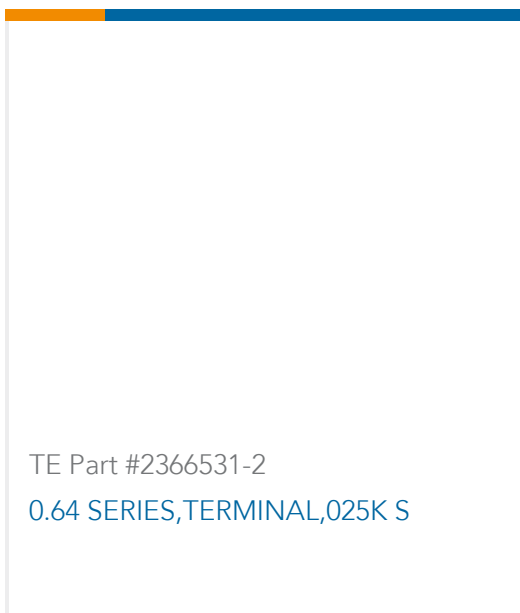

TE Part #2366531-2
0.64 SERIES,TERMINAL,025K S

Documents



Product Drawings

250 HSG. REC. 6mm 2P BLACK

English

CAD Files

3D PDF

3D

Customer View Model

[ENG_CVM_CVM_172864-2_G.2d_dxf.zip](#)

English

Customer View Model

[ENG_CVM_CVM_172864-2_G.3d_igs.zip](#)

English

Customer View Model

[ENG_CVM_CVM_172864-2_G.3d_stp.zip](#)

English

By downloading the CAD file I accept and agree to the [Terms and Conditions](#) of use.

Product Specifications

Crimping of 250 Series Tab and Receptacle Contacts

Japanese

Application Specification

Japanese

Crimping of 250 Series, Automotive Positive Lock Receptacle Contact

English

Application Specification

English

Product Environmental Compliance

Product Compliance

English

Product Compliance

English

Agency Approvals

CSA Certificate

English