

172061-3 ✓ ACTIVE



Standard Drawer

TE Internal #: 172061-3

Housing, Plug, Wire-to-Board / Wire-to-Wire, 12 Position, .197 in [5 mm] Centerline, Crimp, 2 Row, Blue, Mating Retention, Standard Drawer

[View on TE.com >](#)

Connectors > PCB Connectors > Wire-to-Board Connectors > Wire-to-Board Connector Assemblies & Housings > Standard Drawer Plug Housings



Connector Product Type: **Housing**

Connector & Housing Type: **Plug**

Connector System: **Wire-to-Board, Wire-to-Wire**

Number of Positions: **12**

Centerline (Pitch): **5 mm [.197 in]**

[All Standard Drawer Plug Housings \(15\)](#)

Features

Product Type Features

Connector Product Type	Housing
Connector & Housing Type	Plug
Connector System	Wire-to-Board, Wire-to-Wire
Sealable	No
Connector & Contact Terminates To	Wire & Cable

Configuration Features

Number of Signal Positions	4
Number of Positions	12
Number of Rows	2

Electrical Characteristics

Operating Voltage	250 V
-------------------	-------

Body Features

Drawer Style	Miniature Power
Primary Product Color	Blue

Contact Features

--	--



Contact Type	Pin
Contact Base Material	Phosphor Bronze
Contact Current Rating (Max)	15 A

Termination Features

Termination Method to Wire & Cable	Crimp
------------------------------------	-------

Mechanical Attachment

Panel Mount Feature	With
PCB Mount Retention	Without
Mating Retention	With
Connector Mounting Type	Panel Mount

Housing Features

Housing Material	PBT GF
Centerline (Pitch)	5 mm [.197 in]

Dimensions

Connector Length	61.2 mm [2.41 in]
Connector Height	26.3 mm [1.035 in]
Connector Width	32.5 mm
Wire Size	.22 mm ² , .22 – 2.18 mm ²
Row-to-Row Spacing	13.3 mm [.524 in]

Usage Conditions

Operating Temperature Range	-20 – 120 °C [-4 – 248 °F]
-----------------------------	----------------------------

Operation/Application

Circuit Application	Power & Signal
---------------------	----------------

Industry Standards

UL Flammability Rating	UL 94V-0
------------------------	----------

Packaging Features

Packaging Method	Box & Carton
------------------	--------------

Other

Discrete Wire Connector Comment	Mating Hsg - 5172069- Contacts - 170311, 170312, 170484, 170313, 170314, 170488
---------------------------------	---

Product Compliance









[For compliance documentation, visit the product page on TE.com>](#)

EU RoHS Directive 2011/65/EU	Compliant
EU ELV Directive 2000/53/EC	Compliant
China RoHS 2 Directive MIIT Order No 32, 2016	No Restricted Materials Above Threshold
EU REACH Regulation (EC) No. 1907/2006	Current ECHA Candidate List: JUNE 2023 (235) Candidate List Declared Against: JUNE 2023 (235) Does not contain REACH SVHC
Halogen Content	Not Low Halogen - contains Br or Cl > 900 ppm.
Solder Process Capability	Not applicable for solder process capability

Product Compliance Disclaimer

This information is provided based on reasonable inquiry of our suppliers and represents our current actual knowledge based on the information they provided. This information is subject to change. The part numbers that TE has identified as EU RoHS compliant have a maximum concentration of 0.1% by weight in homogenous materials for lead, hexavalent chromium, mercury, PBB, PBDE, DBP, BBP, DEHP, DIBP, and 0.01% for cadmium, or qualify for an exemption to these limits as defined in the Annexes of Directive 2011/65/EU (RoHS2). Finished electrical and electronic equipment products will be CE marked as required by Directive 2011/65/EU. Components may not be CE marked. Additionally, the part numbers that TE has identified as EU ELV compliant have a maximum concentration of 0.1% by weight in homogenous materials for lead, hexavalent chromium, and mercury, and 0.01% for cadmium, or qualify for an exemption to these limits as defined in the Annexes of Directive 2000/53/EC (ELV). Regarding the REACH Regulation, the information TE provides on SVHC in articles for this part number is based on the latest European Chemicals Agency (ECHA) 'Guidance on requirements for substances in articles' posted at this URL: <https://echa.europa.eu/guidance-documents/guidance-on-reach>

Compatible Parts

 <p>TE Part # 170313-1 DRAWER CONN.CONTACT</p>	 <p>TE Part # 170485-1 DRAWER CONN LP</p>	 <p>TE Part # 170312-1 POWER CONN.CONTACT</p>	 <p>TE Part # 170311-1 CONTACT FOR DRAWER CONN</p>
 <p>TE Part # 170484-1 CONTACT FOR DRAWER CONNECTOR</p>	 <p>TE Part # 172653-3 DRAWER CONN MALE ASSY 12P</p>	 <p>TE Part # 5172069-3 DRAWER CONN 12P FEMALE</p>	 <p>TE Part # 170314-1 DRAWER CONN.CONTACT</p>

Also in the Series | Standard Drawer



Wire-to-Board Connector Assemblies
& Housings(20)

Customers Also Bought



TE Part #172063-3
DRAWER CONN 8P MALE



TE Part #1-66098-8
Strip Pin and Socket Contacts, Type III

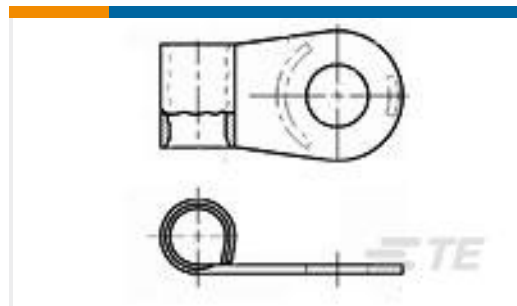

TE Part #321275
TERMINAL,SOLIS FLAG R 4 1/4



TE Part #211758-1
PLUG HSG,12 POSN,METRIMATE



TE Part #211759-1
RECEPT HSG,12 POSN,METRIMATE



TE Part #4-1879071-6
THS50 390R 5%

Documents

Product Drawings

DRAWER CONN 12P MALE

Japanese

CAD Files

3D PDF

3D

Customer View Model

[ENG_CVM_CVM_172061-3_G.2d_dxf.zip](#)

English

Customer View Model

[ENG_CVM_CVM_172061-3_G.3d_igs.zip](#)

English

Customer View Model

[ENG_CVM_CVM_172061-3_G.3d_stp.zip](#)



English

By downloading the CAD file I accept and agree to the [Terms and Conditions](#) of use.

Datasheets & Catalog Pages

[POWER_CONNECTORS_CATALOG_SEC02_CABLE_MOUNTED](#)

English

[Low Power Drawer Connectors QRG](#)

English

Product Specifications

[Crimping Drawer Connector Contacts](#)

English

[Application Specification](#)

English

[Terminating AMP MTEI Connector](#)

English

[Application Specification](#)

English

Agency Approvals

[UL](#)

English