

171432-1 ✓ ACTIVE

FASTIN-FASTON | FASTIN-FASTON 250

TE Internal #: 171432-1

Crimp Terminal Housings, Receptacle, Receptacle, 6 Position, Flag, Natural, Nylon, Mating Alignment, Panel Mount, Carton, FASTIN-FASTON 250

[View on TE.com >](#)



Terminals & Splices > Terminal Housings, Insulation Sleeves & Blocks > Crimp Terminal Housings



Terminal Type: **Receptacle**

Connector & Housing Type: **Receptacle**

Number of Positions: **6**

Terminal Orientation: **Flag**

Primary Product Color: **Natural**

## Features

### Product Type Features

Sealable	No
Connector & Contact Terminates To	Wire & Cable
Connector & Housing Type	Receptacle

### Configuration Features

Number of Positions	6
---------------------	---

### Body Features

Primary Product Color	Natural
-----------------------	---------

### Contact Features

Terminal Type	Receptacle
Terminal Orientation	Flag
Contact Mating Retention	Without

### Mechanical Attachment

Mating Alignment	With
------------------	------



Connector Mounting Type Panel Mount

### Housing Features

Housing Material	Nylon
Centerline (Pitch)	9.2 mm[.362 in]

### Dimensions

Product Length	24 mm[.945 in]
----------------	----------------

### Usage Conditions

Operating Temperature Range	-40 – 105 °C[-40 – 221 °F]
-----------------------------	----------------------------

### Packaging Features

Packaging Quantity	500
Packaging Method	Carton

## Product Compliance

[For compliance documentation, visit the product page on TE.com>](#)

EU RoHS Directive 2011/65/EU	Compliant
EU ELV Directive 2000/53/EC	Compliant
China RoHS 2 Directive MIIT Order No 32, 2016	No Restricted Materials Above Threshold
EU REACH Regulation (EC) No. 1907/2006	Current ECHA Candidate List: JUNE 2023 (235) Candidate List Declared Against: JAN 2021 (211) Does not contain REACH SVHC
Halogen Content	Low Halogen - Br, Cl, F, I < 900 ppm per homogenous material. Also BFR/CFR/PVC Free
Solder Process Capability	Not applicable for solder process capability

#### Product Compliance Disclaimer

This information is provided based on reasonable inquiry of our suppliers and represents our current actual knowledge based on the information they provided. This information is subject to change. The part numbers that TE has identified as EU RoHS compliant have a maximum concentration of 0.1% by weight in homogenous materials for lead, hexavalent chromium, mercury, PBB, PBDE, DBP, BBP, DEHP, DIBP, and 0.01% for cadmium, or qualify for an exemption to these limits as defined in the Annexes of Directive 2011/65/EU (RoHS2). Finished electrical and electronic equipment products will be CE marked as required by Directive 2011/65/EU. Components may not be CE marked. Additionally, the part numbers that TE has identified as EU ELV compliant have a maximum concentration of 0.1% by weight in homogenous materials for lead, hexavalent chromium, and mercury, and 0.01% for cadmium, or qualify for an exemption to these limits as defined in the Annexes of Directive 2000/53/EC (ELV). Regarding the REACH Regulation, the information TE provides on SVHC in articles for this part number is based on the latest European Chemicals Agency (ECHA) 'Guidance on requirements for substances in articles' posted at this URL: <https://echa.europa.eu/guidance-documents/guidance-on-reach>

## Compatible Parts



TE Part # 170258-2  
FF 250 REC 14-12AWG TPBR  
REREELING



TE Part # 170258-1  
FF 250 REC 14-12AWG BR REREELING



TE Part # 1-171432-2  
FF 312 REC HSG 6P NYLON RED



TE Part # 1-171432-5  
FF 312 REC HSG 6P NYLON GREEN



TE Part # 1-171432-9  
FF 312 REC HSG 6P NYLON BLACK

## Also in the Series | FASTIN-FASTON 250

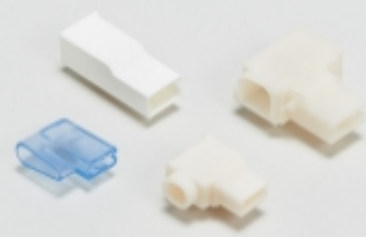

Crimp Terminal Housings(211)



Insertion & Extraction Tools(2)



PCB Terminals(2)



Quick Disconnects(254)

## Customers Also Bought



TE Part #1-353717-2  
DYNAMIC D-3 REC CONT. 3L AU 0.38  
L/P

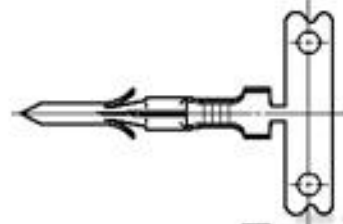

TE Part #350629-5  
.062 COMM P&S PIN AUNI/BR



TE Part #175024-1  
250 PL EX REC. 15-10AWG PTBR



TE Part #170048-2  
110 FASTON,REC.,24-20 AWG,TPBR

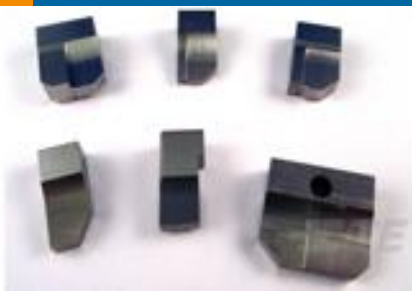

TE Part #4-1333205-8  
ANVIL, COMBINATION .090



TE Part #171364-1  
MIC PLUG 21P



TE Part #172096-1  
MIC CAP 9P W-W W/F

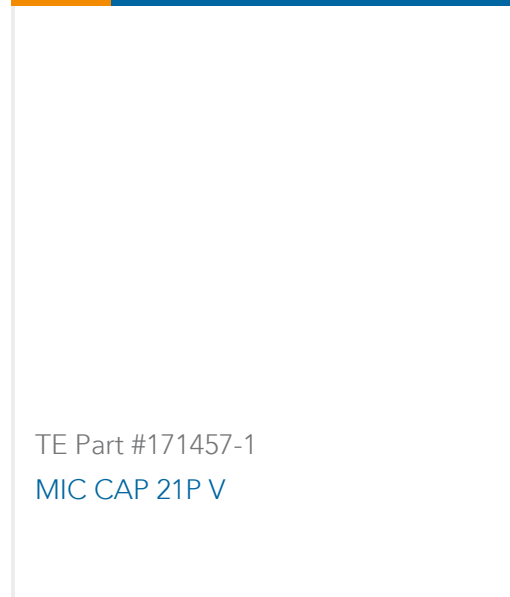

TE Part #171457-1  
MIC CAP 21P V

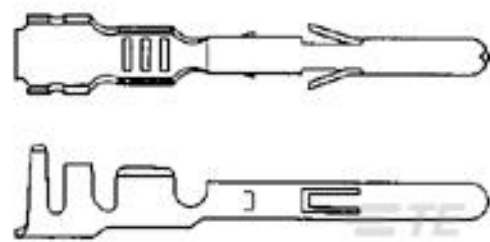

TE Part #170113-1  
.079 (2.0) DIA PIN RECP L.P.



TE Part #170112-1  
.079 (2.0) DIA PIN RECP L.P.

## Documents

### Product Drawings

FF 250 REC HSG 6P NYLON NAT

Japanese

### CAD Files

3D PDF

3D

Customer View Model

[ENG\\_CVM\\_CVM\\_171432-1\\_C.2d\\_dxf.zip](#)

English

Customer View Model

[ENG\\_CVM\\_CVM\\_171432-1\\_C.3d\\_igs.zip](#)

English

Customer View Model

[ENG\\_CVM\\_CVM\\_171432-1\\_C.3d\\_stp.zip](#)

English

By downloading the CAD file I accept and agree to the [Terms and Conditions](#) of use.

### Datasheets & Catalog Pages

White Paper: Nylon Discoloration

English

### Product Specifications

Application Specification

English

### Product Environmental Compliance

Product Compliance



English

[Product Compliance](#)

English

---

[Agency Approvals](#)

[CSA Certificate](#)

English