

170342-2 ✓ ACTIVE

FASTON | FASTON 250

TE Internal #: 170342-2

Quick Disconnects, Receptacle, 20 – 14 AWG Wire Size, .51 – 2.08 mm² Wire Size, Mating Tab Width 6.35 mm [.25 in], Straight, Brass, FASTON 250

[View on TE.com >](#)



Terminals & Splices > Quick Disconnects

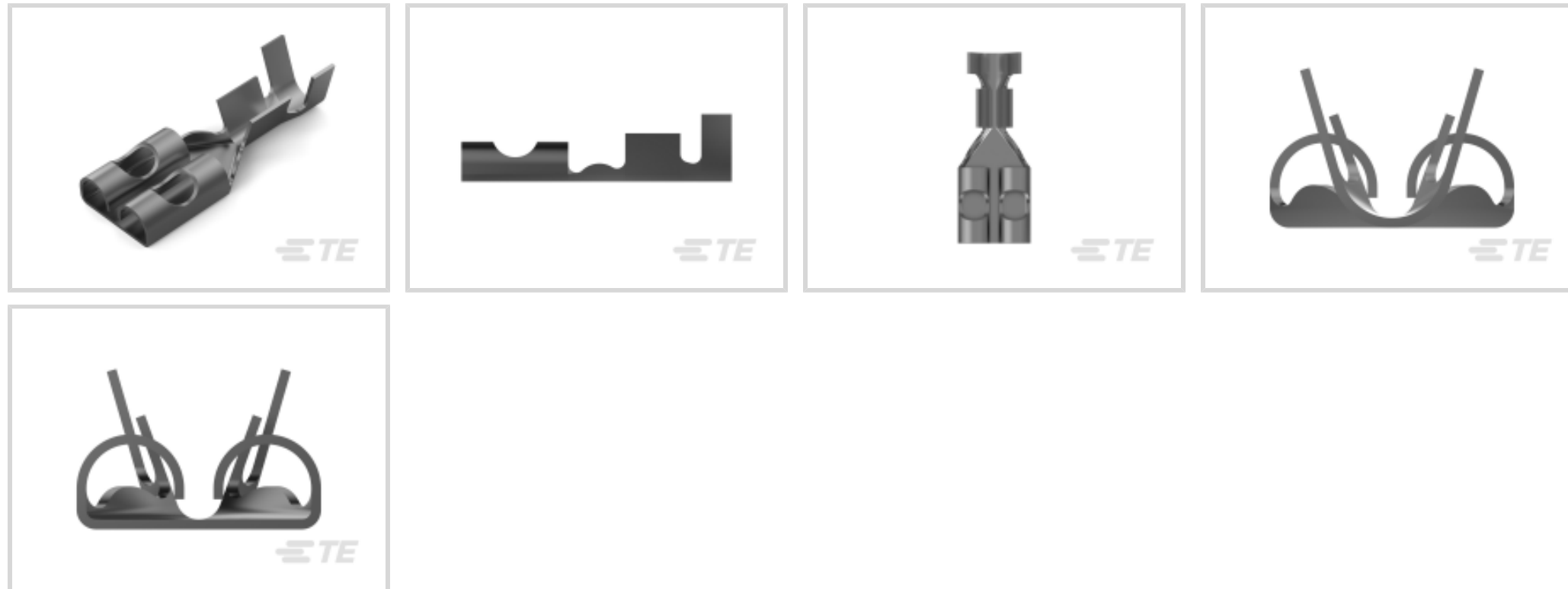

Quick Disconnect Terminal Type: **Receptacle**

Wire Size: .51 – 2.08 mm²

Mating Tab Width: 6.35 mm [.25 in]

Mating Tab Thickness: .61 mm [.024 in]

Features

Product Type Features

Insertion Force	Normal
-----------------	--------

Configuration Features

Connection Capacity	Single
Compatible With Wire & Cable Type	Discrete Wire

Contact Features

Quick Disconnect Terminal Type	Receptacle
Mating Tab Width	6.35 mm [.25 in]
Mating Tab Thickness	.61 mm [.024 in]
Terminal Orientation	Straight
Contact Base Material	Brass
Terminal Plating Material	Tin
Crimp Type	F-Crimp
Barrel Type	Open

Termination Features

--	--



Product Terminates To	Wire & Cable
-----------------------	--------------

Mechanical Attachment

Extraction Force	4.9 – 39.2 Newton
------------------	-------------------

Wire Insulation Support	With
-------------------------	------

Dimensions

Terminal Material Thickness	.3 mm[.012 in]
-----------------------------	----------------

Product Length	19.6 mm[.77 in]
----------------	-----------------

Compatible Insulation Diameter Range	2.21 – 3.4 mm[.087 – .134 in]
--------------------------------------	-------------------------------

Wire Size	.51 – 2.08 mm ²
-----------	----------------------------

Usage Conditions

Insulation Option	Uninsulated
-------------------	-------------

Operating Temperature Range	-40 – 110 °C[-40 – 230 °F]
-----------------------------	----------------------------

Packaging Features

Packaging Quantity	4000
--------------------	------

Packaging Method	Strip/Reel
------------------	------------

Other

Line	FASTON .250
------	-------------

Product Compliance

[For compliance documentation, visit the product page on TE.com>](#)

EU RoHS Directive 2011/65/EU	Compliant
------------------------------	-----------

EU ELV Directive 2000/53/EC	Compliant
-----------------------------	-----------

China RoHS 2 Directive MIIT Order No 32, 2016	No Restricted Materials Above Threshold
---	---

EU REACH Regulation (EC) No. 1907/2006	Current ECHA Candidate List: JUNE 2023 (235) Candidate List Declared Against: JUNE 2023 (235) Does not contain REACH SVHC
--	---

Halogen Content	Low Halogen - Br, Cl, F, I < 900 ppm per homogenous material. Also BFR/CFR/PVC Free
-----------------	---

Solder Process Capability	Not applicable for solder process capability
---------------------------	--

Product Compliance Disclaimer

This information is provided based on reasonable inquiry of our suppliers and represents our current actual knowledge based on the information they provided. This information is subject to change. The part numbers that TE has identified as EU RoHS compliant have a maximum concentration of 0.1% by weight in homogenous materials for lead, hexavalent chromium, mercury, PBB, PBDE, DBP, BBP, DEHP, DIBP, and 0.01% for cadmium, or qualify for an exemption to these limits as defined in the Annexes of Directive 2011/65/EU (RoHS2). Finished electrical and electronic equipment products will be CE marked as required by Directive 2011/65/EU. Components may not be CE marked. Additionally, the part numbers that TE has identified as EU ELV compliant have a maximum concentration of 0.1% by weight in homogenous materials for lead, hexavalent chromium, and mercury, and 0.01% for cadmium, or qualify for an exemption to these limits as defined in the Annexes of Directive 2000/53/EC (ELV). Regarding the REACH Regulation, the information TE provides on SVHC in articles for this part number is based on the latest European Chemicals Agency (ECHA) 'Guidance on requirements for substances in articles' posted at this URL: <https://echa.europa.eu/guidance-documents/guidance-on-reach>

Compatible Parts



TE Part # 2150034-1
OCEAN_2.0_APPPLICATOR-E-110F180F



KIT
REPRESENTATION ONLY
TE Part # 7-2150034-7
OCEAN_2.0_SPARE_PART_KIT-110F180F



TE Part # 2150034-2
OCEAN_2.0_APPPLICATOR-E-110F180FA



TE Part # 2-2150034-1
OCEAN_2.0_APPPLICATOR-E-110F180FA

Also in the Series | FASTON 250



Compression Connectors(4)

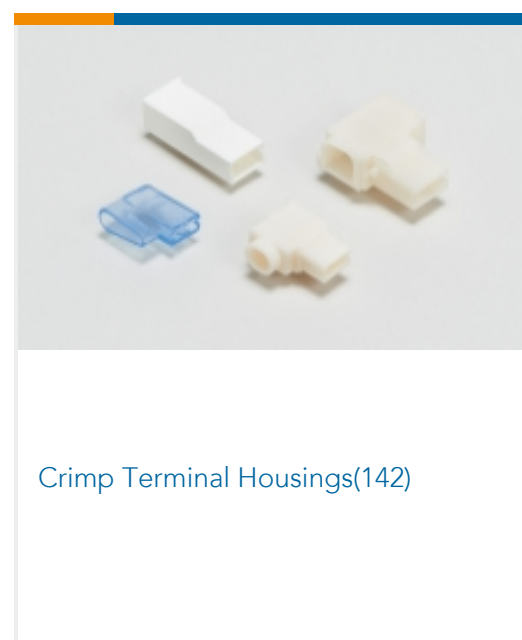

Crimp Terminal Housings(142)

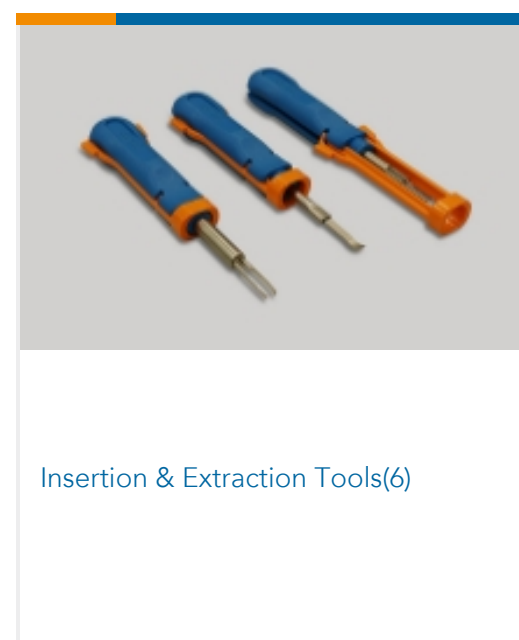

Insertion & Extraction Tools(6)



Magnet Wire Terminals(1)

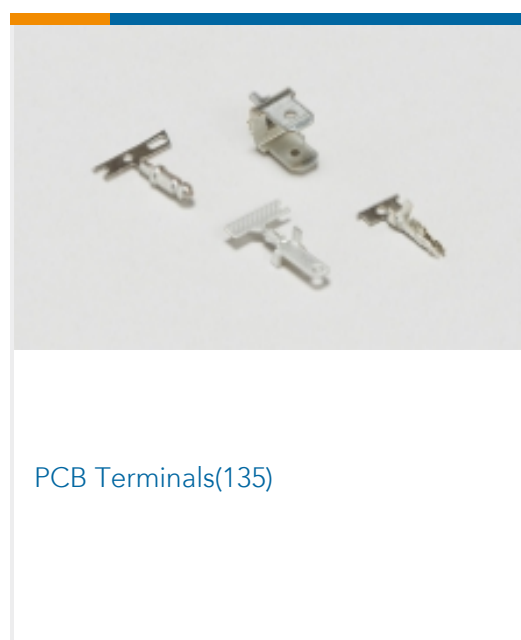

PCB Terminals(135)

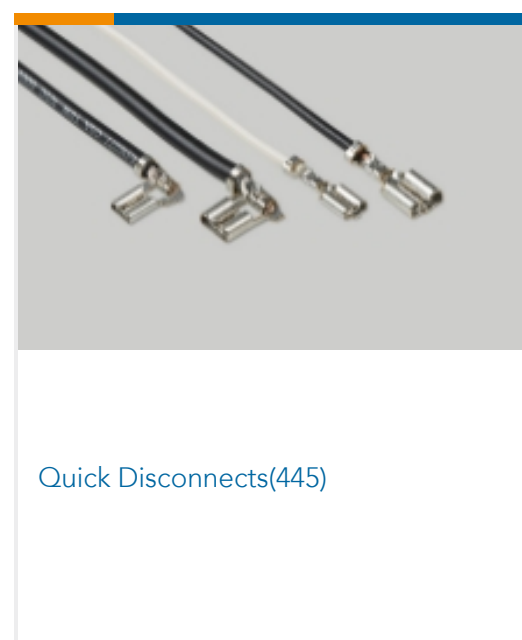

Quick Disconnects(445)



Splices(4)

Customers Also Bought

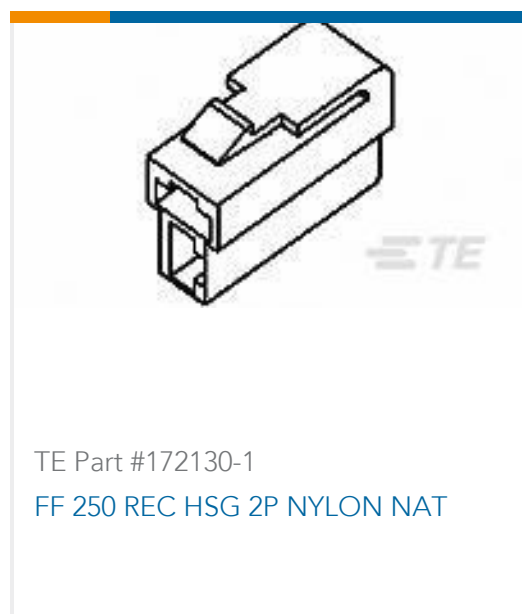

Documents

Product Drawings

250 FASTON, REC., 20-14 AWG, TPBR

English

CAD Files

3D PDF

3D

Customer View Model

[ENG_CVM_CVM_170342-2_L_c-170342-2-l.2d_dxf.zip](#)

English

Customer View Model

[ENG_CVM_CVM_170342-2_L_c-170342-2-l.3d_igs.zip](#)

English

Customer View Model

[ENG_CVM_CVM_170342-2_L_c-170342-2-l.3d_stp.zip](#)

English

By downloading the CAD file I accept and agree to the [Terms and Conditions](#) of use.

Product Specifications



Crimping of 250 Series Tab and Receptacle Contacts

Japanese

Application Specification

Japanese

Application Specification

Japanese

Crimping of 250 Series Tab and Receptacle Contacts

Japanese

Product Environmental Compliance

Product Compliance Document

English

Product Compliance Document

English