



[Positive Lock](#) | [Positive Lock 250](#)

TE Internal #: 170234-2

Quick Disconnects, Receptacle, 12 – 10 AWG Wire Size, 3.31 – 5.26 mm² Wire Size, Mating Tab Width 6.35 mm [.25 in], Straight, Brass, Positive Lock 250

[View on TE.com >](#)

Terminals & Splices > Quick Disconnects



Quick Disconnect Terminal Type: **Receptacle**

Wire Size: **3.31 – 5.26 mm²**

Mating Tab Width: **6.35 mm [.25 in]**

Mating Tab Thickness: **.81 mm [.032 in]**

Features

Product Type Features

Insertion Force	Low
-----------------	-----

Configuration Features

Connection Capacity	Single
Compatible With Wire & Cable Type	Discrete Wire

Contact Features

Quick Disconnect Terminal Type	Receptacle
Mating Tab Width	6.35 mm [.25 in]
Mating Tab Thickness	.81 mm [.032 in]
Terminal Orientation	Straight
Contact Base Material	Brass
Terminal Plating Material	Tin
Crimp Type	F-Crimp
Barrel Type	Open

Termination Features

--	--



Product Terminates To	Wire & Cable
-----------------------	--------------

Mechanical Attachment

Wire Insulation Support	With
Mating Retention Type	Dimple

Dimensions

Terminal Material Thickness	.41 mm[.016 in]
Product Length	22.1 mm[.87 in]
Compatible Insulation Diameter Range	3.81 – 5.08 mm[.15 – .2 in]
Wire Size	3.31 – 5.26 mm ²

Usage Conditions

Insulation Option	Uninsulated
Operating Temperature Range	-40 – 110 °C[-40 – 230 °F]

Industry Standards

Agency/Standard	UL
-----------------	----

Packaging Features

Packaging Quantity	1500
Packaging Method	Strip/Reel

Product Compliance

[For compliance documentation, visit the product page on TE.com>](#)

EU RoHS Directive 2011/65/EU	Compliant
EU ELV Directive 2000/53/EC	Compliant
China RoHS 2 Directive MIIT Order No 32, 2016	No Restricted Materials Above Threshold
EU REACH Regulation (EC) No. 1907/2006	Current ECHA Candidate List: JUNE 2023 (235) Candidate List Declared Against: JUNE 2023 (235) Does not contain REACH SVHC
Halogen Content	Low Halogen - Br, Cl, F, I < 900 ppm per homogenous material. Also BFR/CFR/PVC Free
Solder Process Capability	Not applicable for solder process capability

Product Compliance Disclaimer

This information is provided based on reasonable inquiry of our suppliers and represents our current actual knowledge based on the information they provided. This information is subject to change. The part numbers that TE has identified as EU RoHS compliant have a maximum concentration of 0.1% by weight in homogenous materials for lead, hexavalent chromium, mercury, PBB, PBDE, DBP, BBP, DEHP, DIBP, and 0.01% for cadmium, or qualify for an exemption to these limits as defined in the Annexes of Directive 2011/65/EU (RoHS2). Finished electrical and electronic equipment products will be CE marked as required by Directive 2011/65/EU. Components may not be CE marked. Additionally, the part numbers that TE has identified as EU ELV compliant have a maximum concentration of 0.1% by weight in homogenous materials for lead, hexavalent chromium, and mercury, and 0.01% for cadmium, or qualify for an exemption to these limits as defined in the Annexes of Directive 2000/53/EC (ELV). Regarding the REACH Regulation, the information TE provides on SVHC in articles for this part number is based on the latest European Chemicals Agency (ECHA) 'Guidance on requirements for substances in articles' posted at this URL: <https://echa.europa.eu/guidance-documents/guidance-on-reach>

Compatible Parts



TE Part # 171809-2
POSITIVE LOCK (PL) HOUSING



TE Part # 2305570-1
Strip Terminal Cutter-Side Feed-No Crimp



TE Part # 171809-1
POSITIVE LOCK (PL) HOUSING



TE Part # 2151724-2
OCEAN_2.0_Applicator-S-140F220F



KIT
REPRESENTATION ONLY

TE Part # 7-2151724-7
OCEAN_2.0_SPARE_PART_KIT-140F220F

Also in the Series | Positive Lock 250

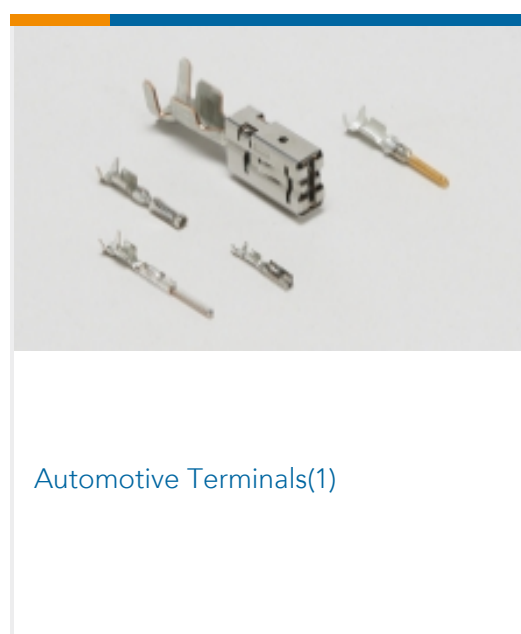

Automotive Terminals(1)

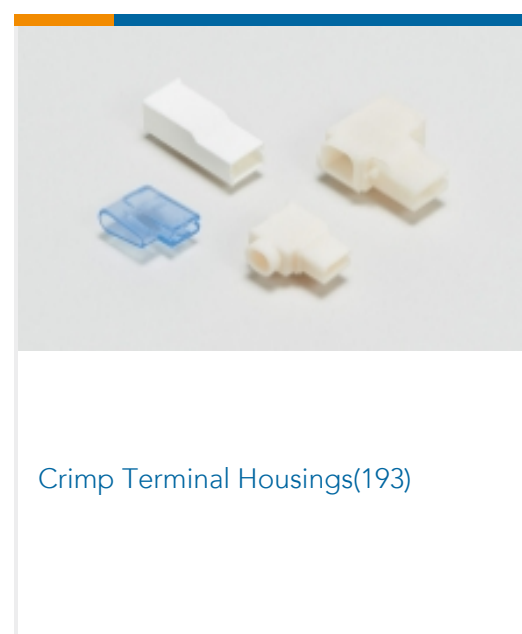

Crimp Terminal Housings(193)

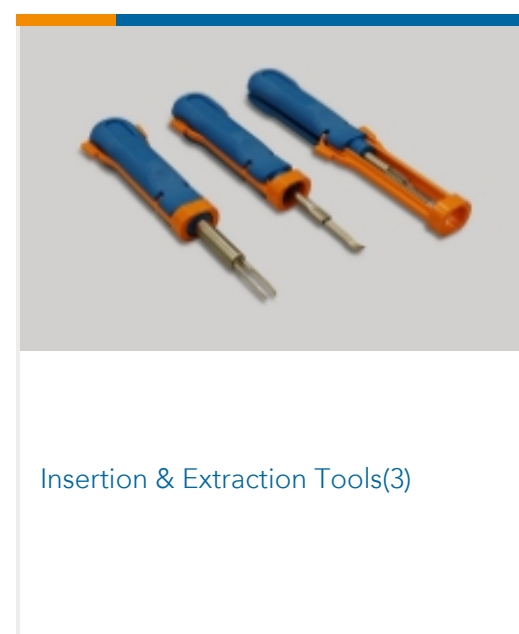

Insertion & Extraction Tools(3)



Insulation Boots & Sleeves(4)



Quick Disconnects(186)

Customers Also Bought



TE Part #1-173977-4
AMP COMMON TERMINATION
HOUSINGS

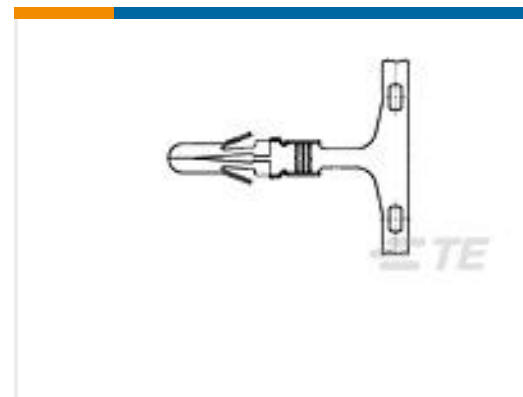

TE Part #880685-2
.140 DIA PIN



TE Part #1648384-1
708-73-01109=SA CONTACT,SKT



TE Part #2329362-6
PB ON/OFF RC BLK M1 TERM IP68
500MM LHS

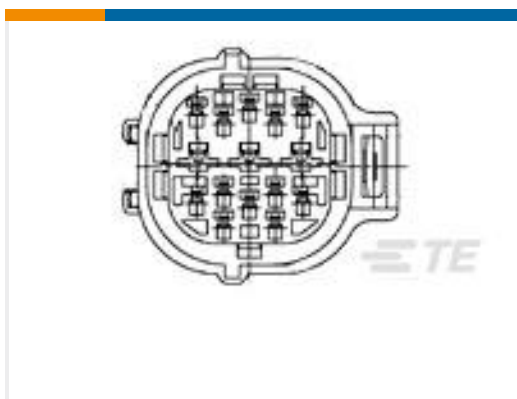

TE Part #2-85262-1
E-S MK-2(+) 15P PLUG ASSY

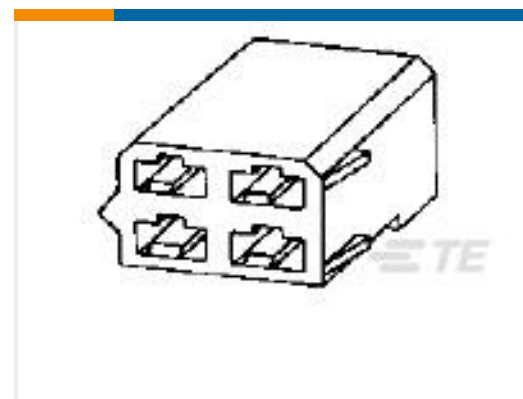

TE Part #880110
FASTON HOUSING RECEPTACLE
NAT NYLON



TE Part #1-163081-2
.062 PIN ASSY 3+



TE Part #2310344-1
1062-12-0166

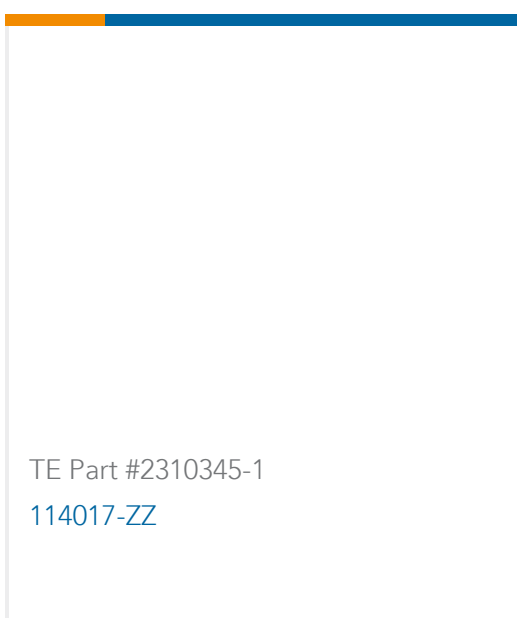

TE Part #2310345-1
114017-ZZ

Documents

Product Drawings

[PL 250 REC 12-10 AWG 0.406 X 42.3](#)

Japanese

CAD Files

Customer View Model

[ENG_CVM_CVM_170234-2_K.2d_dxf.zip](#)

English

[3D PDF](#)



3D

Customer View Model

[ENG_CVM_CVM_170234-2_K.3d_igs.zip](#)

English

Customer View Model

[ENG_CVM_CVM_170234-2_K.3d_stp.zip](#)

English

By downloading the CAD file I accept and agree to the [Terms and Conditions](#) of use.

Product Specifications

[Crimping of Positive Lock Receptacle Contact](#)

English

[Application Specification](#)

English