

170095-1 ✓ ACTIVE

FASTON | FASTON 250

TE Internal #: 170095-1

Quick Disconnects, Receptacle, 22 – 18 AWG Wire Size, .32 – .82 mm² Wire Size, Mating Tab Width 6.35 mm [.25 in], Straight, FASTON 250

[View on TE.com >](#)



Terminals & Splices > Quick Disconnects



Quick Disconnect Terminal Type: **Receptacle**

Wire Size: .32 – .82 mm²

Mating Tab Width: 6.35 mm [.25 in]

Mating Tab Thickness: .81 mm [.032 in]

Features

Product Type Features

Insertion Force	Normal
-----------------	--------

Configuration Features

Connection Capacity	Single
Compatible With Wire & Cable Type	Discrete Wire

Contact Features

Quick Disconnect Terminal Type	Receptacle
Mating Tab Width	6.35 mm [.25 in]
Mating Tab Thickness	.81 mm [.032 in]
Terminal Orientation	Straight
Contact Base Material	Phosphor Bronze
Terminal Plating Material	Tin
Crimp Type	F-Crimp
Barrel Type	Open

Termination Features

--	--



Product Terminates To	Wire & Cable
-----------------------	--------------

Mechanical Attachment

Extraction Force	24.5 Newton
------------------	-------------

Wire Insulation Support	With
-------------------------	------

Mating Retention Type	Dimple
-----------------------	--------

Dimensions

Terminal Material Thickness	.41 mm[.016 in]
-----------------------------	-----------------

Product Length	20.6 mm[.811 in]
----------------	------------------

Compatible Insulation Diameter Range	2.3 – 3.3 mm[.09 – .13 in]
--------------------------------------	----------------------------

Wire Size	.32 – .82 mm ²
-----------	---------------------------

Usage Conditions

Insulation Option	Uninsulated
-------------------	-------------

Operating Temperature Range	-40 – 110 °C[-40 – 230 °F]
-----------------------------	----------------------------

Industry Standards

Agency/Standard	CSA, UL
-----------------	---------

Packaging Features

Packaging Quantity	1000
--------------------	------

Packaging Method	Loose Piece/Carton
------------------	--------------------

Product Compliance

[For compliance documentation, visit the product page on TE.com>](#)

EU RoHS Directive 2011/65/EU	Compliant
------------------------------	-----------

EU ELV Directive 2000/53/EC	Compliant
-----------------------------	-----------

China RoHS 2 Directive MIIT Order No 32, 2016	No Restricted Materials Above Threshold
---	---

EU REACH Regulation (EC) No. 1907/2006	Current ECHA Candidate List: JUNE 2023 (235) Candidate List Declared Against: JUNE 2023 (235) Does not contain REACH SVHC
--	---

Halogen Content	Low Halogen - Br, Cl, F, I < 900 ppm per homogenous material. Also BFR/CFR/PVC Free
-----------------	---

Solder Process Capability	Not applicable for solder process capability
---------------------------	--

Product Compliance Disclaimer

This information is provided based on reasonable inquiry of our suppliers and represents our current actual knowledge based on the information they provided. This information is subject to change. The part numbers that TE has identified as EU RoHS compliant have a maximum concentration of 0.1% by weight in homogenous materials for lead, hexavalent chromium, mercury, PBB, PBDE, DBP, BBP, DEHP, DIBP, and 0.01% for cadmium, or qualify for an exemption to these limits as defined in the Annexes of Directive 2011/65/EU (RoHS2). Finished electrical and electronic equipment products will be CE marked as required by Directive 2011/65/EU. Components may not be CE marked. Additionally, the part numbers that TE has identified as EU ELV compliant have a maximum concentration of 0.1% by weight in homogenous materials for lead, hexavalent chromium, and mercury, and 0.01% for cadmium, or qualify for an exemption to these limits as defined in the Annexes of Directive 2000/53/EC (ELV). Regarding the REACH Regulation, the information TE provides on SVHC in articles for this part number is based on the latest European Chemicals Agency (ECHA) 'Guidance on requirements for substances in articles' posted at this URL: <https://echa.europa.eu/guidance-documents/guidance-on-reach>

Compatible Parts

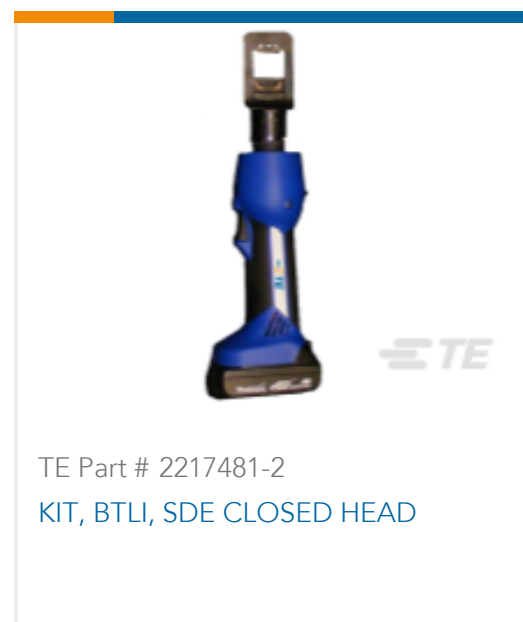

Also in the Series | FASTON 250

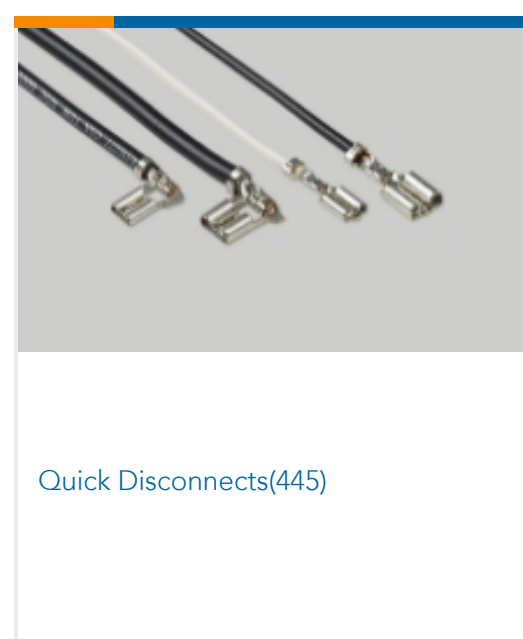
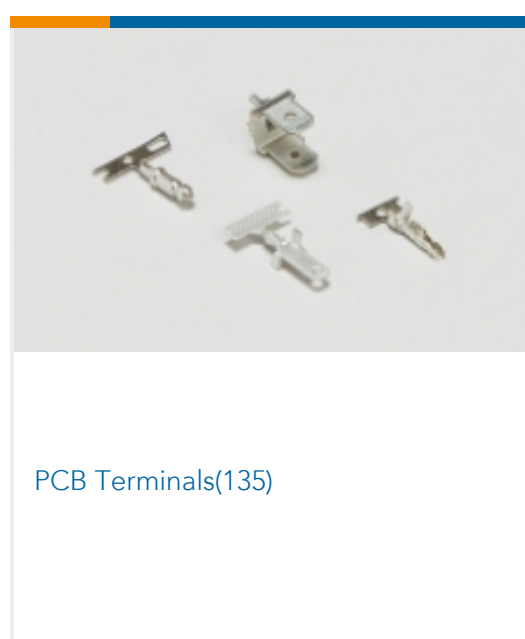
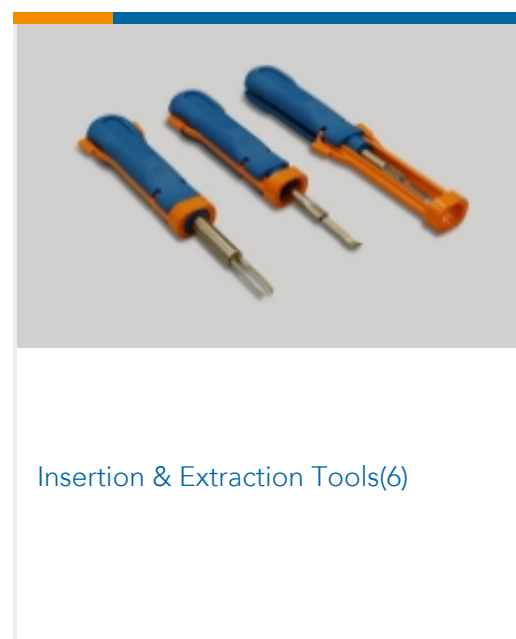
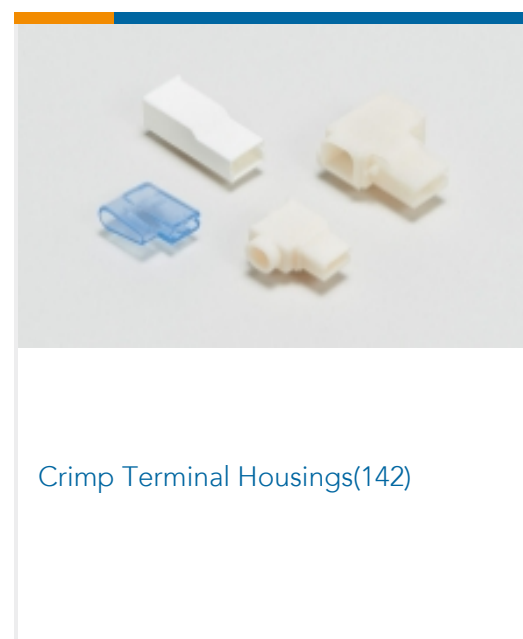
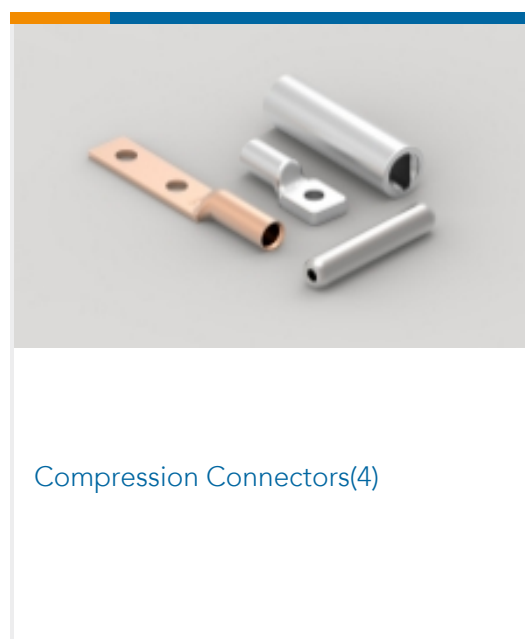

Customers Also Bought



TE Part #1-353908-3
CT REC HSG 13P CRIMP TYPE WHIT



TE Part #170038-2
187 FASTON,REC.,20-16 AWG,TPBR



TE Part #171822-9
EIS REC. HSG 9P-NATURAL



TE Part #34162
TERMINAL,PG R 16-14 1/4



TE Part #2822390-1
070 ECONOSEAL MARK-2 PLUG 3P
BLACK



TE Part #173630-6
070 MLC REC CONT 24-22

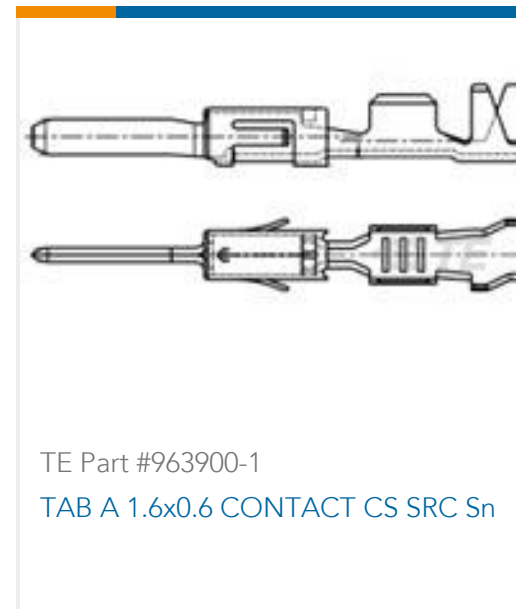

TE Part #963900-1
TAB A 1.6x0.6 CONTACT CS SRC Sn



TE Part #170823-2
250 FASTON SLEEVE,REC.,
TRANSPARENT



TE Part #453819-3
CRIMPER, WIRE-.062 WIDE F



TE Part #170038-4
187 FASTON,REC.,20-16 AWG,TPPB

Documents

Product Drawings

[250 FASTON,REC.,22-18 AWG,TPPB](#)

Japanese

CAD Files

Customer View Model

[ENG_CVM_CVM_170095-1_B.2d_dxf.zip](#)

English

[3D PDF](#)

3D

Customer View Model

[ENG_CVM_CVM_170095-1_B.3d_igs.zip](#)

English

Customer View Model

[ENG_CVM_CVM_170095-1_B.3d_stp.zip](#)

English

By downloading the CAD file I accept and agree to the [Terms and Conditions](#) of use.

Product Specifications



Application Specification

English

Product Environmental Compliance

Product Compliance

English

Product Compliance

English