

170032-1 ✓ ACTIVE

FASTON | FASTON 250

TE Internal #: 170032-1

Quick Disconnects, Receptacle, 20 – 14 AWG Wire Size, .5 – 2.5 mm<sup>2</sup> Wire Size, Mating Tab Width 6.35 mm [.25 in], Straight, Brass, FASTON 250

[View on TE.com >](#)



Terminals & Splices > Quick Disconnects

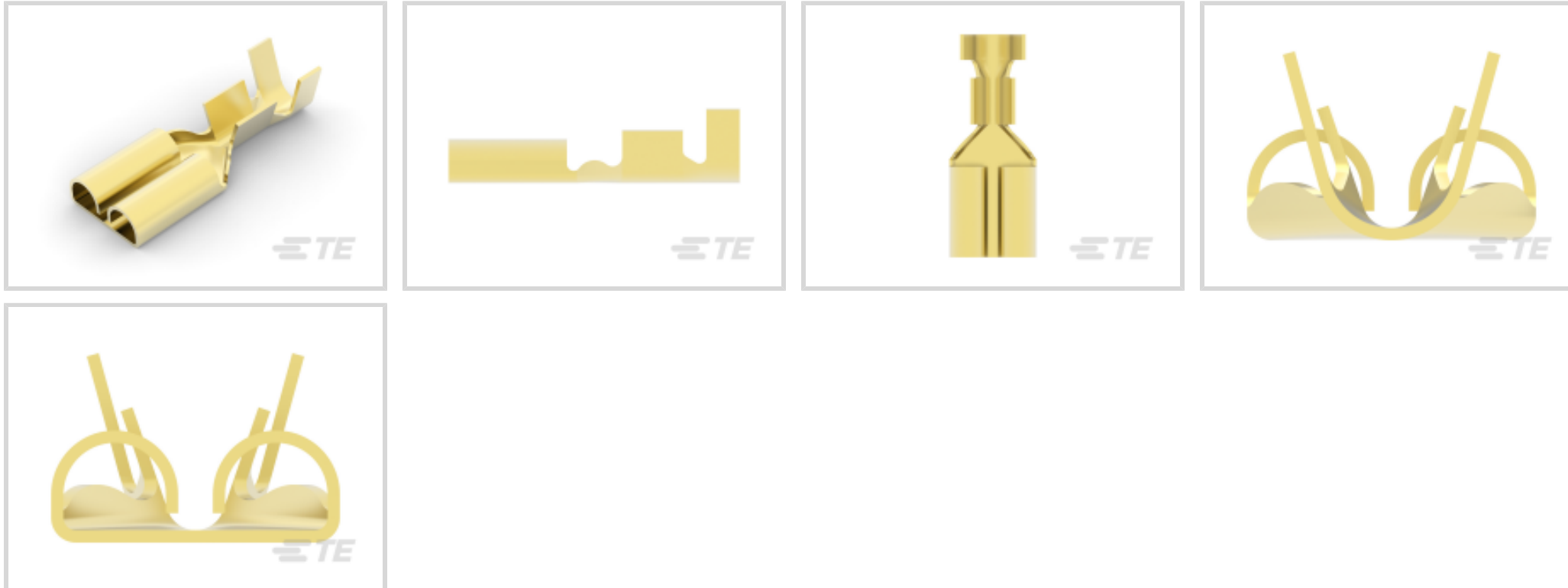

Quick Disconnect Terminal Type: **Receptacle**

Wire Size: **.5 – 2.5 mm<sup>2</sup>**

Mating Tab Width: **6.35 mm [.25 in]**

Mating Tab Thickness: **.81 mm [.032 in]**

## Features

### Product Type Features

Insertion Force	Normal
-----------------	--------

### Configuration Features

Connection Capacity	Single
Compatible With Wire & Cable Type	Discrete Wire

### Contact Features

Quick Disconnect Terminal Type	Receptacle
Mating Tab Width	6.35 mm [.25 in]
Mating Tab Thickness	.81 mm [.032 in]
Terminal Orientation	Straight
Contact Base Material	Brass
Terminal Plating Material	Unplated
Crimp Type	F-Crimp
Barrel Type	Open

### Termination Features

--	--



Product Terminates To	Wire & Cable
-----------------------	--------------

### Mechanical Attachment

Wire Insulation Support	With
Mating Retention Type	Dimple

### Dimensions

Terminal Material Thickness	.33 mm[.013 in]
Product Length	19.2 mm[.755 in]
Compatible Insulation Diameter Range	2.16 – 3.43 mm[.085 – .135 in]
Wire Size	.5 – 2.5 mm <sup>2</sup>

### Usage Conditions

Insulation Option	Uninsulated
Operating Temperature Range	-40 – 110 °C[-40 – 230 °F]

### Industry Standards

Agency/Standard	UL
-----------------	----

### Packaging Features

Packaging Quantity	6000
Packaging Method	Strip/Reel

### Product Compliance

[For compliance documentation, visit the product page on TE.com>](#)

EU RoHS Directive 2011/65/EU	Compliant
EU ELV Directive 2000/53/EC	Compliant
China RoHS 2 Directive MIIT Order No 32, 2016	No Restricted Materials Above Threshold
EU REACH Regulation (EC) No. 1907/2006	Current ECHA Candidate List: JUNE 2023 (235) Candidate List Declared Against: JUNE 2022 (224) Does not contain REACH SVHC
Halogen Content	Low Halogen - Br, Cl, F, I < 900 ppm per homogenous material. Also BFR/CFR/PVC Free
Solder Process Capability	Not applicable for solder process capability

Product Compliance Disclaimer

This information is provided based on reasonable inquiry of our suppliers and represents our current actual knowledge based on the information they provided. This information is subject to change. The part numbers that TE has identified as EU RoHS compliant have a maximum concentration of 0.1% by weight in homogenous materials for lead, hexavalent chromium, mercury, PBB, PBDE, DBP, BBP, DEHP, DIBP, and 0.01% for cadmium, or qualify for an exemption to these limits as defined in the Annexes of Directive 2011/65/EU (RoHS2). Finished electrical and electronic equipment products will be CE marked as required by Directive 2011/65/EU. Components may not be CE marked. Additionally, the part numbers that TE has identified as EU ELV compliant have a maximum concentration of 0.1% by weight in homogenous materials for lead, hexavalent chromium, and mercury, and 0.01% for cadmium, or qualify for an exemption to these limits as defined in the Annexes of Directive 2000/53/EC (ELV). Regarding the REACH Regulation, the information TE provides on SVHC in articles for this part number is based on the latest European Chemicals Agency (ECHA) 'Guidance on requirements for substances in articles' posted at this URL: <https://echa.europa.eu/guidance-documents/guidance-on-reach>

## Compatible Parts



TE Part # 170304-1  
250 FASTON,REC.,22-18 AWG,BR



TE Part # 170304-2  
250 FASTON,REC.,22-18 AWG,BR



TE Part # CAT-M9194-CH8172  
MULTILOCK, CONNECTOR HOUSING



TE Part # 2150034-1  
OCEAN\_2.0\_APPLICATOR-E-110F180F



**KIT**  
REPRESENTATION ONLY

TE Part # 7-2150034-7  
OCEAN\_2.0\_SPARE\_PART\_KIT-110F180F



TE Part # 724659-2  
EXT TOOL FOR POSITIVE .250



TE Part # 2150034-2  
OCEAN\_2.0\_APPLICATOR-E-110F180FA



TE Part # 346697-3  
250 FASTON,REC.,20-16 AWG,PB



TE Part # 7-2150034-1  
OCEAN\_2.0\_APPLICATOR-E-110F180F



TE Part # 7-2150034-2  
OCEAN\_2.0\_APPLICATOR-E-110F180FA



TE Part # 928962-3  
FF 250 TAB 1.0-2.5 MM2 0.38 X 12.2 CUSN4



TE Part # 2-2150034-1  
OCEAN\_2.0\_APPLICATOR-E-110F180F



TE Part # 2-2150034-2  
OCEAN\_2.0\_APPLICATOR-E-110F180FA

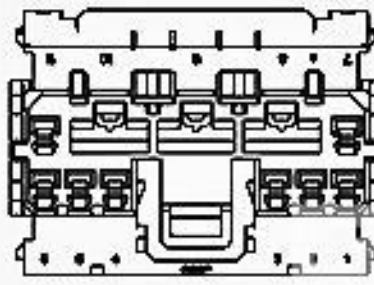

TE Part # 174925-4  
070 MLC W-W PLUG HSG 11P GREEN

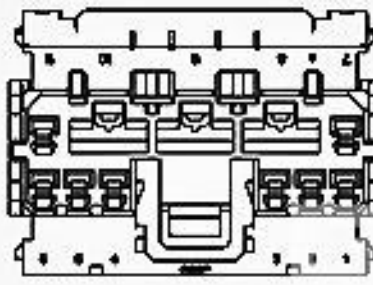

TE Part # 174925-5  
070 MLC W-W PLUG HSG 11P BLUE

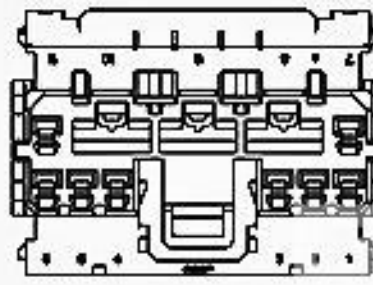

TE Part # 174926-5  
070 MLC W-W PLUG HSG 13P BLUE



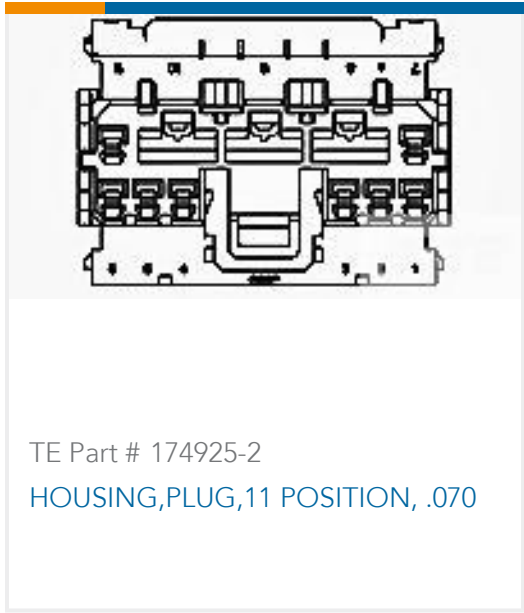
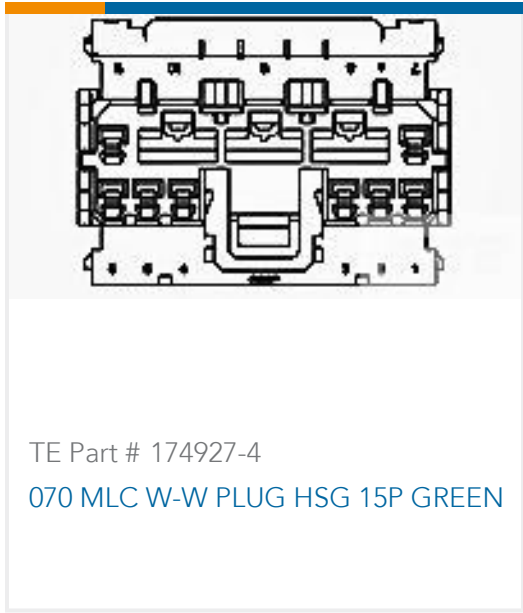

Also in the Series | **FASTON 250**

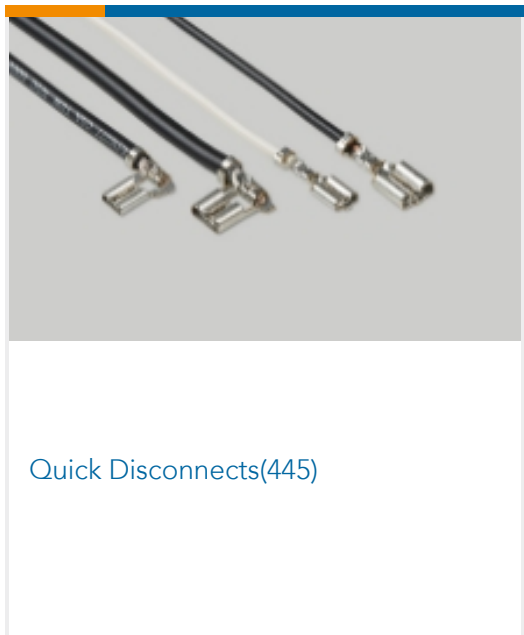
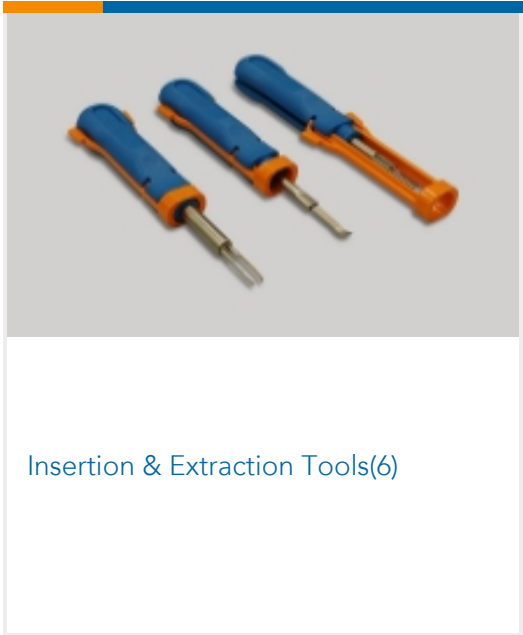
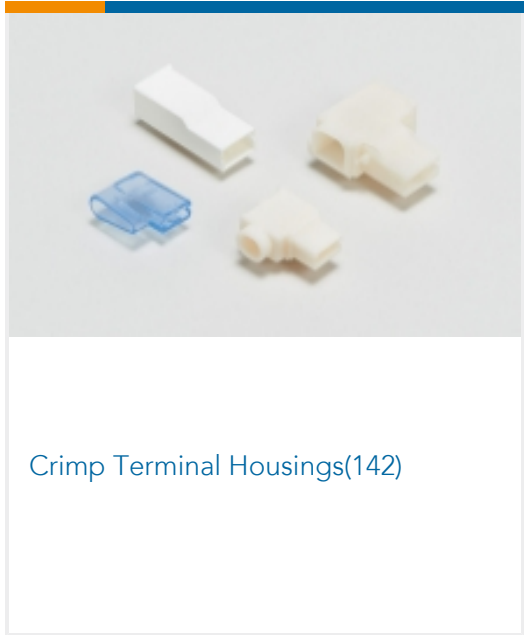
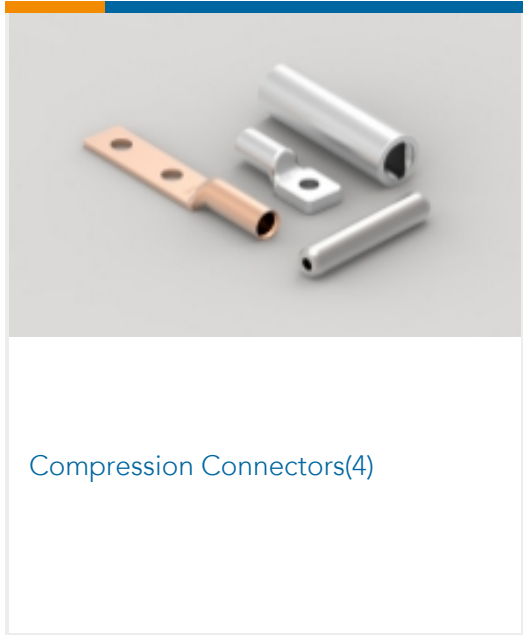

Customers Also Bought

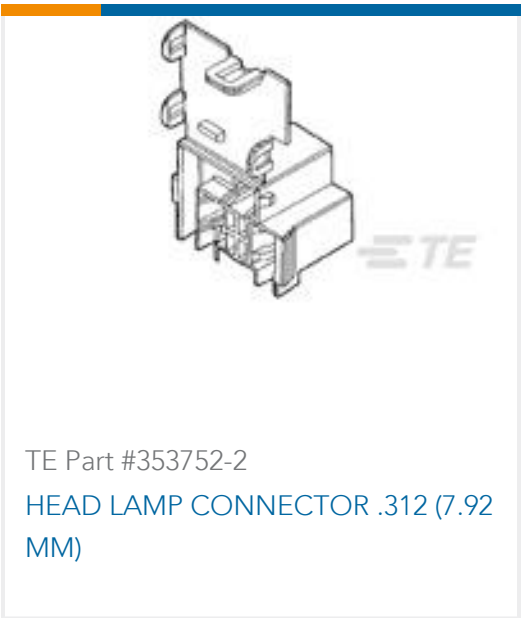
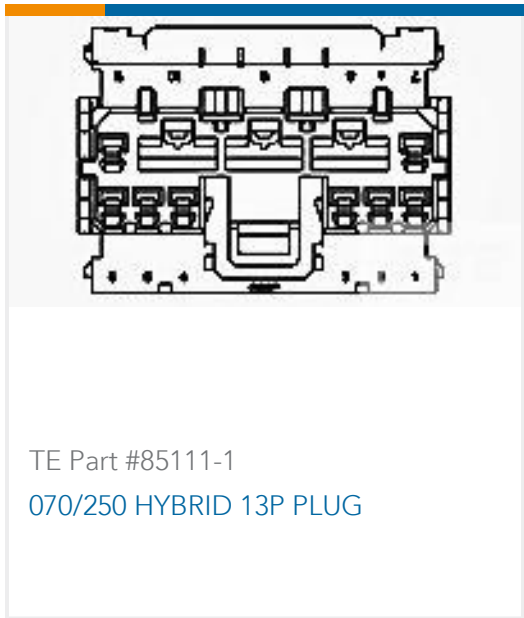
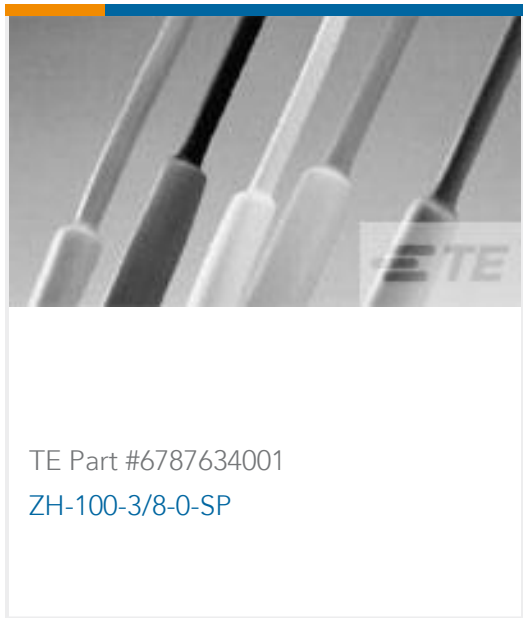
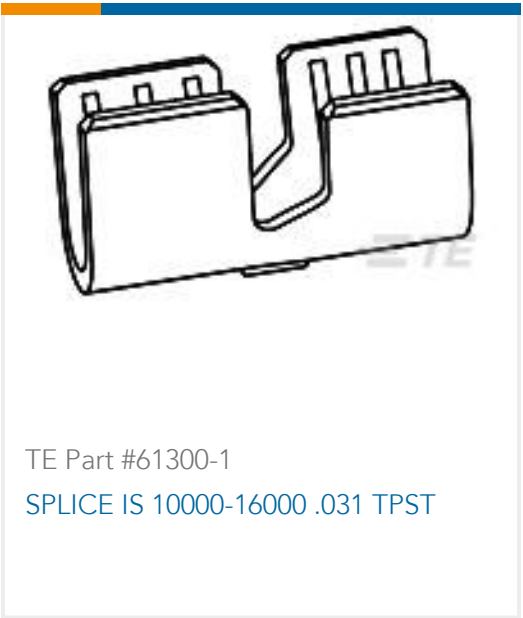



TE Part #063725P017  
ES2000-NO.2-B9-0-40MM

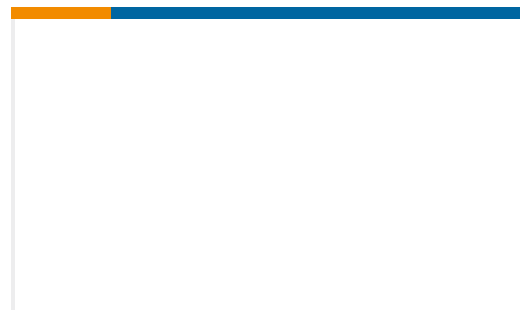

TE Part #5-1897638-5  
C.E BOX ASSY-BLM F/L-1FAN,4PW,  
STD

## Documents

### Product Drawings

[250 FASTON,REC.,20-14 AWG,BR](#)

English

### CAD Files

[3D PDF](#)

3D

Customer View Model

[ENG\\_CVM\\_CVM\\_170032-1\\_AS.2d\\_dxf.zip](#)

English

Customer View Model

[ENG\\_CVM\\_CVM\\_170032-1\\_AS.3d\\_igs.zip](#)

English

Customer View Model

[ENG\\_CVM\\_CVM\\_170032-1\\_AS.3d\\_stp.zip](#)

English

By downloading the CAD file I accept and agree to the [Terms and Conditions](#) of use.

### Product Specifications

[Crimping of 250 Series Tab and Receptacle Contacts](#)

Japanese

[Application Specification](#)

Japanese

[Application Specification](#)

Japanese

[Crimping of 250 Series Tab and Receptacle Contacts](#)

Japanese

### Product Environmental Compliance

[Product Compliance](#)

English

[Product Compliance](#)

English