

165046 ✓ ACTIVE



PIDG

TE Internal #: 165046

Crimp Wire Pins, Tabs & Ferrules, Wire Pin, Mating Pin Diameter

1.78 mm [.07 in], 16 – 14 AWG Wire Size, 1 – 2.6 mm² Wire Size,

PIDG

[View on TE.com >](#)

Terminals & Splices > Crimp Wire Pins, Tabs & Ferrules > PIDG Formed Wire Pins

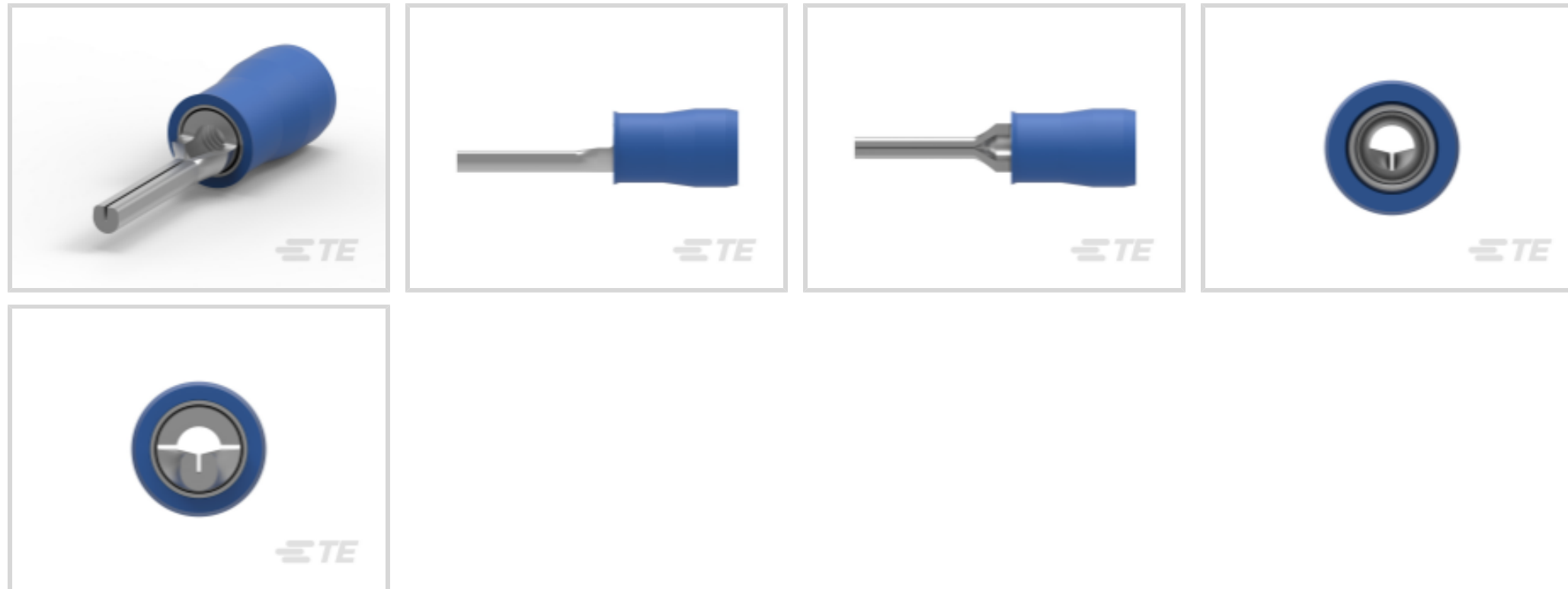

Crimp Wire Terminal Type: **Wire Pin**

Mating Pin Diameter: **1.78 mm [.07 in]**

Compatible Insulation Diameter Range: **2.92 – 4.31 mm, 4.3 mm [.115 – .17 in, .17 in]**

Wire Size: **1 – 2.6 mm²**

[All PIDG Formed Wire Pins \(6\)](#)

Features

Product Type Features

Sealable	No
Compatible With Discrete Wire Type	Stranded
Wire Insulation Support Retention Type	Insulation Support

Configuration Features

Compatible With Wire & Cable Type	Discrete Wire
-----------------------------------	---------------

Body Features

Sleeve Material	Nylon
Insulation Material	Nylon
Primary Product Color	Blue

Contact Features

Contact Mating Area Length	6.7 mm[.26 in]
Contact Fabrication	Stamped & Formed
Crimp Wire Terminal Type	Wire Pin



Mating Pin Diameter	1.78 mm [.07 in]
---------------------	------------------

Barrel Type	Closed
-------------	--------

Terminal Plating Material	Tin
---------------------------	-----

Contact Shape & Form	Round
----------------------	-------

Terminal Orientation	Straight
----------------------	----------

Mechanical Attachment

Wire Insulation Support	With
-------------------------	------

Dimensions

DIN Wire Size	1 – 2.5 mm ²
---------------	-------------------------

Compatible Insulation Diameter Range	2.92 – 4.31 mm, 4.3 mm [.115 – .17 in] [.17 in]
--------------------------------------	---

Wire Size	2050 – 5180 CMA
-----------	-----------------

Barrel Inside Diameter	4.3 mm [.169 in]
------------------------	------------------

Terminal Material Thickness	.79 mm [.031 in]
-----------------------------	------------------

Overall Product Length	19.69 mm [.775 in]
------------------------	--------------------

Usage Conditions

Insulation Option	Partially Insulated
-------------------	---------------------

Operating Temperature Range	105 °C [221 °F]
-----------------------------	-----------------

Packaging Features

Packaging Quantity	1000
--------------------	------

Packaging Method	Loose Piece
------------------	-------------

Product Compliance

[For compliance documentation, visit the product page on TE.com>](#)

EU RoHS Directive 2011/65/EU	Compliant
------------------------------	-----------

EU ELV Directive 2000/53/EC	Compliant
-----------------------------	-----------

China RoHS 2 Directive MIIT Order No 32, 2016	No Restricted Materials Above Threshold
---	---

EU REACH Regulation (EC) No. 1907/2006	Current ECHA Candidate List: JUNE 2023 (235) Candidate List Declared Against: JUNE 2023 (235) Does not contain REACH SVHC
--	---













Halogen Content	Low Halogen - Br, Cl, F, I < 900 ppm per homogenous material. Also BFR/CFR/PVC Free
-----------------	---

Solder Process Capability	Not applicable for solder process capability
---------------------------	--

Product Compliance Disclaimer

This information is provided based on reasonable inquiry of our suppliers and represents our current actual knowledge based on the information they provided. This information is subject to change. The part numbers that TE has identified as EU RoHS compliant have a maximum concentration of 0.1% by weight in homogenous materials for lead, hexavalent chromium, mercury, PBB, PBDE, DBP, BBP, DEHP, DIBP, and 0.01% for cadmium, or qualify for an exemption to these limits as defined in the Annexes of Directive 2011/65/EU (RoHS2). Finished electrical and electronic equipment products will be CE marked as required by Directive 2011/65/EU. Components may not be CE marked. Additionally, the part numbers that TE has identified as EU ELV compliant have a maximum concentration of 0.1% by weight in homogenous materials for lead, hexavalent chromium, and mercury, and 0.01% for cadmium, or qualify for an exemption to these limits as defined in the Annexes of Directive 2000/53/EC (ELV). Regarding the REACH Regulation, the information TE provides on SVHC in articles for this part number is based on the latest European Chemicals Agency (ECHA) 'Guidance on requirements for substances in articles' posted at this URL: <https://echa.europa.eu/guidance-documents/guidance-on-reach>

Compatible Parts

 <p>TE Part # 59824-1 TETRA-CRIMP PIDG PG FASTON 22-10 ASSY</p>	 <p>TE Part # 47387 DAHT PG PIDG 20-14 ASSY</p>	 <p>TE Part # 58423-1 DIE, RBY IS9252</p>	 <p>TE Part # 47387-7 DAHT PG PIDG 16-12 ASSY</p>
 <p>TE Part # 696394-2 TERM, WIRE PIN, PIDG, 16-14, T&R</p>	 <p>TE Part # 58433-3 PRO CR ASSY, RBY IS9252</p>	 <p>TE Part # 525691 DAHT PG PIDG 16-14 ASSY</p>	 <p>TE Part # 539691-2 ERGO DIE R.B.Y</p>
 <p>TE Part # 1-1377174-3 SMP 0-0165046-0</p>	 <p>TE Part # 2063030-1 SDE DIESET, RBY, UL</p>	 <p>TE Part # 169400 CERTI-LOK FRAME W/O DIES</p>	 <p>TE Part # 1SET191001R0000 CRIMP-HT</p>

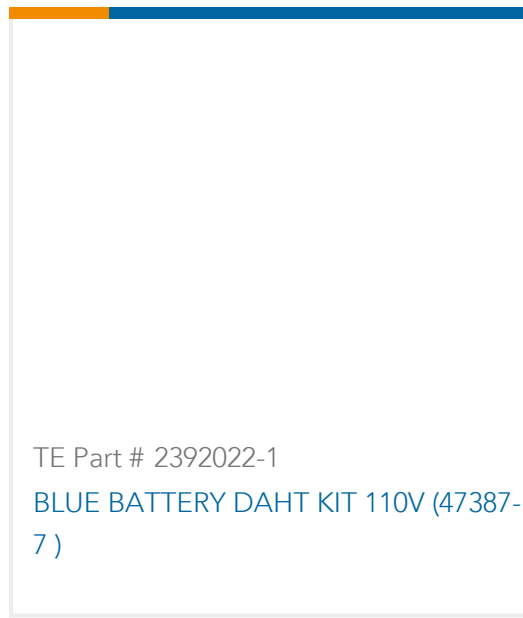

Also in the Series | PIDG

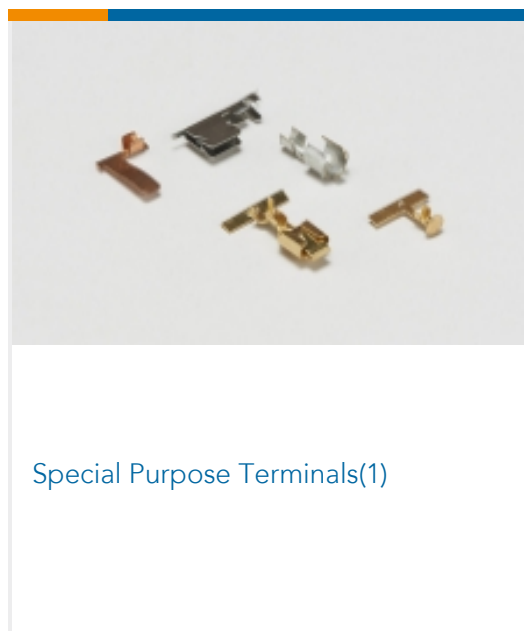
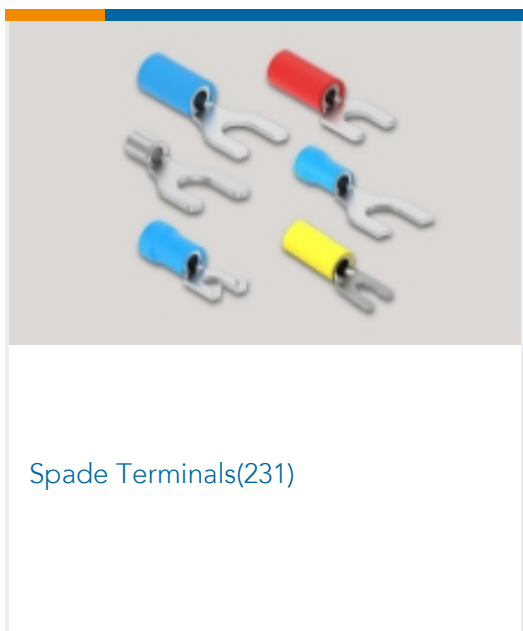
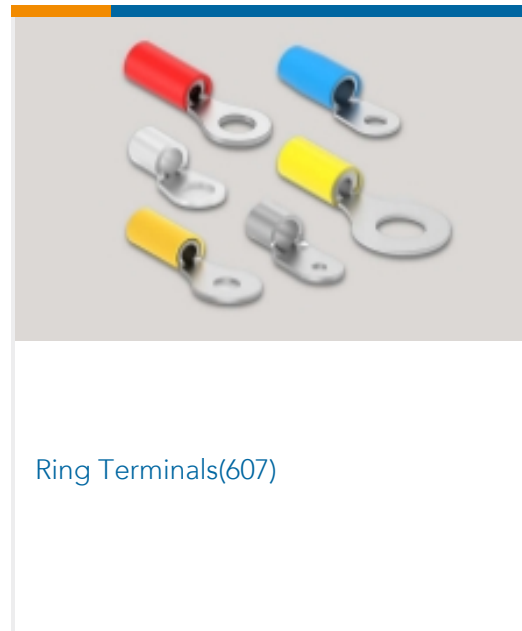
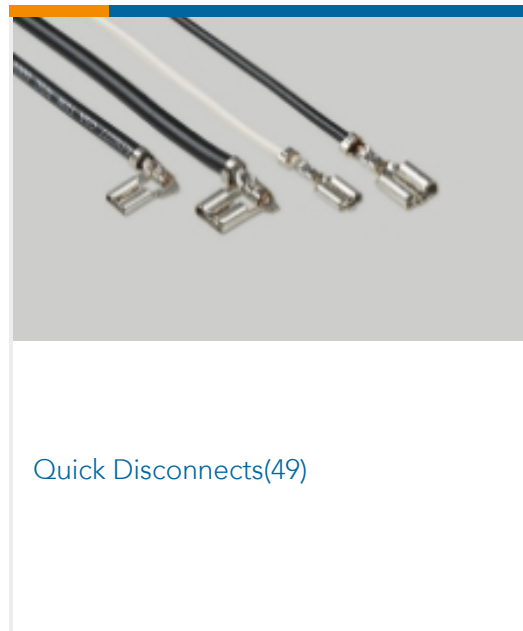
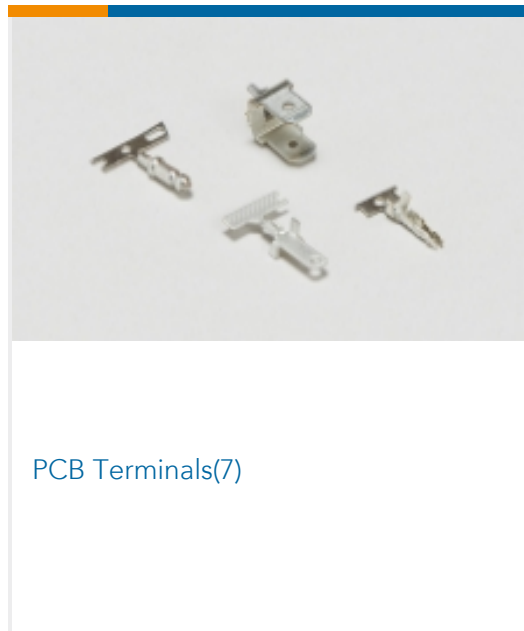
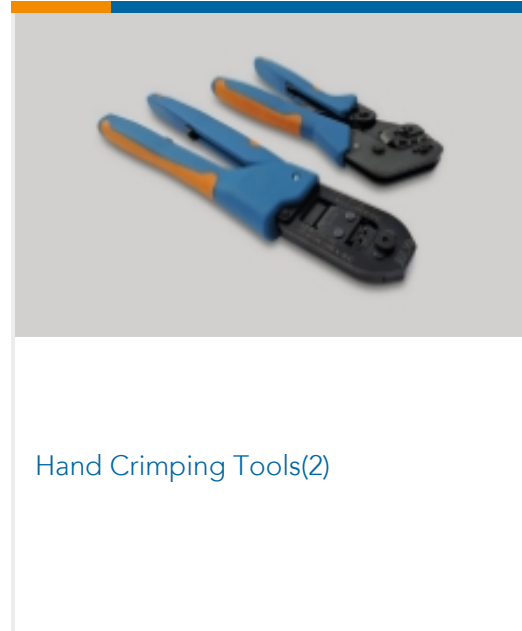
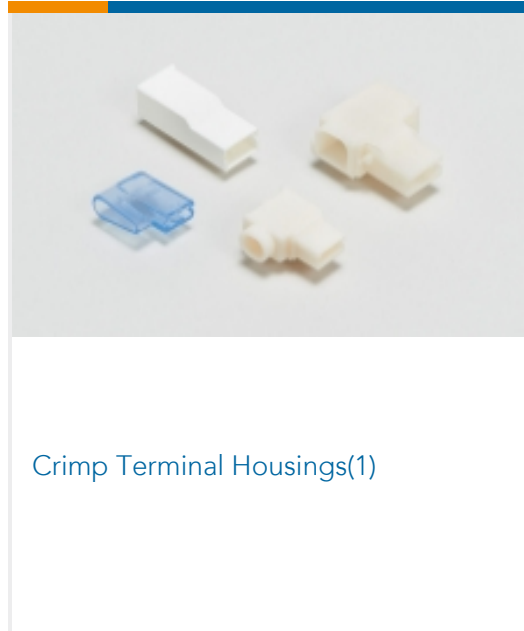
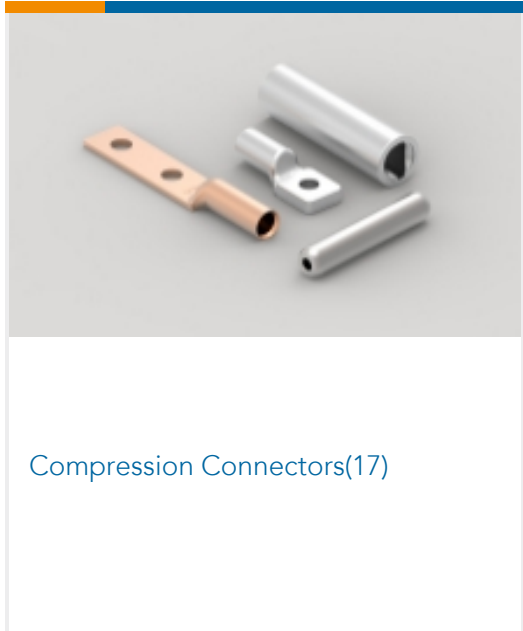

Customers Also Bought

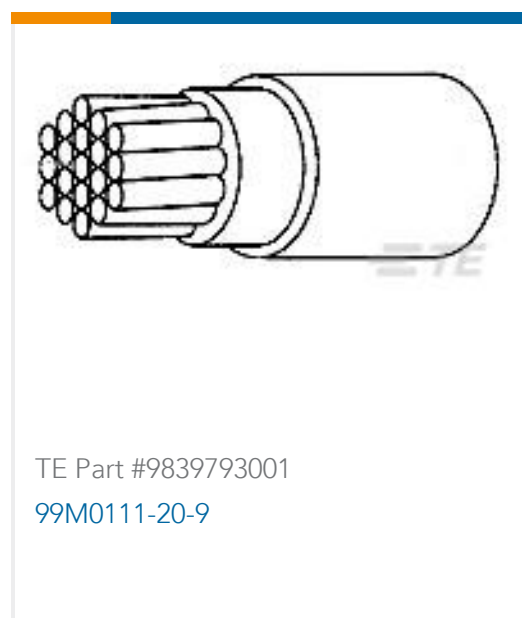
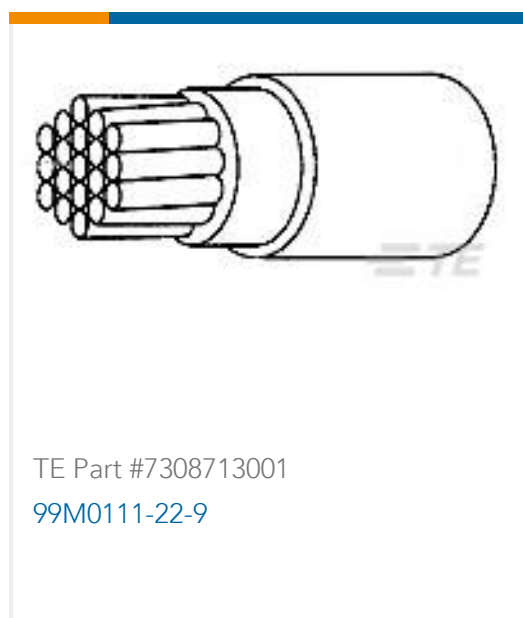

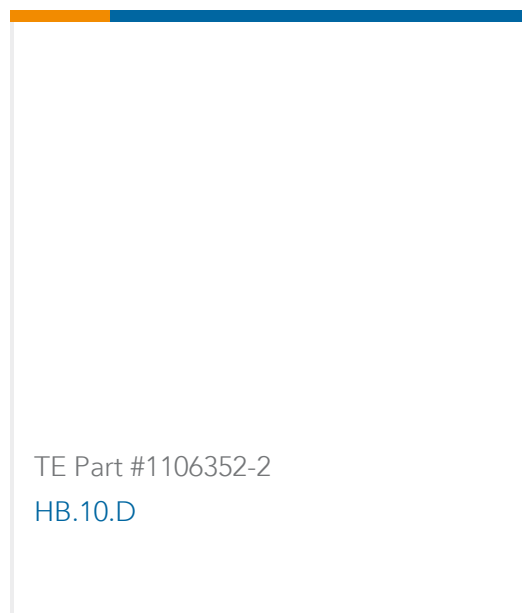

Documents

Product Drawings

PIDG WIRE PIN

English

CAD Files

3D PDF

3D

Customer View Model

[ENG_CVM_CVM_165046_N.2d_dxf.zip](#)

English

Customer View Model

[ENG_CVM_CVM_165046_N.3d_igs.zip](#)

English

Customer View Model

[ENG_CVM_CVM_165046_N.3d_stp.zip](#)

English

3D PDF

English

Customer View Model

[ENG_CVM_165046_G.3d_igs.zip](#)

English

Customer View Model

[ENG_CVM_165046_G.3d_stp.zip](#)

English

Customer View Model

[ENG_CVM_165046_G.2d_dxf.zip](#)

English



By downloading the CAD file I accept and agree to the [Terms and Conditions](#) of use.

Datasheets & Catalog Pages

PIDG TERMINALS & SPLICES Quick Reference Guide

English

Product Specifications

Application Specification

English

Product Environmental Compliance

TE Material Declaration

English

Instruction Sheets

Instruction Sheet (U.S.)

English

Agency Approvals

UL Report

English