

165035 ✓ ACTIVE

PLASTI-GRIP

TE Internal #: 165035

Closed Ring Tongue Terminal, 12 – 10 AWG, M6 Stud Size, 6.73 mm [.265 in] Stud Diameter, Closed Barrel, Straight, Tin, PLASTI-GRIP

[View on TE.com >](#)



Terminals & Splices > Ring Terminals

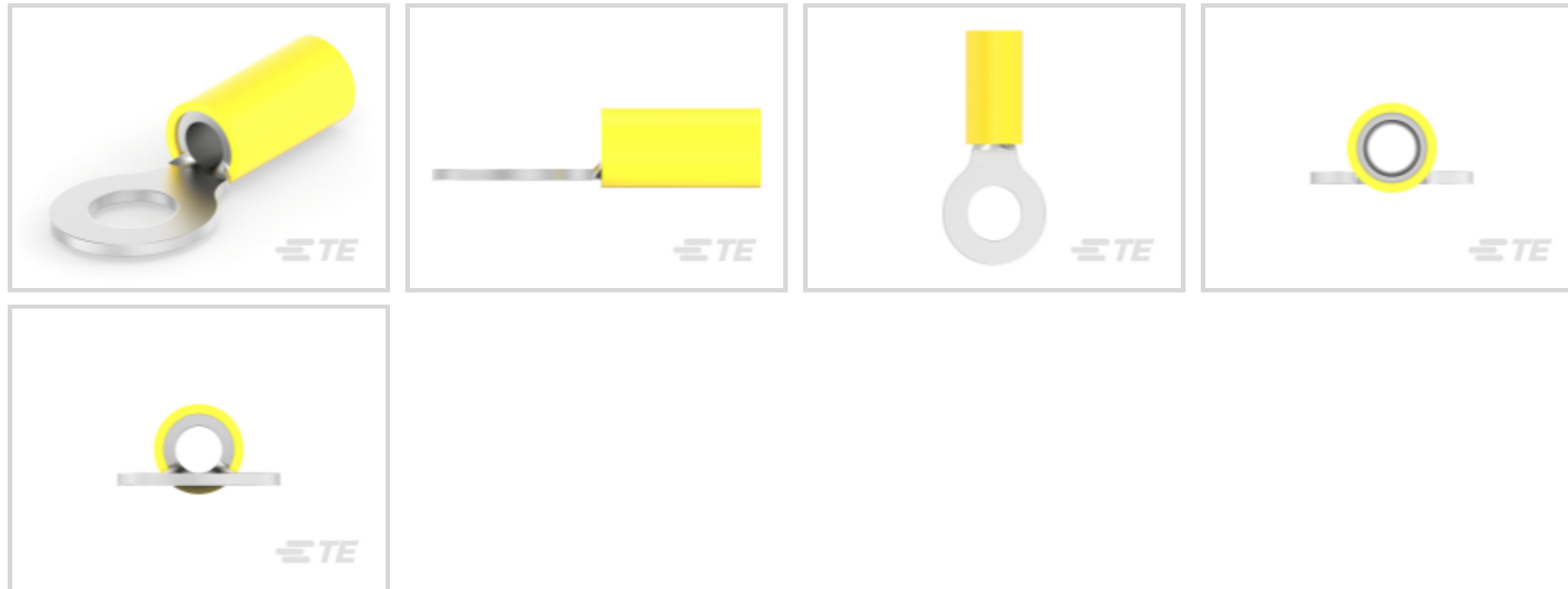

Ring Terminal Product Type: Closed Ring Tongue Terminal

Wire Size: 5180 – 13100 CMA

Stud Size: M6

Features

Product Type Features

Ring Terminal Product Type	Closed Ring Tongue Terminal
Stud Size	M6
Sealable	No
Wire Insulation Support Retention Type	Insulation Support

Configuration Features

Number of Holes	1
-----------------	---

Electrical Characteristics

Voltage Rating	600 V
----------------	-------

Body Features

Product Weight	5.311 g
Insulation Sleeve Color	Yellow
Stripe Color	Yellow

Contact Features

Barrel Type	Closed
Terminal Orientation	Straight



Terminal Plating Material	Tin
---------------------------	-----

Mechanical Attachment

Wire Insulation Support	Without
-------------------------	---------

Dimensions

Wire Size	5180 – 13100 CMA
Stud Diameter	6.73 mm [.265 in]
Tongue Thickness	.79 mm [.031 in]
Product Length	30.07 mm [1.184 in]
Compatible Insulation Diameter (Max)	6.78 mm [.267 in]
Compatible Insulation Diameter Range	6.4 – 6.78 mm [.252 – .267 in]

Usage Conditions

Insulation Option	Partially Insulated
Operating Temperature Range	105 °C [221 °F]

Operation/Application

Compatible With Wire Base Material	Copper
Compatible With Wire Plating Material	Tin

Industry Standards

Government Qualified Terminal	No
-------------------------------	----

Packaging Features

Packaging Quantity	500
Packaging Method	Loose Piece

Product Compliance

[For compliance documentation, visit the product page on TE.com>](#)

EU RoHS Directive 2011/65/EU	Compliant
EU ELV Directive 2000/53/EC	Compliant
China RoHS 2 Directive MIIT Order No 32, 2016	No Restricted Materials Above Threshold
EU REACH Regulation (EC) No. 1907/2006	Current ECHA Candidate List: JUNE 2023 (235) Candidate List Declared Against: JUNE 2023 (235) Does not contain REACH SVHC
Halogen Content	Not Low Halogen - contains Br or Cl > 900 ppm.









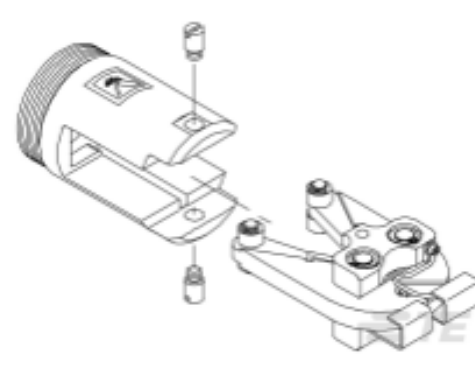

Solder Process Capability

Not applicable for solder process capability

Product Compliance Disclaimer

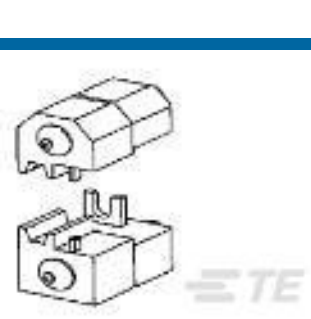
This information is provided based on reasonable inquiry of our suppliers and represents our current actual knowledge based on the information they provided. This information is subject to change. The part numbers that TE has identified as EU RoHS compliant have a maximum concentration of 0.1% by weight in homogenous materials for lead, hexavalent chromium, mercury, PBB, PBDE, DBP, BBP, DEHP, DIBP, and 0.01% for cadmium, or qualify for an exemption to these limits as defined in the Annexes of Directive 2011/65/EU (RoHS2). Finished electrical and electronic equipment products will be CE marked as required by Directive 2011/65/EU. Components may not be CE marked. Additionally, the part numbers that TE has identified as EU ELV compliant have a maximum concentration of 0.1% by weight in homogenous materials for lead, hexavalent chromium, and mercury, and 0.01% for cadmium, or qualify for an exemption to these limits as defined in the Annexes of Directive 2000/53/EC (ELV). Regarding the REACH Regulation, the information TE provides on SVHC in articles for this part number is based on the latest European Chemicals Agency (ECHA) 'Guidance on requirements for substances in articles' posted at this URL: <https://echa.europa.eu/guidance-documents/guidance-on-reach>

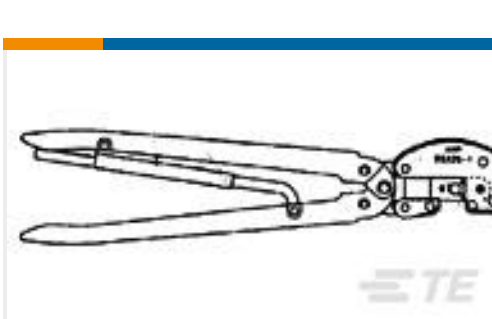
Compatible Parts

 <p>TE Part # 59824-1 TETRA-CRIMP PIDG PG FASTON 22-10 ASSY</p>	 <p>TE Part # 59239-4 HHHT PIDG PG 12-10 ASSY</p>	 <p>TE Part # 58423-1 DIE, RBY IS9252</p>	 <p>TE Part # 679300-1 1210 PIDG CRIMP HEAD</p>
 <p>TE Part # 58433-3 PRO CR ASSY, RBY IS9252</p>	 <p>TE Part # 539691-2 ERGO DIE R.B.Y</p>	 <p>TE Part # 5-1377175-4 SMP 0-0165035-0</p>	 <p>TE Part # 2063030-1 SDE DIESET, RBY, UL</p>
 <p>TE Part # 47808-6 DIES PIDG 12-10 DIE SET</p>	 <p>TE Part # 169400 CERTI-LOK FRAME W/O DIES</p>	 <p>TE Part # 1-59239-4 HHHT PIDG 16-10 HEAD</p>	 <p>TE Part # 1SET191001R0000 CRIMP-HT</p>



Also in the Series | PLASTI-GRIP

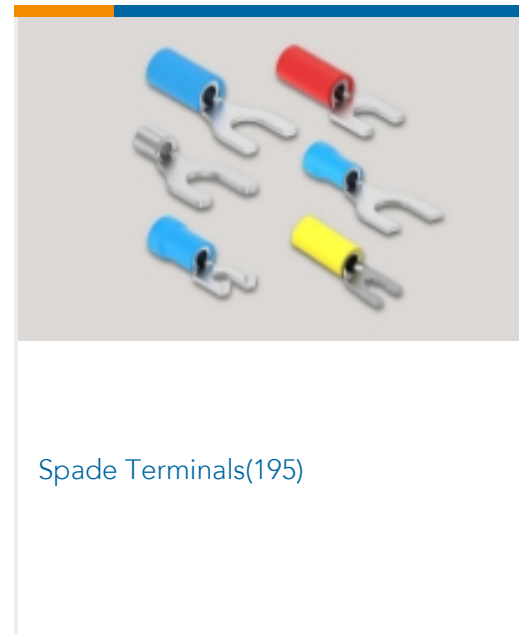
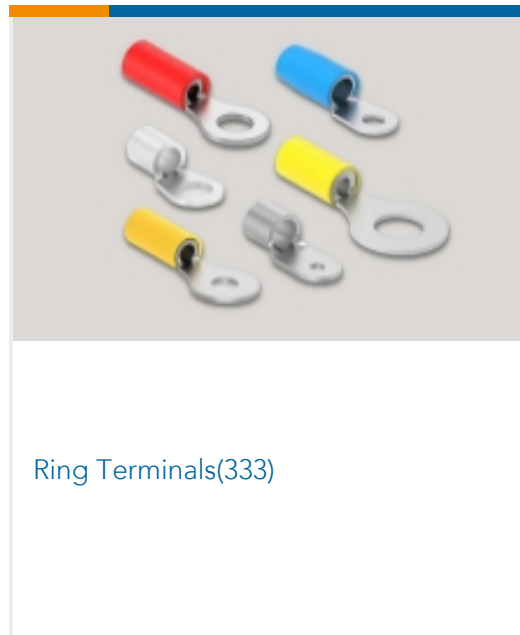
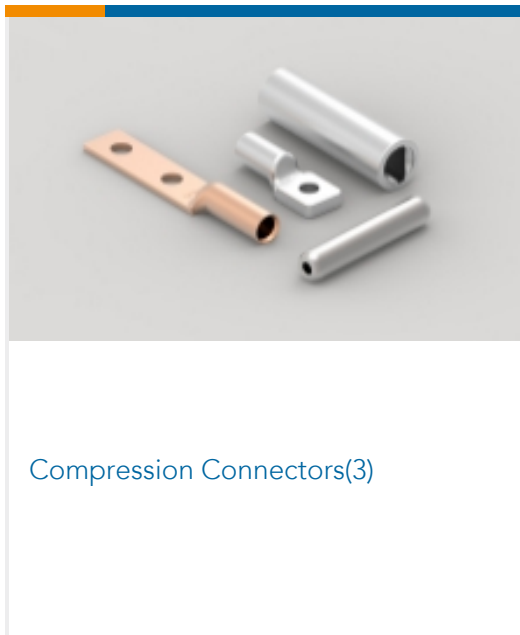

Customers Also Bought

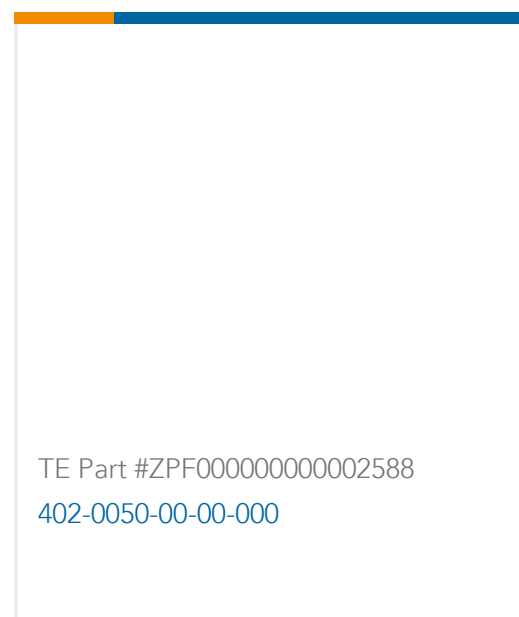
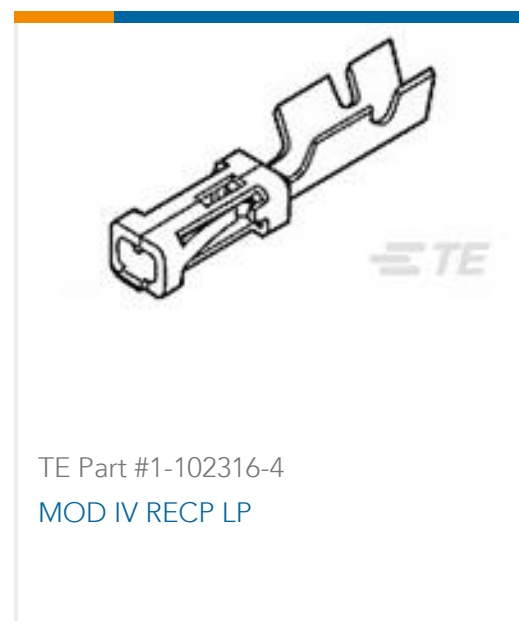
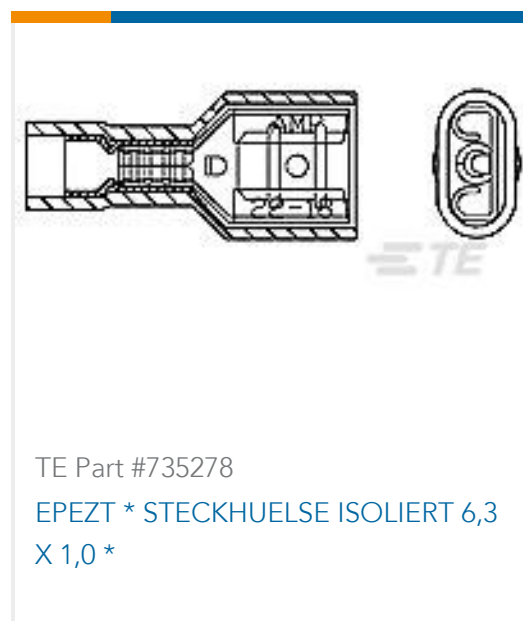
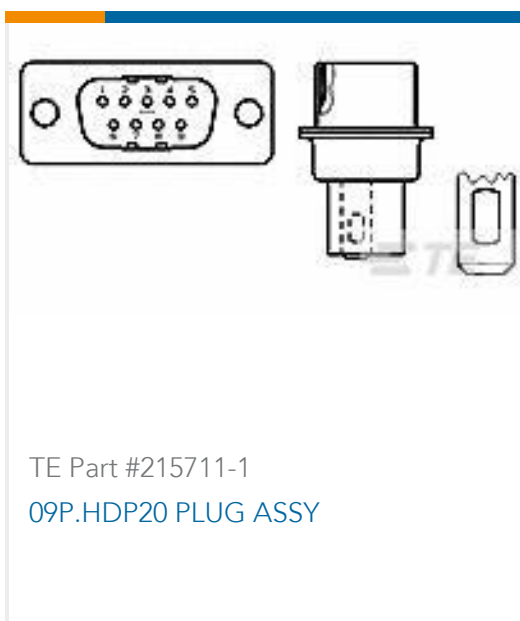



Documents

Product Drawings

[PLASTI-GRIP, RING, 12-10 1/4](#)

English

CAD Files

3D PDF

3D

Customer View Model

[ENG_CVM_CVM_165035_M.2d_dxf.zip](#)

English

Customer View Model

[ENG_CVM_CVM_165035_M.3d_igs.zip](#)

English

Customer View Model

[ENG_CVM_CVM_165035_M.3d_stp.zip](#)

English

3D PDF

English

Customer View Model

[ENG_CVM_165035_A.3d_igs.zip](#)

English

Customer View Model

[ENG_CVM_165035_A.3d_stp.zip](#)

English

Customer View Model

[ENG_CVM_165035_A.2d_dxf.zip](#)

English

By downloading the CAD file I accept and agree to the [Terms and Conditions](#) of use.

Product Specifications

[Application Specification](#)

English

Product Environmental Compliance

[TE Material Declaration](#)

English



Instruction Sheets

[Instruction Sheet \(U.S.\)](#)

English

Agency Approvals

[UL Report](#)

English

[UL Report](#)

English