

1586359-4 ✓ ACTIVE

MATE-N-LOK | Mini-Universal MATE-N-LOK

TE Internal #: 1586359-4

Gang Wire Seal, Silicone Rubber, Blue, .05 – .083 in [1.27 – 2.11 mm] Insulation Diameter, Mini-Universal MATE-N-LOK

[View on TE.com >](#)



Connectors > Connector Accessories > Connector Seals & Cavity Plugs



Connector Seal & Plug Type: **Gang Wire Seal**

Primary Product Material: **Silicone Rubber**

Primary Product Color: **Blue**

Compatible Insulation Diameter Range: **1.27 – 2.11 mm [.05 – .083 in]**

Operating Temperature (Max): **90 °C [194 °F]**

Features

Product Type Features

Connector Seal & Plug Type	Gang Wire Seal
----------------------------	----------------

Body Features

Primary Product Material	Silicone Rubber
Primary Product Color	Blue

Dimensions

Wire Size	.12 – .8 mm ²
Compatible Insulation Diameter Range	1.27 – 2.11 mm [.05 – .083 in]

Usage Conditions

Operating Temperature (Max)	90 °C [194 °F]
Operating Temperature Range	-40 – 90 °C [-40 – 194 °F]

Packaging Features

Packaging Quantity	1600
Packaging Method	Bag



Product Compliance

[For compliance documentation, visit the product page on TE.com>](#)

EU RoHS Directive 2011/65/EU	Compliant
EU ELV Directive 2000/53/EC	Compliant
China RoHS 2 Directive MIIT Order No 32, 2016	No Restricted Materials Above Threshold
EU REACH Regulation (EC) No. 1907/2006	Current ECHA Candidate List: JUNE 2023 (235) Candidate List Declared Against: JAN 2021 (211) Does not contain REACH SVHC
Halogen Content	Low Halogen - Br, Cl, F, I < 900 ppm per homogenous material. Also BFR/CFR/PVC Free
Solder Process Capability	Not applicable for solder process capability

Product Compliance Disclaimer

This information is provided based on reasonable inquiry of our suppliers and represents our current actual knowledge based on the information they provided. This information is subject to change. The part numbers that TE has identified as EU RoHS compliant have a maximum concentration of 0.1% by weight in homogenous materials for lead, hexavalent chromium, mercury, PBB, PBDE, DBP, BBP, DEHP, DIBP, and 0.01% for cadmium, or qualify for an exemption to these limits as defined in the Annexes of Directive 2011/65/EU (RoHS2). Finished electrical and electronic equipment products will be CE marked as required by Directive 2011/65/EU. Components may not be CE marked. Additionally, the part numbers that TE has identified as EU ELV compliant have a maximum concentration of 0.1% by weight in homogenous materials for lead, hexavalent chromium, and mercury, and 0.01% for cadmium, or qualify for an exemption to these limits as defined in the Annexes of Directive 2000/53/EC (ELV). Regarding the REACH Regulation, the information TE provides on SVHC in articles for this part number is based on the latest European Chemicals Agency (ECHA) 'Guidance on requirements for substances in articles' posted at this URL: <https://echa.europa.eu/guidance-documents/guidance-on-reach>

Compatible Parts

 <p>TE Part # 794805-1 4 CIR UMNL PLUG, ROUND HOLES</p>	 <p>TE Part # 794772-4 04P MINI UMNL SEAL, DIE CUT</p>	 <p>TE Part # 794758-1 MINI UMNL WIRE SEAL, 18-26AWG</p>	 <p>TE Part # 794939-1 04P MINI UMNL CAP HSG</p>
--	--	---	---

Also in the Series | [Mini-Universal MATE-N-LOK](#)

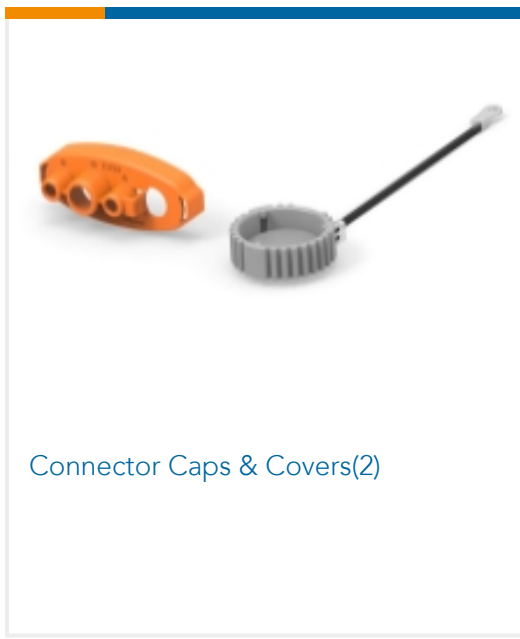

Connector Caps & Covers(2)

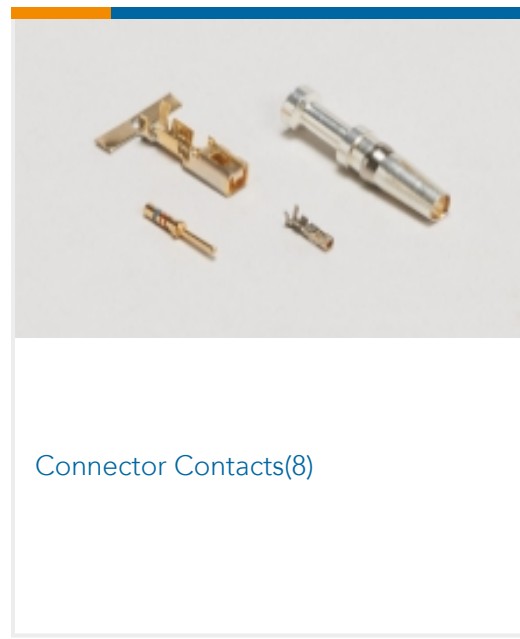

Connector Contacts(8)

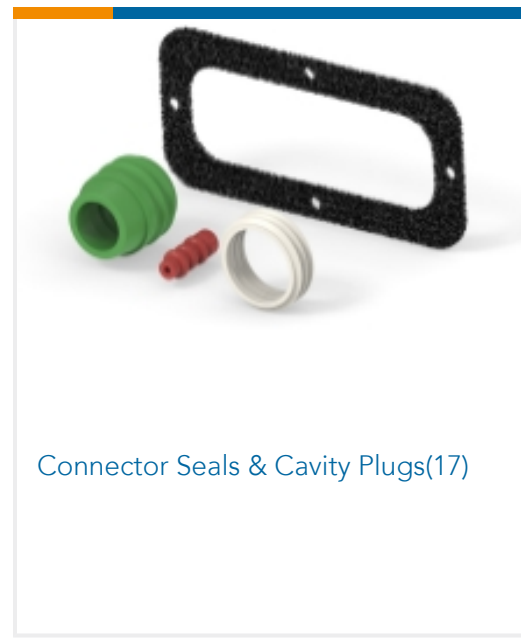

Connector Seals & Cavity Plugs(17)

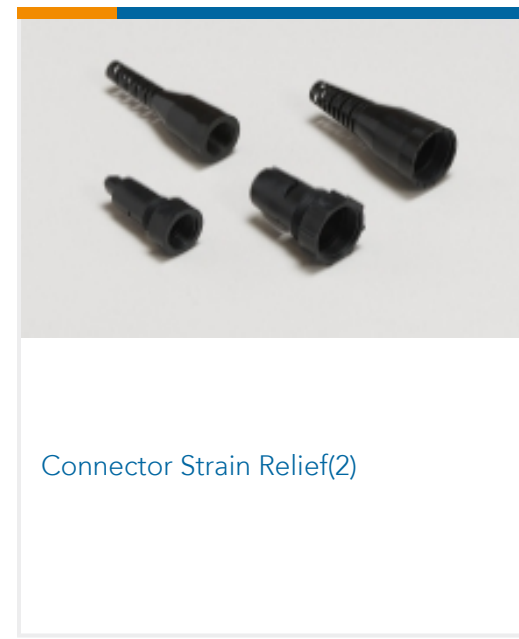

Connector Strain Relief(2)

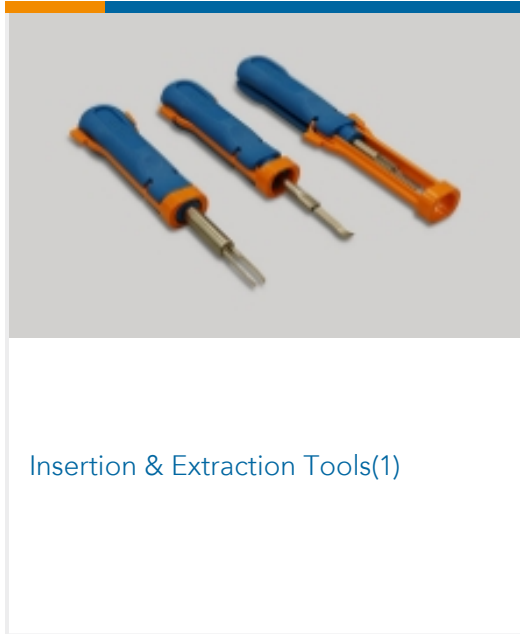

Insertion & Extraction Tools(1)



PCB Headers & Receptacles(1)

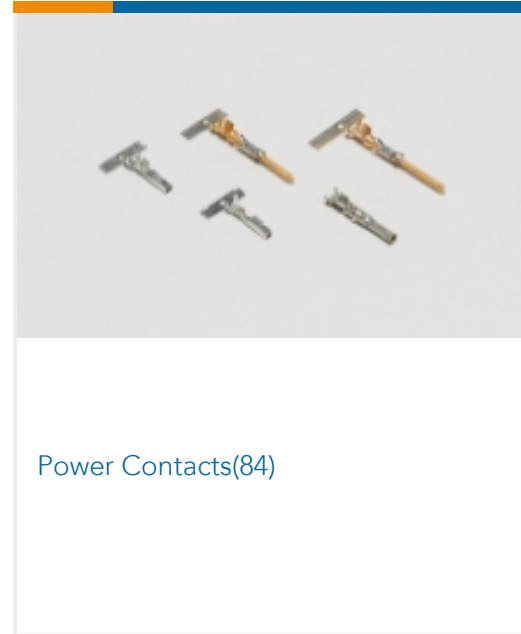

Power Contacts(84)

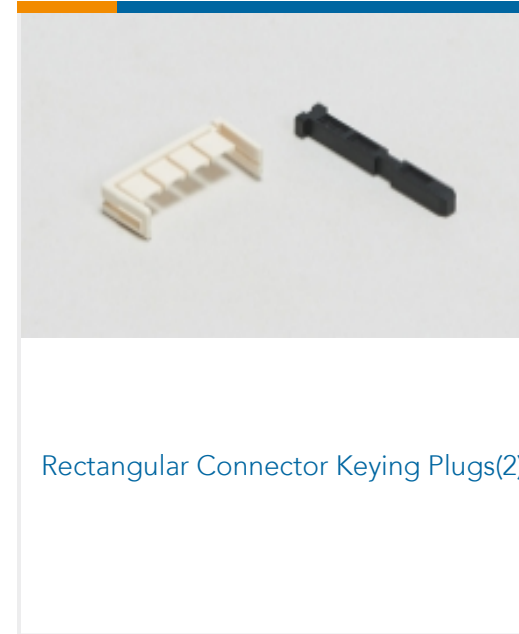

Rectangular Connector Keying Plugs(2)

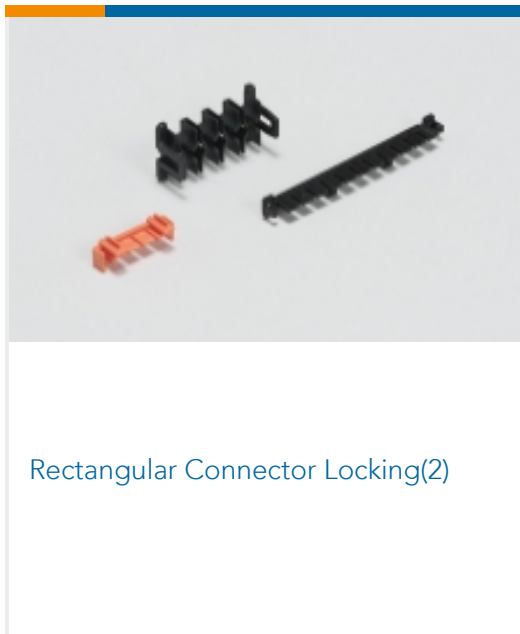

Rectangular Connector Locking(2)



Rectangular Power Connectors(244)

Customers Also Bought



TE Part #794940-1
06P MINI UMNL CAP HSG



TE Part #172344-1
MINI UNIVERSAL MATE-N-LOK CAP HOUSING 3P



TE Part #1-770874-0
04P MINI UMNL HDR ASSY SN LF



TE Part #794772-4
04P MINI UMNL SEAL,DIE CUT

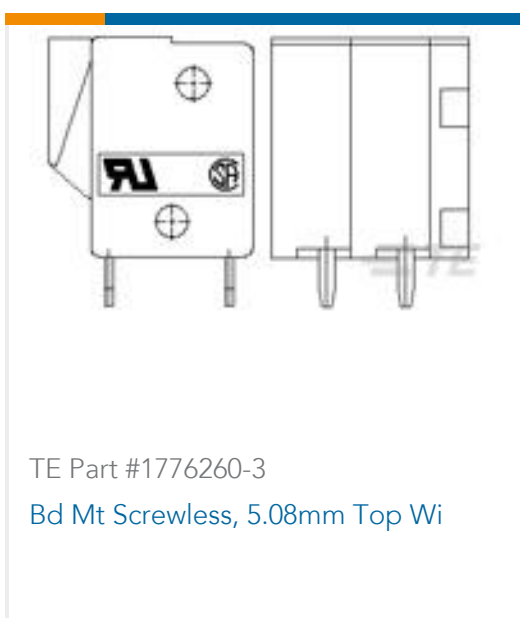

TE Part #1776260-3
Bd Mt Screwless, 5.08mm Top Wi



TE Part #205841-2
CPC RECPT ASSEMBLY SIZE 11-8



TE Part #1-1586359-0
10P MINIMUMNL GANG WIRE SEAL DR



TE Part #151680
2 WAY MATE-N-LOK SOC HSG NAT.



Documents

Product Drawings

[04P MINIUMNL GANG WIRE SEAL DR](#)

English

CAD Files

Customer View Model

[ENG_CVM_CVM_1586359-4_D.2d_dxf.zip](#)

English

[3D PDF](#)

3D

Customer View Model

[ENG_CVM_CVM_1586359-4_D.3d_igs.zip](#)

English

Customer View Model

[ENG_CVM_CVM_1586359-4_D.3d_stp.zip](#)

English

By downloading the CAD file I accept and agree to the [Terms and Conditions](#) of use.

Datasheets & Catalog Pages

[SOFT_SHELL_PIN_AND_SOCKET_CONNECTORS_CATALOG](#)

English

Product Specifications

[Application Specification](#)

English

Product Environmental Compliance

[Safety Datasheet](#)

English

Instruction Sheets

[Instruction Sheet \(U.S.\)](#)

English