

1577647-1 ✓ ACTIVE



STRATO-THERM

TE Internal #: 1577647-1

Closed Ring Tongue Terminal, 10 AWG, #10 Stud Size, 5 mm [.197 in] Stud Diameter, Closed Barrel, Straight, Nickel, Partially Insulated, STRATO-THERM

[View on TE.com >](#)

Terminals & Splices > Ring Terminals

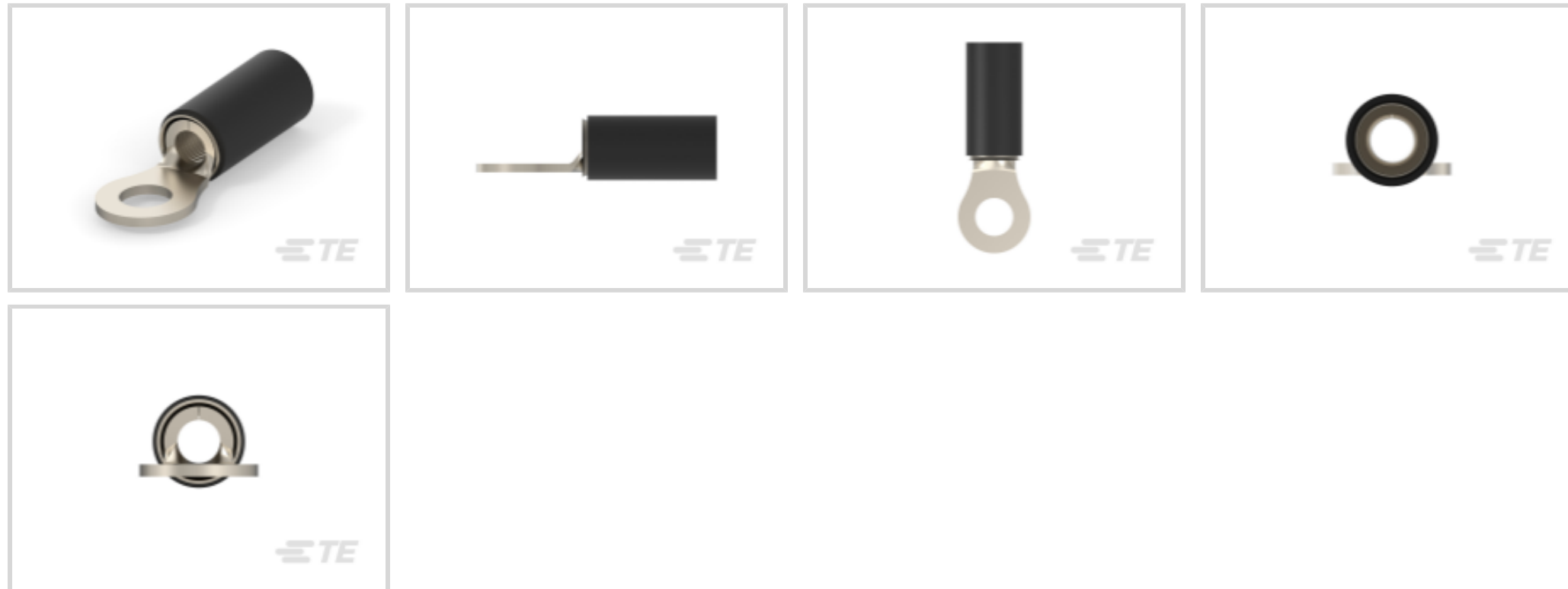

Ring Terminal Product Type: **Closed Ring Tongue Terminal**

Wire Size: **12066 CMA**

Stud Size: **#10**

Features

Product Type Features

Ring Terminal Product Type	Closed Ring Tongue Terminal
Stud Size	#10
Sealable	No
Wire Insulation Support Retention Type	Insulation Support

Configuration Features

Number of Holes	1
-----------------	---

Electrical Characteristics

Current Rating	1 A
----------------	-----

Body Features

Insulation Sleeve Color	Black
Stripe Color	Black

Contact Features

Barrel Type	Closed
Terminal Orientation	Straight
Terminal Plating Material	Nickel



Mechanical Attachment

Wire Insulation Support	With
-------------------------	------

Dimensions

Compatible Insulation Diameter (Min)	2.6 mm[.102 in]
Wire Size	12066 CMA
Stud Diameter	5 mm[.197 in]
Tongue Thickness	.79 mm[.031 in]
Product Length	28.43 mm[1.119 in]
Compatible Insulation Diameter (Max)	5.44 mm[.214 in]
Compatible Insulation Diameter Range	2.59 – 5.44 mm[.102 – .214 in]

Usage Conditions

Insulation Option	Partially Insulated
Operating Temperature Range	260 °C[500 °F]

Industry Standards

Government Qualified Terminal	No
-------------------------------	----

Packaging Features

Packaging Quantity	250
Packaging Method	Bag

Product Compliance

[For compliance documentation, visit the product page on TE.com>](#)

EU RoHS Directive 2011/65/EU	Compliant
EU ELV Directive 2000/53/EC	Compliant
China RoHS 2 Directive MIIT Order No 32, 2016	No Restricted Materials Above Threshold
EU REACH Regulation (EC) No. 1907/2006	Current ECHA Candidate List: JUNE 2023 (235) Candidate List Declared Against: JUNE 2022 (224) Does not contain REACH SVHC
Halogen Content	Low Halogen - Br, Cl, F, I < 900 ppm per homogenous material. Also BFR/CFR/PVC Free
Solder Process Capability	Not applicable for solder process capability

Product Compliance Disclaimer



This information is provided based on reasonable inquiry of our suppliers and represents our current actual knowledge based on the information they provided. This information is subject to change. The part numbers that TE has identified as EU RoHS compliant have a maximum concentration of 0.1% by weight in homogenous materials for lead, hexavalent chromium, mercury, PBB, PBDE, DBP, BBP, DEHP, DIBP, and 0.01% for cadmium, or qualify for an exemption to these limits as defined in the Annexes of Directive 2011/65/EU (RoHS2). Finished electrical and electronic equipment products will be CE marked as required by Directive 2011/65/EU. Components may not be CE marked. Additionally, the part numbers that TE has identified as EU ELV compliant have a maximum concentration of 0.1% by weight in homogenous materials for lead, hexavalent chromium, and mercury, and 0.01% for cadmium, or qualify for an exemption to these limits as defined in the Annexes of Directive 2000/53/EC (ELV). Regarding the REACH Regulation, the information TE provides on SVHC in articles for this part number is based on the latest European Chemicals Agency (ECHA) 'Guidance on requirements for substances in articles' posted at this URL: <https://echa.europa.eu/guidance-documents/guidance-on-reach>

Compatible Parts



TE Part # 576784
HHHT PIDG PEEK STRATO 10 ASSY



TE Part # 576723
SAHT PIDG PEEK STRATO 10 DIE SET



TE Part # 2-1577647-2
TERMINAL RT PIDG PEEK STRATO 10AWG REEL

Also in the Series | STRATO-THERM



Crimp Wire Pins, Tabs & Ferrules(1)

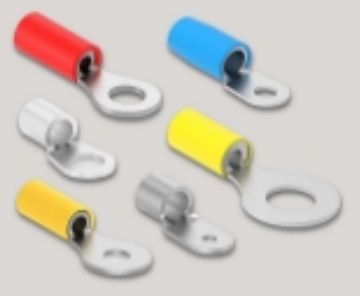

Ring Terminals(93)



Splices(16)

Customers Also Bought



TE Part #1577618-1
TERMINAL RT PIDG PEEK STRATO 24-22 AWG



TE Part #1577625-1
TERMINAL RT PIDG PEEK STRATO 20 AWG

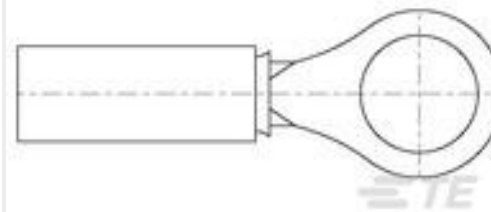

TE Part #1577624-1
TERMINAL RT PIDG PEEK STRATO 20 AWG



TE Part #1577640-1
TERMINAL RT PIDG PEEK STRATO 14-12 AWG



TE Part #ZPF000000000020170
FMJ 12E 22-02



TE Part #121444-000
TTMS-25.4-4

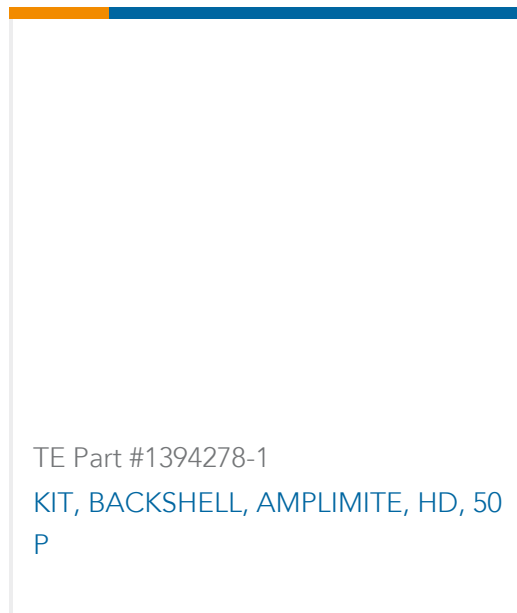

TE Part #1394278-1
KIT, BACKSHELL, AMPLIMITE, HD, 50 P

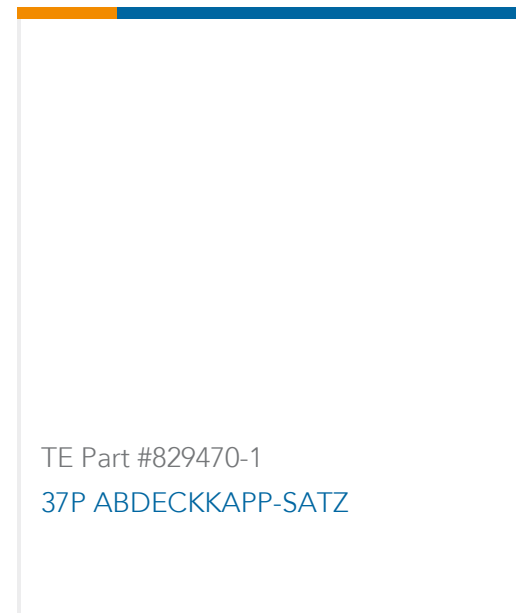

TE Part #829470-1
37P ABDECKKAPP-SATZ

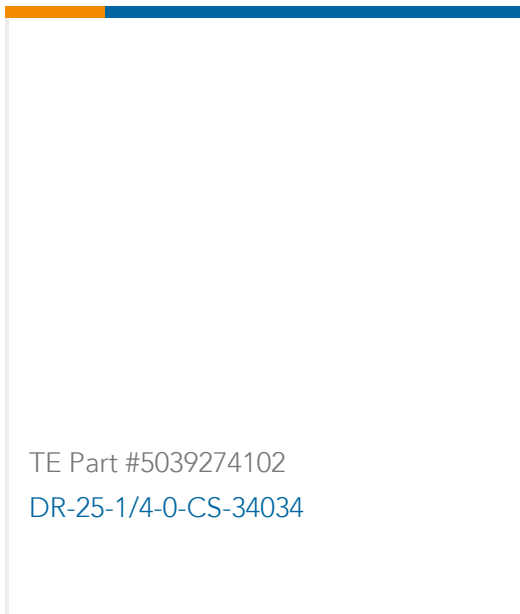

TE Part #5039274102
DR-25-1/4-0-CS-34034

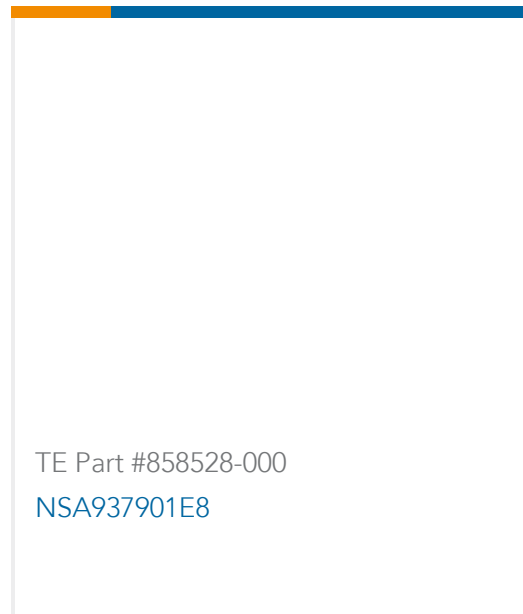

TE Part #858528-000
NSA937901E8

Documents

Product Drawings

[TERMINAL RT PIDG PEEK STRATO 10 AWG](#)

English

CAD Files

[3D PDF](#)

3D

Customer View Model

[ENG_CVM_CVM_1577647-1_B.2d_dxf.zip](#)

English

Customer View Model

[ENG_CVM_CVM_1577647-1_B.3d_igs.zip](#)

English

Customer View Model

[ENG_CVM_CVM_1577647-1_B.3d_stp.zip](#)

English

By downloading the CAD file I accept and agree to the [Terms and Conditions](#) of use.

Product Specifications

[Application Specification](#)

English

Product Environmental Compliance

[TE Material Declaration](#)

English