

1564411-2 ✓ ACTIVE

AMP | Heavy Duty Sealed Connector Series

TE Internal #: 1564411-2

Other Automotive Connector Accessories, Mounting Clip, PBT GF, Red, -40 – 140 °C [-40 – 284 °F], Heavy Duty Sealed Connector Series

[View on TE.com >](#)



Connectors > Automotive Connectors > Automotive Connector Accessories > Other Automotive Connector Accessories >

Heavy Duty Sealed Connector Series Fixing Slides

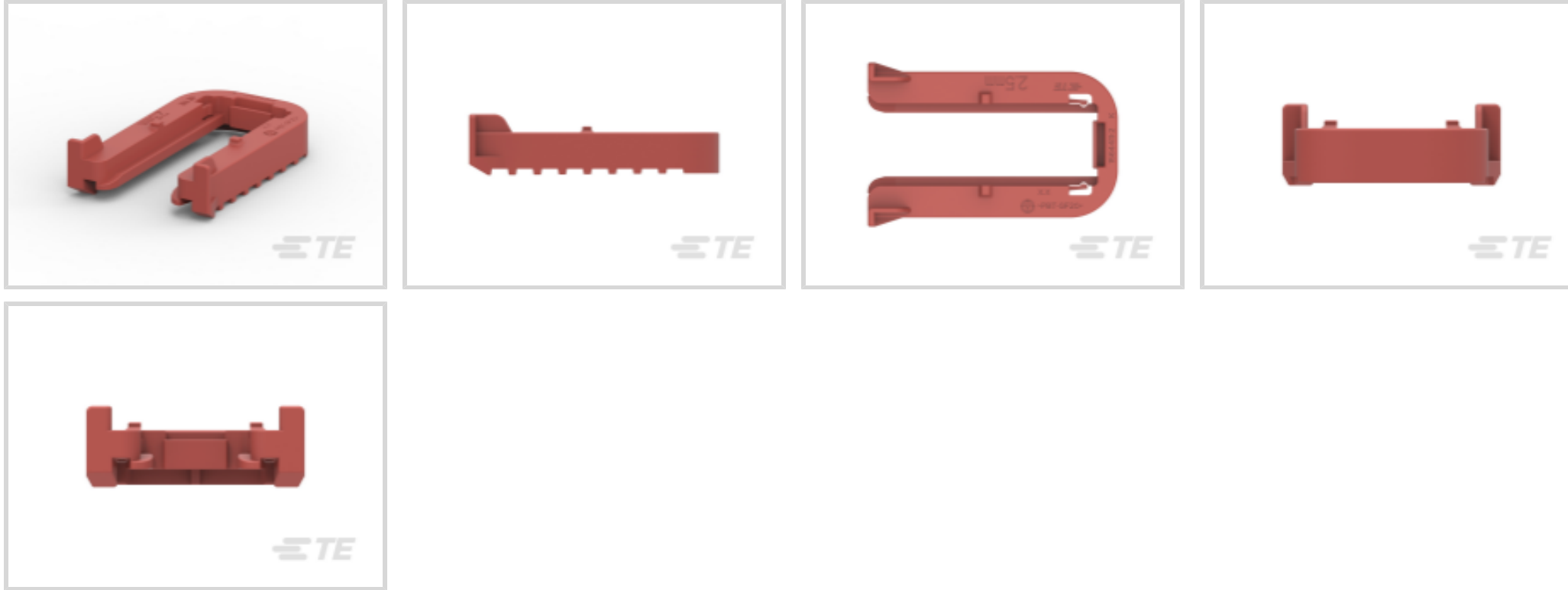

Automotive Connector Accessory Type: **Mounting Clip**

Primary Product Material: **PBT GF**

Primary Product Color: **Red**

Number of Positions: **4, 12, 15, 16, 18**

Operating Temperature Range: **-40 – 140 °C [-40 – 284 °F]**

[All Heavy Duty Sealed Connector Series Fixing Slides \(33\)](#)

## Features

### Product Type Features

Automotive Connector Accessory Type	Mounting Clip
-------------------------------------	---------------

### Configuration Features

Number of Positions	4, 12, 15, 16, 18
---------------------	-------------------

### Body Features

Primary Product Material	PBT GF
Primary Product Color	Red

### Usage Conditions

Compatible With Connector Style	Housing For Male Terminals
Operating Temperature Range	-40 – 140 °C[-40 – 284 °F]

### Industry Standards

UL Flammability Rating	UL 94V-0
------------------------	----------



### Packaging Features

Packaging Quantity	1200
Packaging Method	Carton

### Other

Serviceable	Yes
-------------	-----

### Product Compliance

[For compliance documentation, visit the product page on TE.com>](#)

EU RoHS Directive 2011/65/EU	Compliant
EU ELV Directive 2000/53/EC	Compliant
China RoHS 2 Directive MIIT Order No 32, 2016	No Restricted Materials Above Threshold
EU REACH Regulation (EC) No. 1907/2006	Current ECHA Candidate List: JUNE 2023 (235) Candidate List Declared Against: JUNE 2023 (235) Does not contain REACH SVHC
Halogen Content	Not Low Halogen - contains Br or Cl > 900 ppm.
Solder Process Capability	Not applicable for solder process capability

#### Product Compliance Disclaimer

This information is provided based on reasonable inquiry of our suppliers and represents our current actual knowledge based on the information they provided. This information is subject to change. The part numbers that TE has identified as EU RoHS compliant have a maximum concentration of 0.1% by weight in homogenous materials for lead, hexavalent chromium, mercury, PBB, PBDE, DBP, BBP, DEHP, DIBP, and 0.01% for cadmium, or qualify for an exemption to these limits as defined in the Annexes of Directive 2011/65/EU (RoHS2). Finished electrical and electronic equipment products will be CE marked as required by Directive 2011/65/EU. Components may not be CE marked. Additionally, the part numbers that TE has identified as EU ELV compliant have a maximum concentration of 0.1% by weight in homogenous materials for lead, hexavalent chromium, and mercury, and 0.01% for cadmium, or qualify for an exemption to these limits as defined in the Annexes of Directive 2000/53/EC (ELV). Regarding the REACH Regulation, the information TE provides on SVHC in articles for this part number is based on the latest European Chemicals Agency (ECHA) 'Guidance on requirements for substances in articles' posted at this URL: <https://echa.europa.eu/guidance-documents/guidance-on-reach>

### Compatible Parts



TE Part # CAT-H3399-CH8172  
Heavy Duty Sealed Connector Series Housings



TE Part # 2-1564536-1  
4POS,TAB5.8X0.8,TABHSG,ASSY, COD. B



TE Part # 9-2348789-1  
HD MATEnet 2+6 TAB ASSY, GRP E, FLANGED



TE Part # 9-2348789-2  
HD MATEnet 2+6 TAB ASSY, GRP E, FLANGED



TE Part # 2347973-1  
BLIND CONNECTOR,TAB HSG ASSY, GROUP E

Also in the Series | Heavy Duty Sealed Connector Series



Automotive Connector Caps & Covers (25)



Automotive Housings(207)



Connector Seals & Cavity Plugs(5)

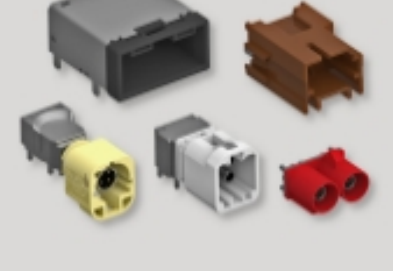

Data Connectivity Headers(2)



Data Connectivity Housings(18)



Other Automotive Connector Accessories(34)



PCB Headers & Receptacles(1)

Customers Also Bought



TE Part #765793-000  
B-106-1802



TE Part #2112045-1  
SLIDE, FOR 26POS TAB HSG



TE Part #1-2112041-1  
26POS, MIXED,TAB HSG,ASSY, SEALED



TE Part #1718329-1  
ADAPTER FOR TAB HSG 39 POS,62P

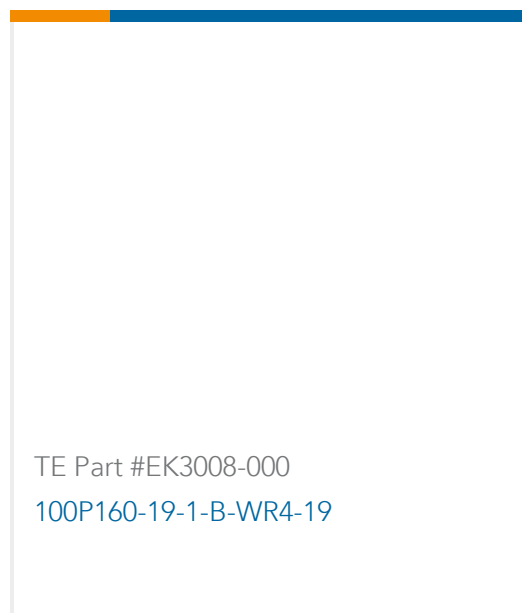
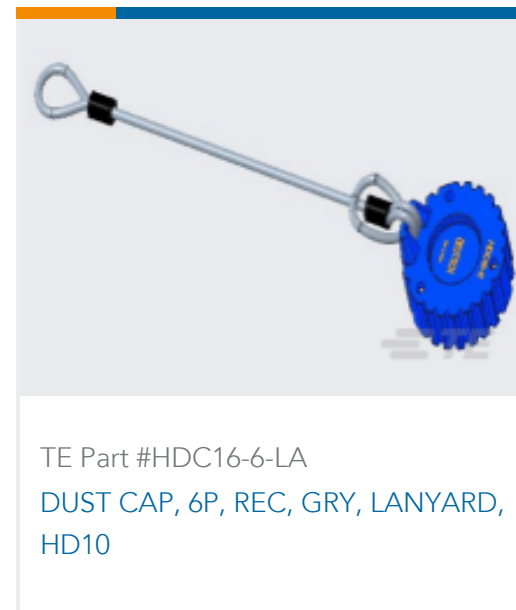
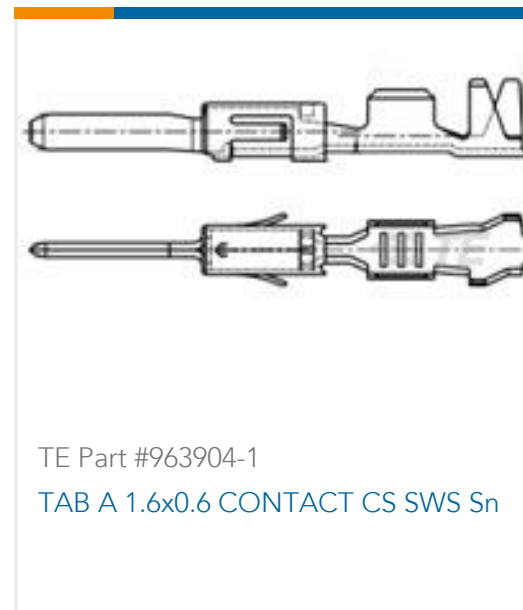

## Documents

### Product Drawings

[SLIDE,TAB HSG GROUP E](#)

English

### CAD Files

[3D PDF](#)

3D

Customer View Model

[ENG\\_CVM\\_CVM\\_1564411-2\\_L.2d\\_dxf.zip](#)

English

Customer View Model

[ENG\\_CVM\\_CVM\\_1564411-2\\_L.3d\\_igs.zip](#)

English

Customer View Model

[ENG\\_CVM\\_CVM\\_1564411-2\\_L.3d\\_stp.zip](#)

English

By downloading the CAD file I accept and agree to the [Terms and Conditions](#) of use.

### Datasheets & Catalog Pages

[HDSCS Catalog](#)

English

[CONNECTOR SELECTOR](#)

English

### Product Specifications

[Application Specification](#)

English

1564411-2

Other Automotive Connector Accessories, Mounting Clip, PBT GF, Red, -40 – 140 °C  
[-40 – 284 °F], Heavy Duty Sealed Connector Series

