

1563124-1 ✓ ACTIVE

AMP | MCON 1.2mm, MCON Interconnection System

TE Internal #: 1563124-1

Automotive Connector Locks & Position Assurance, TPA (Terminal Position Assurance), Red, PBT GF, MCON Interconnection System

[View on TE.com >](#)



Connectors > Automotive Connectors > Automotive Connector Accessories > Automotive Connector Locks & Position Assurance



Connector & Contact Retention Accessory Type: **TPA (Terminal Position Assurance)**

Primary Product Color: **Red**

Primary Product Material: **PBT GF**

Operating Temperature Range: **-40 – 140 °C [ -40 – 284 °F ]**

## Features

### Product Type Features

Connector & Contact Retention Accessory Type	TPA (Terminal Position Assurance)
--	-----------------------------------

### Body Features

Primary Product Color	Red
Primary Product Material	PBT GF

### Usage Conditions

Operating Temperature Range	-40 – 140 °C[-40 – 284 °F]
-----------------------------	----------------------------

### Industry Standards

UL Flammability Rating	UL 94HB
------------------------	---------

### Packaging Features

Packaging Quantity	3000
Packaging Method	Box & Carton

### Other

Serviceable	Yes
-------------	-----

## Product Compliance

[For compliance documentation, visit the product page on TE.com>](#)

EU RoHS Directive 2011/65/EU	Compliant
EU ELV Directive 2000/53/EC	Compliant
China RoHS 2 Directive MIIT Order No 32, 2016	No Restricted Materials Above Threshold

EU REACH Regulation (EC) No. 1907/2006

Current ECHA Candidate List: JUNE 2023 (235)

Candidate List Declared Against: JUNE 2023 (235)

Does not contain REACH SVHC

Halogen Content

Low Halogen - Br, Cl, F, I < 900 ppm per homogenous material. Also BFR/CFR/PVC Free

Solder Process Capability

Not applicable for solder process capability

Product Compliance Disclaimer

This information is provided based on reasonable inquiry of our suppliers and represents our current actual knowledge based on the information they provided. This information is subject to change. The part numbers that TE has identified as EU RoHS compliant have a maximum concentration of 0.1% by weight in homogenous materials for lead, hexavalent chromium, mercury, PBB, PBDE, DBP, BBP, DEHP, DIBP, and 0.01% for cadmium, or qualify for an exemption to these limits as defined in the Annexes of Directive 2011/65/EU (RoHS2). Finished electrical and electronic equipment products will be CE marked as required by Directive 2011/65/EU. Components may not be CE marked. Additionally, the part numbers that TE has identified as EU ELV compliant have a maximum concentration of 0.1% by weight in homogenous materials for lead, hexavalent chromium, and mercury, and 0.01% for cadmium, or qualify for an exemption to these limits as defined in the Annexes of Directive 2000/53/EC (ELV). Regarding the REACH Regulation, the information TE provides on SVHC in articles for this part number is based on the latest European Chemicals Agency (ECHA) 'Guidance on requirements for substances in articles' posted at this URL: <https://echa.europa.eu/guidance-documents/guidance-on-reach>

## Compatible Parts



TE Part # 1563123-1  
10POS, MIXED, REC HSG



TE Part # 1563123-2  
10POS, MIXED, REC HSG

## Also in the Series | MCON 1.2mm



Automotive Connector Caps & Covers (9)

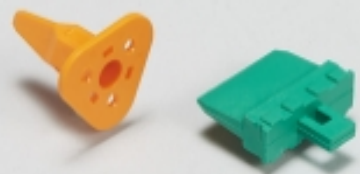

Automotive Connector Locks & Position Assurance(9)



Automotive Housings(21)

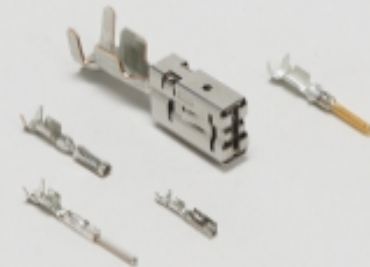

Automotive Terminals(16)

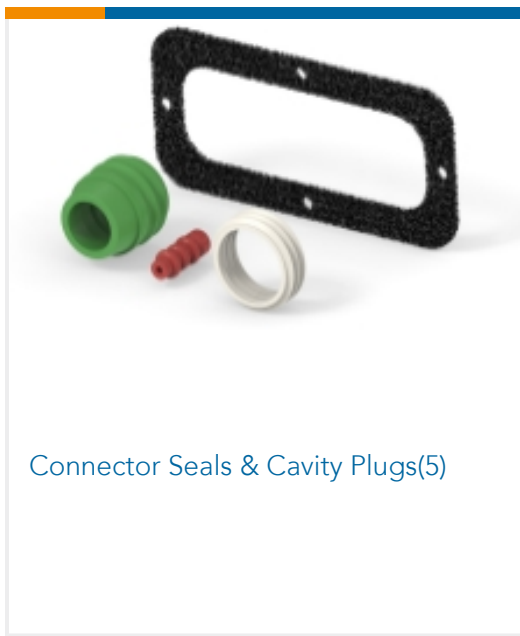

Connector Seals & Cavity Plugs(5)

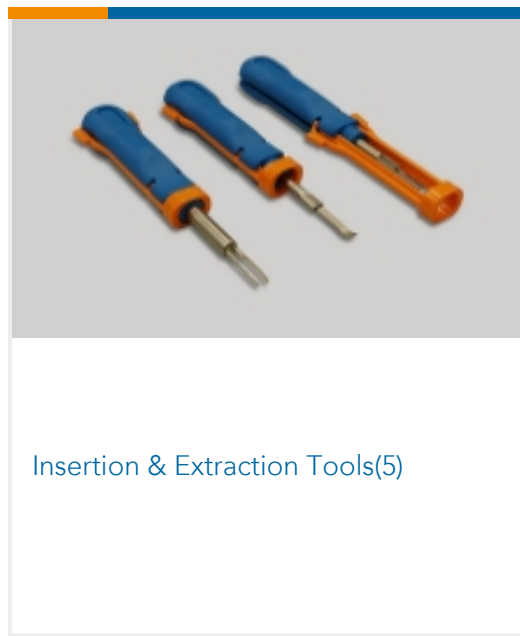

Insertion & Extraction Tools(5)

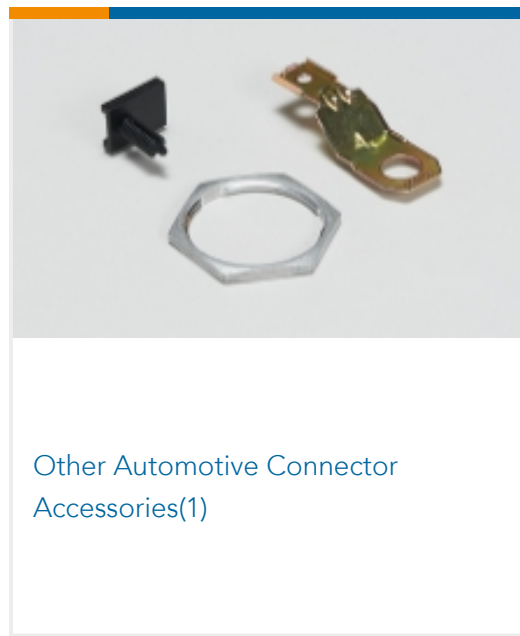

Other Automotive Connector Accessories(1)

## Also in the Series | MCON Interconnection System

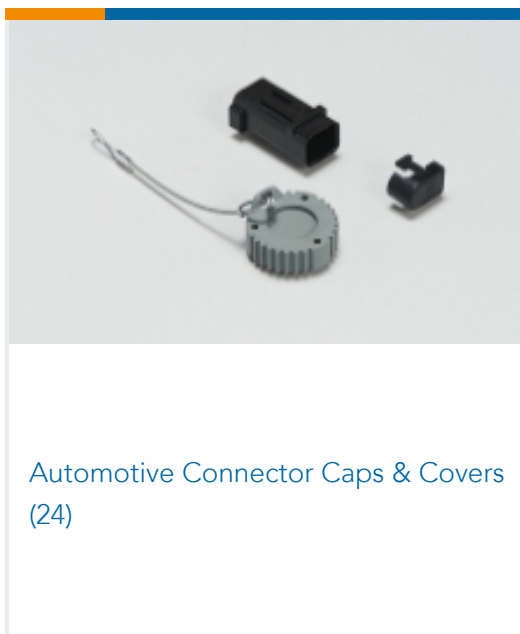

Automotive Connector Caps & Covers (24)



Automotive Connector Locks & Position Assurance(11)

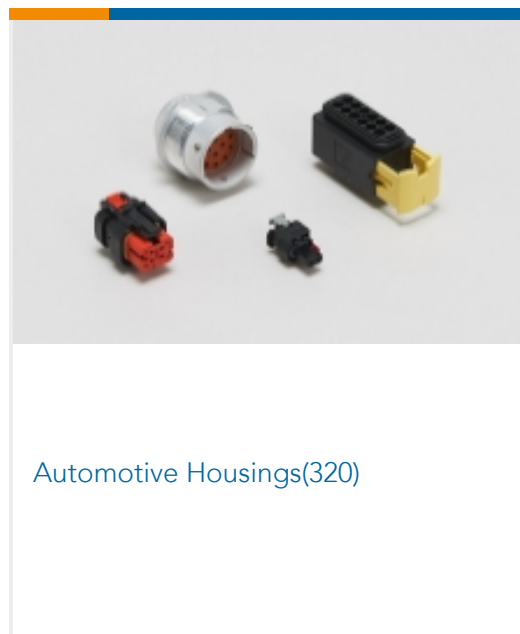

Automotive Housings(320)

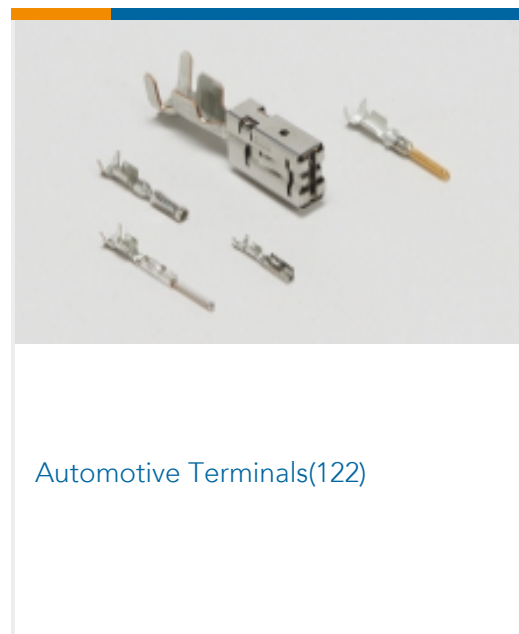

Automotive Terminals(122)

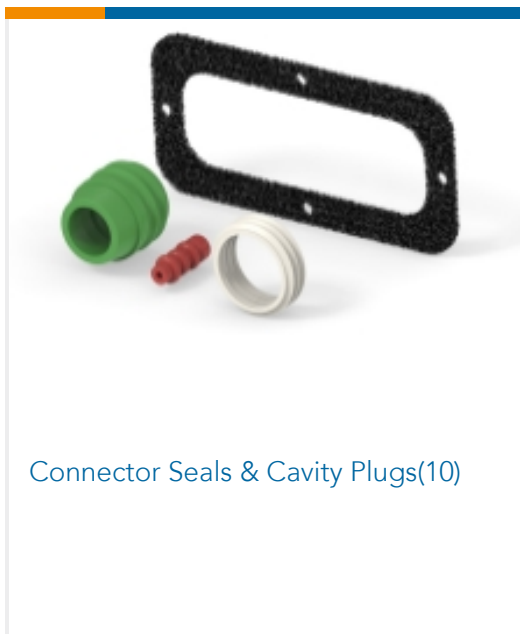

Connector Seals & Cavity Plugs(10)

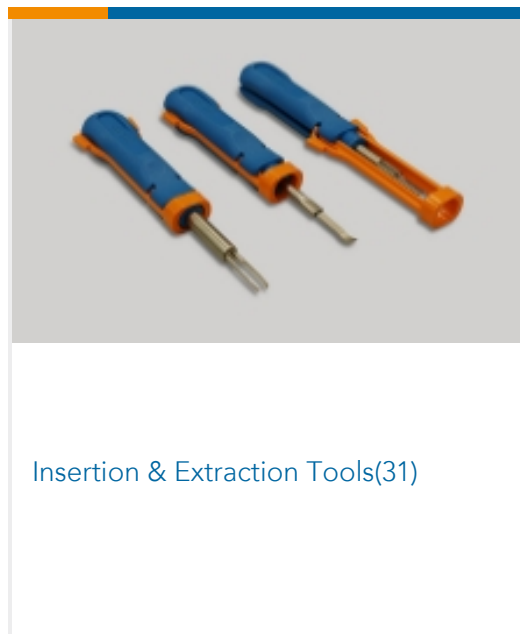

Insertion & Extraction Tools(31)

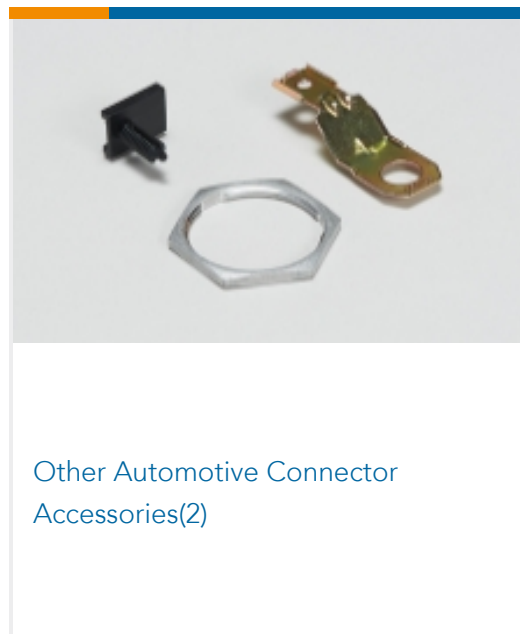

Other Automotive Connector Accessories(2)



PCB Headers & Receptacles(2)

## Customers Also Bought

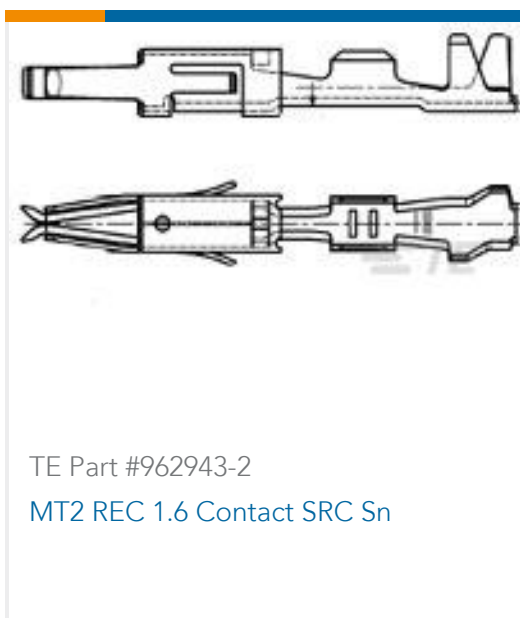

TE Part #962943-2  
MT2 REC 1.6 Contact SRC Sn



TE Part #1703874-1  
MQS, CONNECTOR HOUSING



TE Part #1241390-1  
AMP MCP 2.8K, CONTACT



TE Part #7-1452656-1  
MCON Receptacle and Tab



TE Part #2177000-1  
10POS,0.64 GENER. Y,REC HSG,ASSY



TE Part #881507-5  
FF 110 REC 0.5-1.5 MM2 0.25 X 12.3 PTPBR

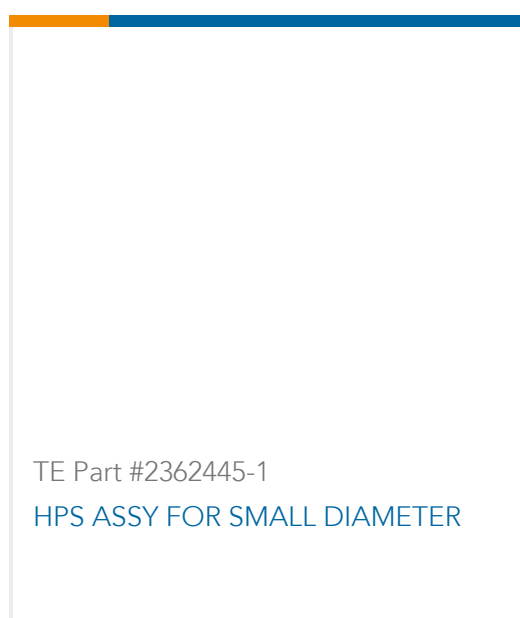

TE Part #2362445-1  
HPS ASSY FOR SMALL DIAMETER



## Documents

### Product Drawings

#### 2. LOCK,10 POS FEM HOUSING

English

---

### CAD Files

#### 3D PDF

3D

#### Customer View Model

[ENG\\_CVM\\_CVM\\_1563124-1\\_A.2d\\_dxf.zip](#)

English

#### Customer View Model

[ENG\\_CVM\\_CVM\\_1563124-1\\_A.3d\\_igs.zip](#)

English

#### Customer View Model

[ENG\\_CVM\\_CVM\\_1563124-1\\_A.3d\\_stp.zip](#)

English

By downloading the CAD file I accept and agree to the [Terms and Conditions](#) of use.

---

### Product Specifications

#### Application Specification

English

---

### Product Environmental Compliance

#### Product Compliance

English

#### Product Compliance

English