

1554723-1 ✓ ACTIVE

AMP | SUPERSEAL 1.0mm

TE Internal #: 1554723-1

Automotive Terminals, Receptacle, Mating Tab Width 1 mm [.039 in], 20 – 18 AWG Wire Size, .5 – .85 mm² Wire Size, Sealable, SUPERSEAL 1.0mm

[View on TE.com >](#)



Terminals & Splices > Automotive Terminals > SUPERSEAL Connector Contacts: 1.0 mm

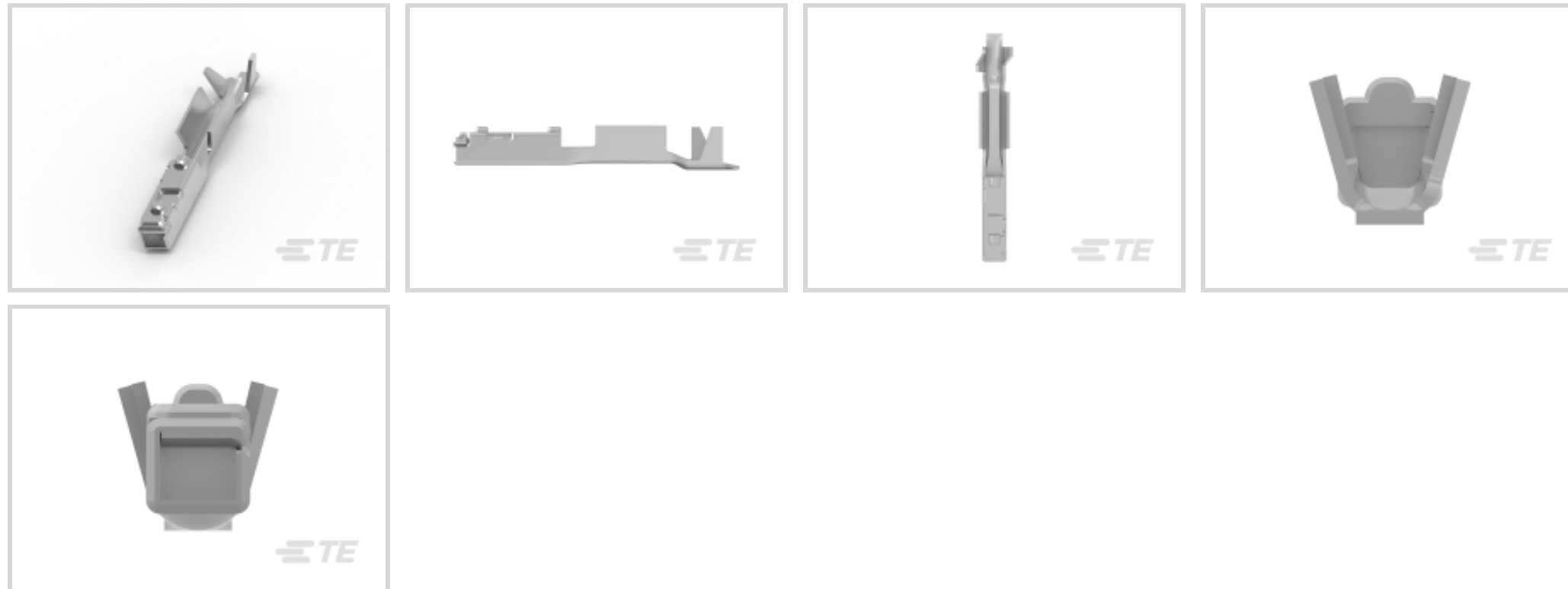

Terminal Type: **Receptacle**

Mating Tab Width: 1 mm [.039 in]

Wire Size: .5 – .85 mm²

Sealable: **Yes**

[All SUPERSEAL Connector Contacts: 1.0 mm \(6\)](#)

Features

Product Type Features

Receptacle Style	180°
Sealable	Yes

Body Features

Terminal Seal Type	Family Seal
--------------------	-------------

Contact Features

Contact Size	1mm
Contact Fabrication	Stamped & Formed
Wire Contact Termination Area Plating Material	Tin
Crimp Type	F-Crimp
Terminal Type	Receptacle
Mating Tab Width	1 mm [.039 in]
Interface Plating	Tin (Sn)

Termination Features



Termination Method to Wire & Cable	Crimp
------------------------------------	-------

Product Terminates To	Wire
-----------------------	------

Dimensions

Wire Size	.5 – .85 mm ²
-----------	--------------------------

Wire Size Search	18 AWG, 19 AWG, 20 AWG
------------------	------------------------

Usage Conditions

Insulation Option	Uninsulated
-------------------	-------------

Operating Temperature (Max)	80 °C, 85 °C, 90 °C, 100 °C, 105 °C, 110 °C, 120 °C, 125 °C[176 °F][185 °F][194 °F][212 °F] [221 °F][230 °F][248 °F][257 °F]
-----------------------------	--

Operating Temperature Range	-40 – 125 °C[-40 – 257 °F]
-----------------------------	----------------------------

Operation/Application

Compatible With Wire Base Material	Copper
------------------------------------	--------

Packaging Features

Packaging Quantity	8000
--------------------	------

Packaging Method	Reel
------------------	------

Product Compliance

[For compliance documentation, visit the product page on TE.com>](#)

EU RoHS Directive 2011/65/EU	Compliant
------------------------------	-----------

EU ELV Directive 2000/53/EC	Compliant
-----------------------------	-----------

China RoHS 2 Directive MIIT Order No 32, 2016	No Restricted Materials Above Threshold
---	---

EU REACH Regulation (EC) No. 1907/2006	Current ECHA Candidate List: JUNE 2023 (235) Candidate List Declared Against: JUNE 2023 (235) Does not contain REACH SVHC
--	---

Halogen Content	Low Halogen - Br, Cl, F, I < 900 ppm per homogenous material. Also BFR/CFR/PVC Free
-----------------	---

Solder Process Capability	Not reviewed for solder process capability
---------------------------	--

Product Compliance Disclaimer

This information is provided based on reasonable inquiry of our suppliers and represents our current actual knowledge based on the information they provided. This information is subject to change. The part numbers that TE has identified as EU RoHS compliant have a maximum concentration of 0.1% by weight in homogenous materials for lead, hexavalent chromium, mercury, PBB, PBDE, DBP, BBP, DEHP, DIBP, and 0.01% for cadmium, or qualify for an exemption to these limits as defined in the Annexes of Directive 2011/65/EU (RoHS2). Finished electrical and electronic equipment products



will be CE marked as required by Directive 2011/65/EU. Components may not be CE marked. Additionally, the part numbers that TE has identified as EU ELV compliant have a maximum concentration of 0.1% by weight in homogenous materials for lead, hexavalent chromium, and mercury, and 0.01% for cadmium, or qualify for an exemption to these limits as defined in the Annexes of Directive 2000/53/EC (ELV). Regarding the REACH Regulation, the information TE provides on SVHC in articles for this part number is based on the latest European Chemicals Agency (ECHA) 'Guidance on requirements for substances in articles' posted at this URL: <https://echa.europa.eu/guidance-documents/guidance-on-reach>

Compatible Parts



TE Part # 2305570-1
Strip Terminal Cutter-Side Feed-No Crimp



TE Part # 2-2151287-1
OCEAN-2.0-APPLICATOR-S-062F0700



TE Part # 2-2151287-2
OCEAN-2.0-APPLICATOR-S-062F0700A



TE Part # 2151287-1
OCEAN-2.0-APPLICATOR-S-062F0700



TE Part # 2151287-2
OCEAN-2.0-APPLICATOR-S-062F0700A



TE Part # 2290490-1
16POS,1.0 SERIES,REC HSG ASSY,SLD



TE Part # 5-2151287-1
OCEAN-2.0-APPLICATOR-S-062F0700



TE Part # 5-2151287-2
OCEAN-2.0-APPLICATOR-S-062F0700A



TE Part # 7-2151287-1
OCEAN-2.0-APPLICATOR-S-062F0700



TE Part # 7-2151287-2
OCEAN-2.0-APPLICATOR-S-062F0700A



TE Part # 7-2151287-7
OCEAN_2.0_SPARE_PART_KIT-062F0700



TE Part # 7-2836984-7
OC-062F-0700-CRIMPTOOLINGKIT

Also in the Series | SUPERSEAL 1.0mm



Automotive Housings(12)

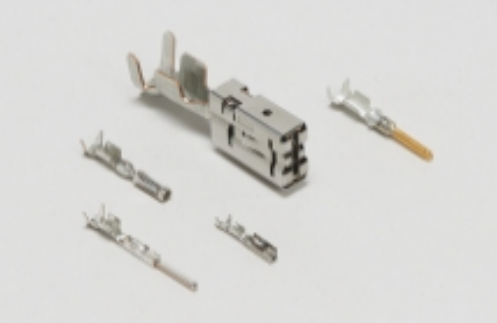

Automotive Terminals(6)



Connector Seals & Cavity Plugs(1)



PCB Headers & Receptacles(30)

Customers Also Bought



TE Part #2305186-1
44POS,PR SPRNG CONTACT,REC
HSG ASSY,SLD



TE Part #1-2066502-4
COVER 2 POS MINI FUSE BOX,MAT-2



TE Part #1-2236898-1
5POS, MCON 1.2 LL REC SEALED



TE Part #1719668-1
2.LOCK REC HSG



TE Part #2066046-3
2 POS MINI FUSE BOX ASSY

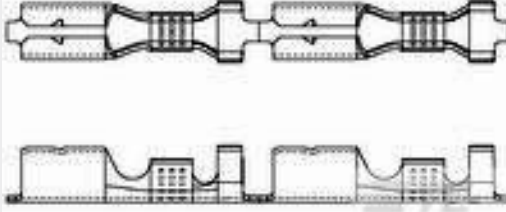

TE Part #626399-1
.140 SHUR PLUG REC.

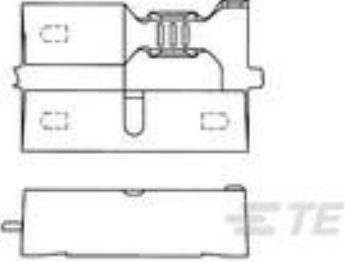

TE Part #880142-1
.156 DIA SHUR PLUG REC



TE Part #2112758-1
COVER

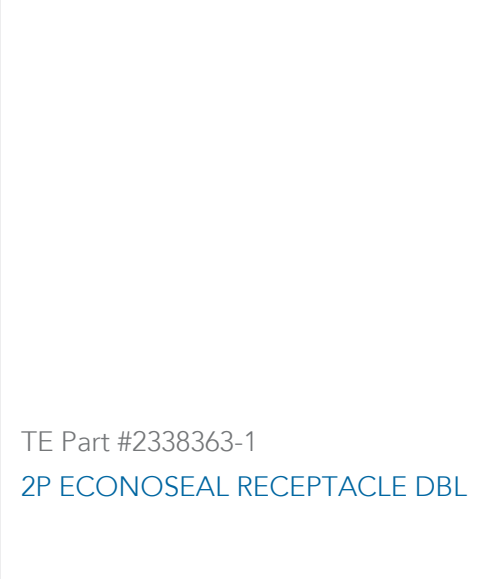

TE Part #2338363-1
2P ECONOSEAL RECEPTACLE DBL



TE Part #CV16686001
RNF-3000-NR553-0-17MM

Documents

Product Drawings

[1.0 SEALED RECEPTACLE CONTACT](#)

Japanese

CAD Files

[3D PDF](#)

3D

Customer View Model

[ENG_CVM_CVM_1554723-1_B.2d_dxf.zip](#)

English

Customer View Model

[ENG_CVM_CVM_1554723-1_B.3d_igs.zip](#)

English

Customer View Model

[ENG_CVM_CVM_1554723-1_B.3d_stp.zip](#)

English

By downloading the CAD file I accept and agree to the [Terms and Conditions](#) of use.

Datasheets & Catalog Pages



ICT Terminals and Connectors Catalogue

English

Product Specifications

Application Specification

Japanese

Application Specification

Japanese

Instruction Sheets

Instruction Sheet (non U.S.)

Japanese