

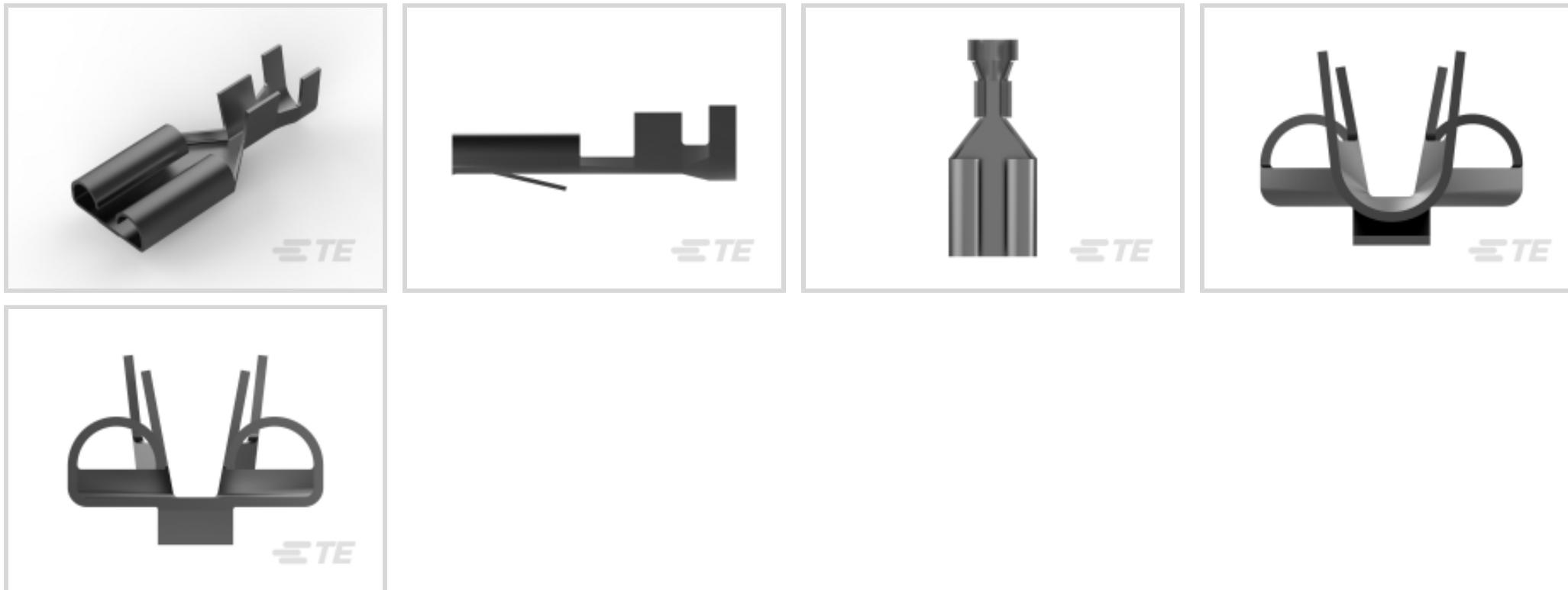

Terminals & Splices > Quick Disconnects



Quick Disconnect Terminal Type: **Receptacle**

Wire Size: **4 – 5.2 mm<sup>2</sup>**

Mating Tab Width: **9.53 mm [.375 in]**

Mating Tab Thickness: **1.22 mm [.048 in]**

### Features

#### Product Type Features

Insertion Force	Normal
-----------------	--------

#### Configuration Features

Connection Capacity	Single
Compatible With Wire & Cable Type	Discrete Wire

#### Contact Features

Quick Disconnect Terminal Type	Receptacle
Mating Tab Width	9.53 mm[.375 in]
Mating Tab Thickness	1.22 mm[.048 in]
Terminal Orientation	Straight
Contact Base Material	Brass
Terminal Plating Material	Tin
Crimp Type	F-Crimp
Barrel Type	Open

#### Termination Features

--	--



Product Terminates To	Wire & Cable
-----------------------	--------------

### Mechanical Attachment

Wire Insulation Support	With
Mating Retention Type	Locking Lance

### Dimensions

Terminal Material Thickness	.41 mm[.016 in]
Product Length	26.42 mm[1.04 in]
Compatible Insulation Diameter Range	4.1 – 5.3 mm[.161 – .209 in]
Wire Size	4 – 5.2 mm <sup>2</sup>

### Usage Conditions

Insulation Option	Uninsulated
Operating Temperature Range	-40 – 110 °C[-40 – 230 °F]

### Packaging Features

Packaging Quantity	2000
Packaging Method	Strip/Reel

### Product Compliance

[For compliance documentation, visit the product page on TE.com>](#)







EU RoHS Directive 2011/65/EU	Compliant
EU ELV Directive 2000/53/EC	Compliant
China RoHS 2 Directive MIIT Order No 32, 2016	No Restricted Materials Above Threshold
EU REACH Regulation (EC) No. 1907/2006	Current ECHA Candidate List: JUNE 2023 (235) Candidate List Declared Against: JUNE 2023 (235) Does not contain REACH SVHC
Halogen Content	Low Halogen - Br, Cl, F, I < 900 ppm per homogenous material. Also BFR/CFR/PVC Free
Solder Process Capability	Not applicable for solder process capability

#### Product Compliance Disclaimer

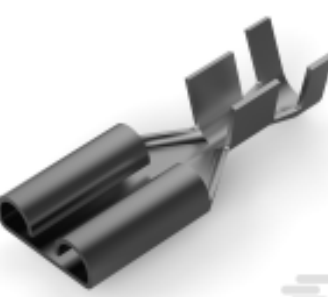
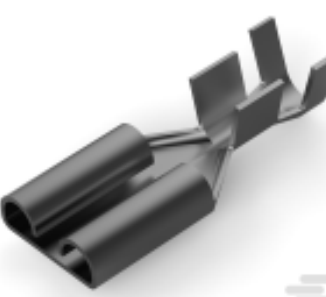

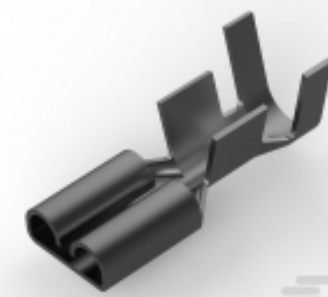
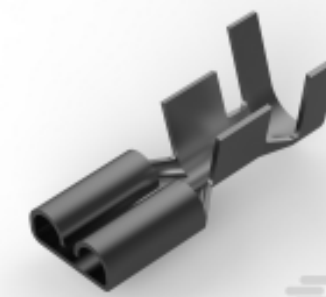
This information is provided based on reasonable inquiry of our suppliers and represents our current actual knowledge based on the information they provided. This information is subject to change. The part numbers that TE has identified as EU RoHS compliant have a maximum concentration of 0.1% by weight in homogenous materials for lead, hexavalent chromium, mercury, PBB, PBDE, DBP, BBP, DEHP, DIBP, and 0.01% for cadmium, or qualify for an exemption to these limits as defined in the Annexes of Directive 2011/65/EU (RoHS2). Finished electrical and electronic equipment products will be CE marked as required by Directive 2011/65/EU. Components may not be CE marked. Additionally, the part

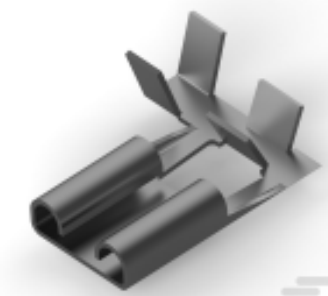
numbers that TE has identified as EU ELV compliant have a maximum concentration of 0.1% by weight in homogenous materials for lead, hexavalent chromium, and mercury, and 0.01% for cadmium, or qualify for an exemption to these limits as defined in the Annexes of Directive 2000/53/EC (ELV). Regarding the REACH Regulation, the information TE provides on SVHC in articles for this part number is based on the latest European Chemicals Agency (ECHA) 'Guidance on requirements for substances in articles' posted at this URL: <https://echa.europa.eu/guidance-documents/guidance-on-reach>

## Compatible Parts

 <p>TE Part # 280755-4 FF 375 REC 6-10MM2 TPPB</p>	 <p>TE Part # 280756-4 FF 375 REC 3-6MM2 TPPB</p>	 <p>TE Part # 280756-2 FF 375 REC 3-6MM2 TPBR</p>	 <p>TE Part # 280755-2 FF 375 REC 6-10MM2 TPBR</p>
 <p>TE Part # 281091-2 FF 375 REC 6-10MM2 TPBR</p>	 <p>TE Part # 160914-2 FF 250 REC 4-6MM2 TPBR</p>	 <p>TE Part # 160914-4 FF 250 REC 4-6MM2 TPPB</p>	 <p>TE Part # 280074-2 FF 375 TAB 6-10MM2 PTBR</p>
 <p>TE Part # 151667-4 FF 375 REC TERMINAL 11-10 AWG PBR</p>	 <p>TE Part # 1-180453-2 FF 312 REC 1-2.5MM2</p>	 <p>TE Part # 170268-2 FF 375 REC 6-10MM2 TPBR</p>	

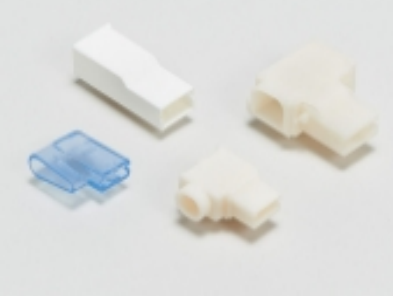
## Also in the Series | FASTIN-FASTON 375

 <p>Crimp Terminal Housings(9)</p>	 <p>Insertion &amp; Extraction Tools(1)</p>	 <p>Quick Disconnects(20)</p>
---	--	--

## Customers Also Bought

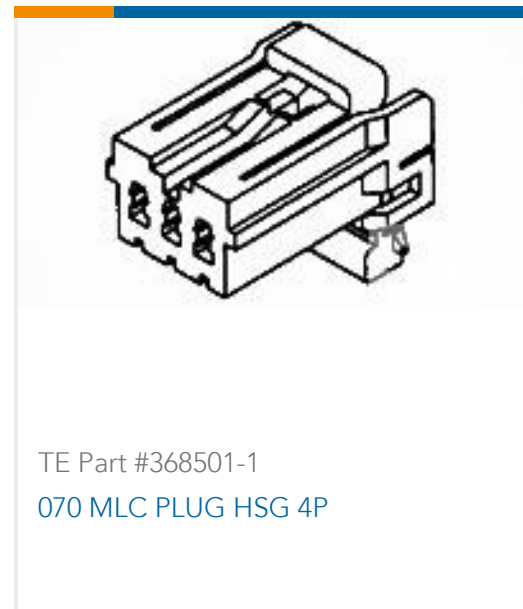
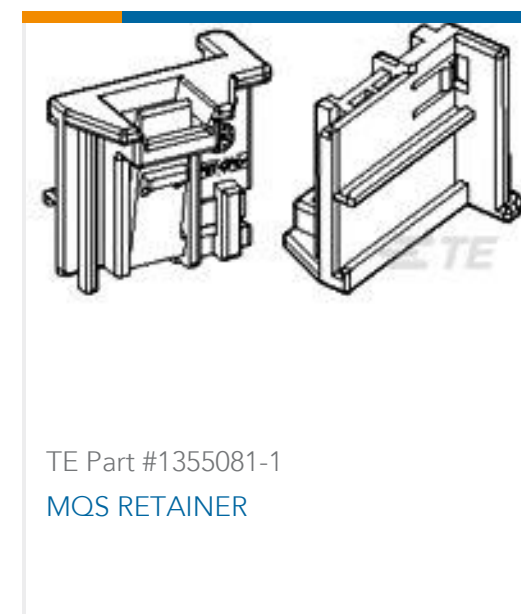

## Documents

### Product Drawings

[FF 375 REC 4-6MM2 TPBR](#)

English

### CAD Files

[3D PDF](#)

3D

Customer View Model

[ENG\\_CVM\\_CVM\\_151667-2\\_AD.2d\\_dxf.zip](#)

English

Customer View Model

[ENG\\_CVM\\_CVM\\_151667-2\\_AD.3d\\_igs.zip](#)

English

Customer View Model

[ENG\\_CVM\\_CVM\\_151667-2\\_AD.3d\\_stp.zip](#)

English

By downloading the CAD file I accept and agree to the [Terms and Conditions](#) of use.

### Datasheets & Catalog Pages



## 1654742\_HOUSEHOLD\_APPLIANCES\_RAST5

English

---

### Product Specifications

FASTIN-FASTON CONN. .110 INCH, .187 INCH, .250 INCH, .375 INCH SRS.

English

### Product Specification

English

---

### Product Environmental Compliance

#### Product Compliance

English

#### Product Compliance

English