

146845-1 ✓ ACTIVE



TE Internal #: 146845-1
DC Jack Connectors, Board-to-Board, 5 Position, .197 in [5 mm]
Centerline, Receptacle, 50 VDC, Vertical, Printed Circuit Board,
Power & Signal

[View on TE.com >](#)

Connectors > PCB Connectors > Battery Connectors & Holders > DC Jack Connectors

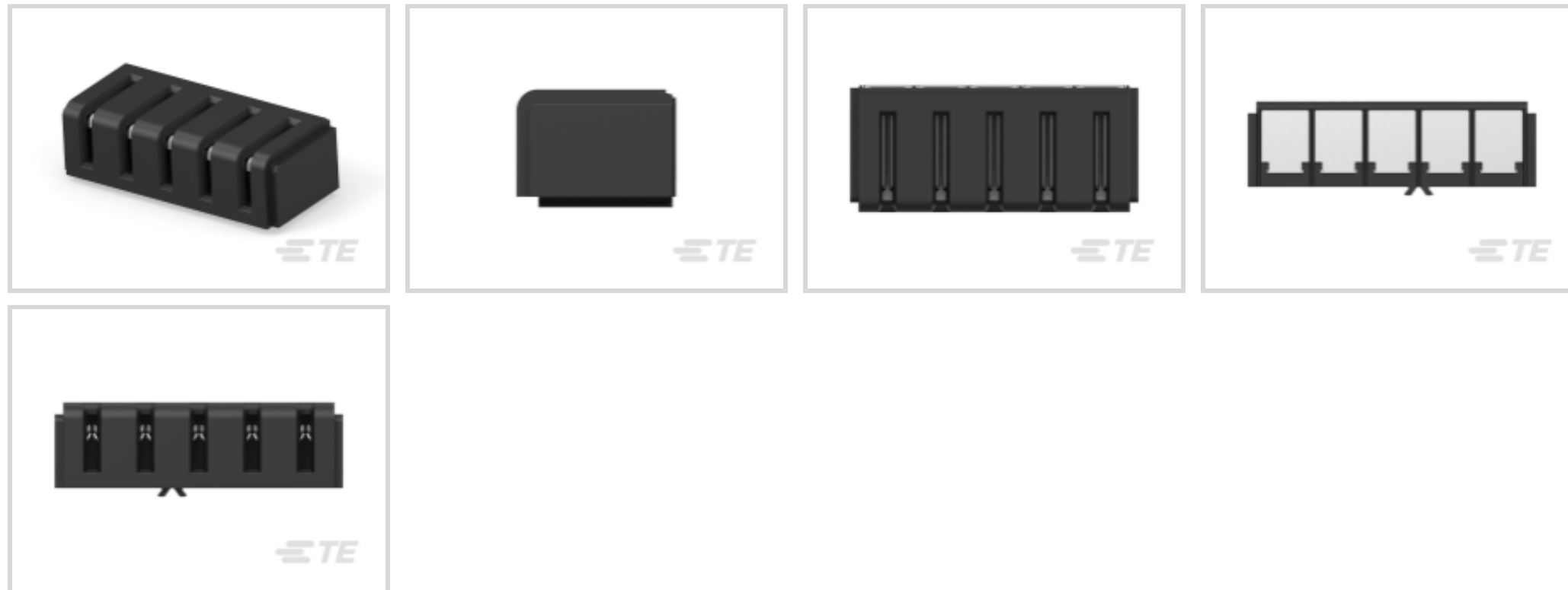

Connector System: **Board-to-Board**

Number of Positions: **5**

Centerline (Pitch): **5 mm [.197 in]**

Connector & Housing Type: **Receptacle**

Operating Voltage: **50 VDC**

Features

Product Type Features

Connector System	Board-to-Board
Connector & Housing Type	Receptacle
Connector & Contact Terminates To	Printed Circuit Board

Configuration Features

Number of Positions	5
PCB Mount Orientation	Vertical

Electrical Characteristics

Operating Voltage	50 VDC
-------------------	--------

Contact Features

Contact Mating Area Plating Material	Nickel
Contact Underplating Material	Nickel
PCB Contact Termination Area Plating Material	Tin-Lead
Contact Current Rating (Max)	8.8 A

Mechanical Attachment



PCB Mount Retention	Without
---------------------	---------

Connector Mounting Type	Board Mount
-------------------------	-------------

Housing Features

Centerline (Pitch)	5 mm [.197 in]
--------------------	----------------

Usage Conditions

Operating Temperature Range	-30 – 70 °C [-22 – 158 °F]
-----------------------------	----------------------------

Operation/Application

Circuit Application	Power & Signal
---------------------	----------------

Packaging Features

Packaging Quantity	121
--------------------	-----

Packaging Method	Box
------------------	-----

Product Compliance

[For compliance documentation, visit the product page on TE.com>](#)

EU RoHS Directive 2011/65/EU	Compliant
------------------------------	-----------

EU ELV Directive 2000/53/EC	Compliant
-----------------------------	-----------

China RoHS 2 Directive MIIT Order No 32, 2016	No Restricted Materials Above Threshold
---	---

EU REACH Regulation (EC) No. 1907/2006	Current ECHA Candidate List: JUNE 2023 (235) Candidate List Declared Against: JUNE 2023 (235) Does not contain REACH SVHC
--	---

Halogen Content	Not Low Halogen - contains Br or Cl > 900 ppm.
-----------------	--

Solder Process Capability	Wave solder capable to 240°C
---------------------------	------------------------------

Product Compliance Disclaimer

This information is provided based on reasonable inquiry of our suppliers and represents our current actual knowledge based on the information they provided. This information is subject to change. The part numbers that TE has identified as EU RoHS compliant have a maximum concentration of 0.1% by weight in homogenous materials for lead, hexavalent chromium, mercury, PBB, PBDE, DBP, BBP, DEHP, DIBP, and 0.01% for cadmium, or qualify for an exemption to these limits as defined in the Annexes of Directive 2011/65/EU (RoHS2). Finished electrical and electronic equipment products will be CE marked as required by Directive 2011/65/EU. Components may not be CE marked. Additionally, the part numbers that TE has identified as EU ELV compliant have a maximum concentration of 0.1% by weight in homogenous materials for lead, hexavalent chromium, and mercury, and 0.01% for cadmium, or qualify for an exemption to these limits as defined in the Annexes of Directive 2000/53/EC (ELV). Regarding the REACH Regulation, the information TE provides on SVHC in articles for this part number is based on the latest European Chemicals Agency (ECHA) 'Guidance on requirements for substances in articles' posted at this URL: <https://echa.europa.eu/guidance-documents/guidance-on-reach>

Compatible Parts



TE Part # 5787422-1
HDR ASY,RA,RKEY,STR TAIL,12.0V

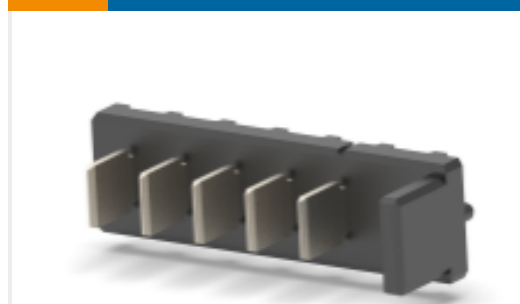

TE Part # 5787421-1
HDR ASY,VERT,RET TAIL,10.8V



TE Part # 5787430-1
HDR ASY,VERT,STR TAIL,12.0V

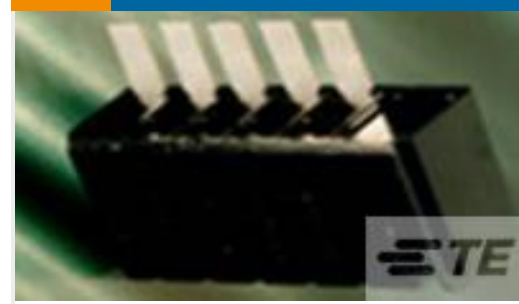

TE Part # 5146800-1
BATT INT,KEYLESS,5P,7.2V

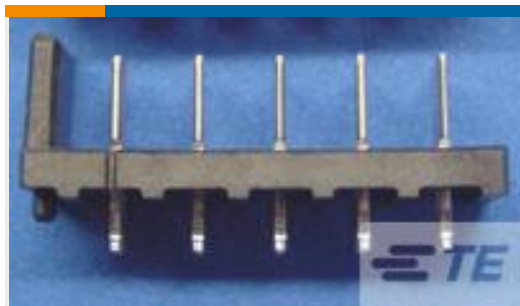

TE Part # 5787419-1
HDR ASY,VERT,STR TAIL,10.8V



TE Part # 5787590-1
BATT INT,INSERT ASSY,5P,7.2V

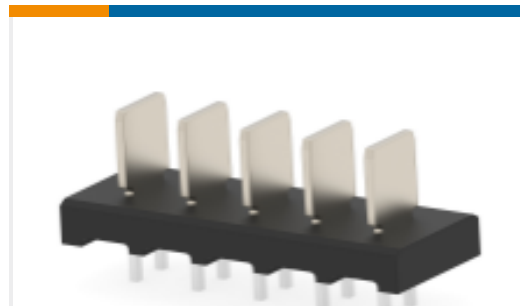

TE Part # 5787444-1
HDR ASY,VERT,NO KEY,STR TAIL

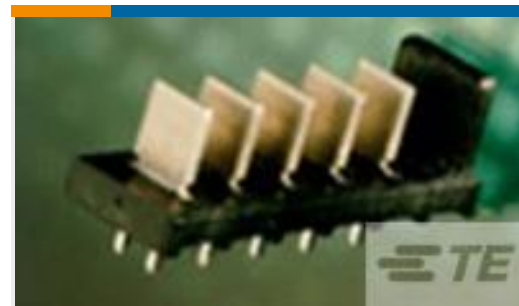

TE Part # 5787334-1
HDR ASY,VERT,STR TAIL,7.2V



TE Part # 787614-1
BAT INT,INS ASY W/TAB,5P,10.8V

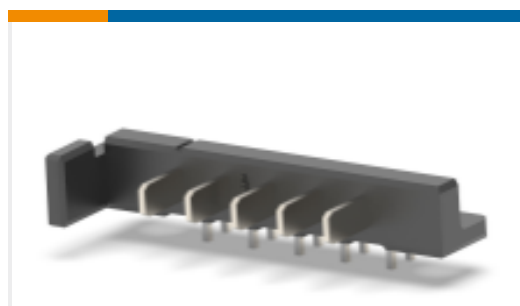

TE Part # 5787246-1
HDR ASY,RA,LKEY,STR TAIL,10.8V

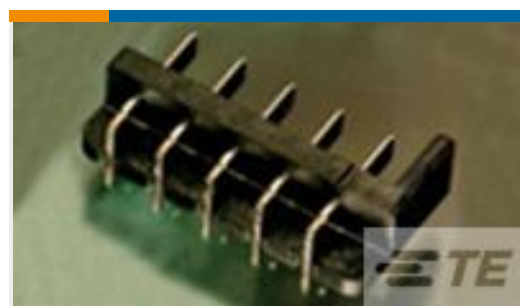

TE Part # 5787428-1
HDR ASY,RA,LKEY,STR TAIL,12.0V

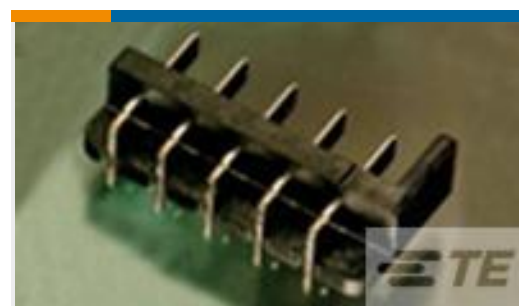

TE Part # 5787443-1
HDR ASY,RA,NO KEY,RET TAIL



TE Part # 787328-1
BATT INT,INSERT ASSY,5P,7.2V



TE Part # 787439-1
BATT INT,INSERT ASSY,5P,12.0V



TE Part # 787615-1
BAT INT,INS ASY W/TAB,5P,12.0V

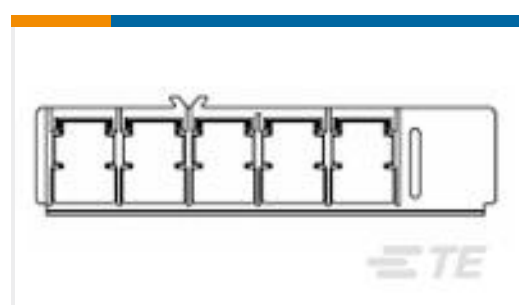

TE Part # 5787802-1
BATT RCPT ASSY,5P,10.8V



TE Part # 5796078-1
HDR ASSY,RA,KEYLESS,5POS

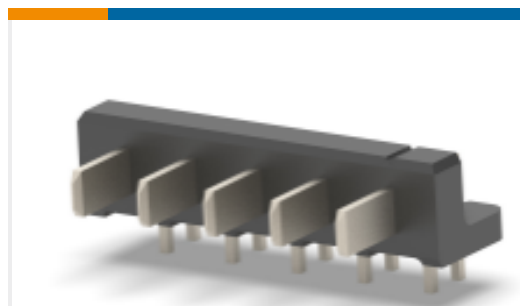

TE Part # 5787441-1
HDR ASY,RA,NO KEY,STR TAIL

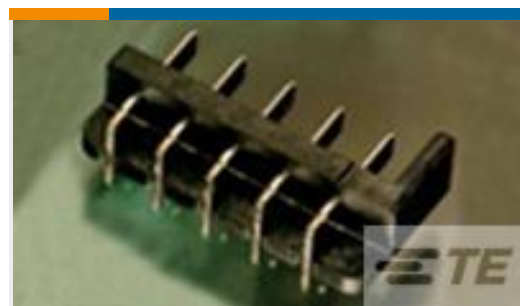

TE Part # 5787366-1
HDR ASY,RA,RKEY,STR TAIL,12.0V

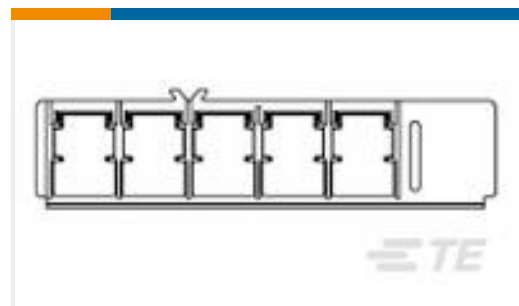

TE Part # 5787590-2
BATT INT,INSERT ASSY,5P,7.2V

Customers Also Bought



TE Part #5-103635-4
05 MTE HDR SRRA LTCH.100CL LF

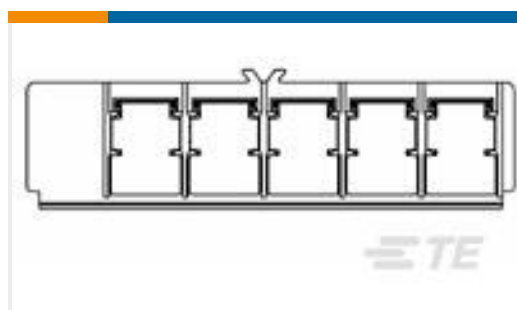

TE Part #787328-1
BATT INT,INSERT ASSY,5P,7.2V



TE Part #E24145-000
HW-229064-10-9

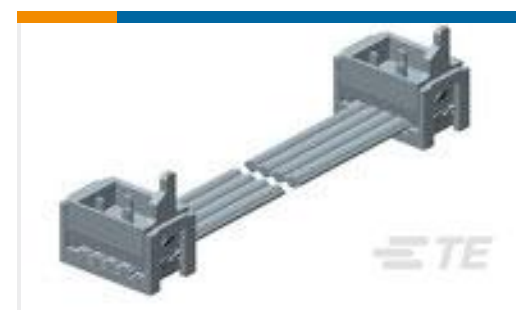

TE Part #2205061-1
CA MICRO-MATCH MOW-MOW
6POS



TE Part #5226993-2
VERTICAL JACK, BNC PCB

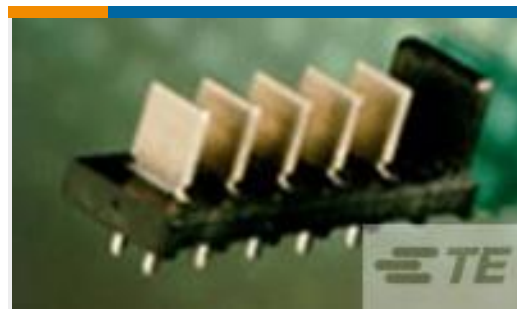

TE Part #5787446-1
HDR ASY,VERT,NO KEY,RET TAIL

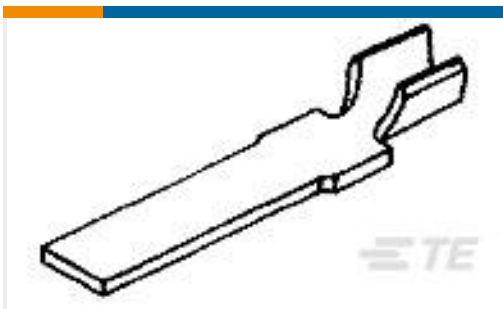

TE Part #62827-1
WELD TAB 24-22 AWG SST



TE Part #3-456403-9
CRIMPER, WIRE .062 "F"

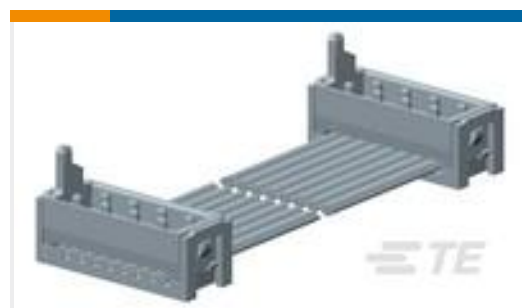

TE Part #1483352-1
MICRO-MATCH LEAD 08P 100MM

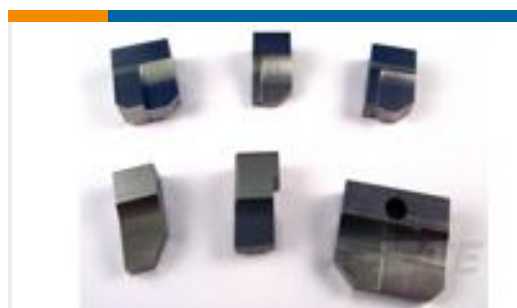

TE Part #6-805887-6
ANVIL, COMBINATION

Documents

Product Drawings

[BATT INT,KEYLESS,5P,7.2V](#)

English

CAD Files

Customer View Model

[ENG_CVM_146845-1_B.3d_igs.zip](#)

English

Customer View Model

[ENG_CVM_146845-1_B.3d_stp.zip](#)

English

Customer View Model

[ENG_CVM_146845-1_B.2d_dxf.zip](#)

English

[3D PDF](#)

English

By downloading the CAD file I accept and agree to the [Terms and Conditions](#) of use.

Datasheets & Catalog Pages



[POWER_CONNECTORS_CATALOG_SEC09_LAPTOPS_PORTABLES](#)

English

[2_PIECE_POWER_CONNECTORS_qrg_4-1773458-1](#)

English

[Product Specifications](#)

[Application Specification](#)

English

[Product Environmental Compliance](#)

[Product Compliance](#)

English

[Product Compliance](#)

English