

1418985-2 ✓ ACTIVE

AMP | Junior Power Timer

TE Internal #: 1418985-2

Automotive Connector Caps & Covers, Cable Clamp, Black, PBT GF, -40 – 302 °F [-40 – 150 °C], Junior Power Timer

[View on TE.com >](#)



Connectors > Automotive Connectors > Automotive Connector Accessories > Automotive Connector Caps & Covers > TIMER ACCESSORIES



Protection & Strain Relief Accessory Type: **Cable Clamp**

Primary Product Color: **Black**

Primary Product Material: **PBT GF**

Operating Temperature (Max): **150 °C [302 °F]**

Operating Temperature Range: **-40 – 150 °C [-40 – 302 °F]**

[All TIMER ACCESSORIES \(2\)](#)

Features

Product Type Features

Protection & Strain Relief Accessory Type	Cable Clamp
---	-------------

Body Features

Primary Product Color	Black
Primary Product Material	PBT GF

Usage Conditions

Operating Temperature (Max)	150 °C[302 °F]
Operating Temperature Range	-40 – 150 °C[-40 – 302 °F]

Industry Standards

UL Flammability Rating	UL 94HB
------------------------	---------

Packaging Features

Packaging Quantity	144
Packaging Method	Box



Other

Serviceable	Yes
-------------	-----

Product Compliance

[For compliance documentation, visit the product page on TE.com>](#)

EU RoHS Directive 2011/65/EU	Compliant
EU ELV Directive 2000/53/EC	Compliant
China RoHS 2 Directive MIIT Order No 32, 2016	No Restricted Materials Above Threshold
EU REACH Regulation (EC) No. 1907/2006	Current ECHA Candidate List: JUNE 2023 (235) Candidate List Declared Against: JUNE 2023 (235) Does not contain REACH SVHC
Halogen Content	Low Halogen - Br, Cl, F, I < 900 ppm per homogenous material. Also BFR/CFR/PVC Free
Solder Process Capability	Not applicable for solder process capability

Product Compliance Disclaimer

This information is provided based on reasonable inquiry of our suppliers and represents our current actual knowledge based on the information they provided. This information is subject to change. The part numbers that TE has identified as EU RoHS compliant have a maximum concentration of 0.1% by weight in homogenous materials for lead, hexavalent chromium, mercury, PBB, PBDE, DBP, BBP, DEHP, DIBP, and 0.01% for cadmium, or qualify for an exemption to these limits as defined in the Annexes of Directive 2011/65/EU (RoHS2). Finished electrical and electronic equipment products will be CE marked as required by Directive 2011/65/EU. Components may not be CE marked. Additionally, the part numbers that TE has identified as EU ELV compliant have a maximum concentration of 0.1% by weight in homogenous materials for lead, hexavalent chromium, and mercury, and 0.01% for cadmium, or qualify for an exemption to these limits as defined in the Annexes of Directive 2000/53/EC (ELV). Regarding the REACH Regulation, the information TE provides on SVHC in articles for this part number is based on the latest European Chemicals Agency (ECHA) 'Guidance on requirements for substances in articles' posted at this URL: <https://echa.europa.eu/guidance-documents/guidance-on-reach>

Compatible Parts



Also in the Series | [Junior Power Timer](#)



Automotive Connector Caps & Covers (5)

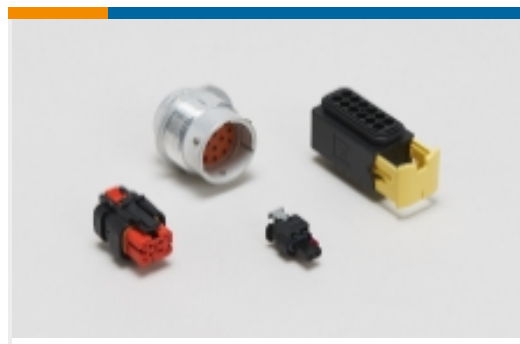

Automotive Housings(252)

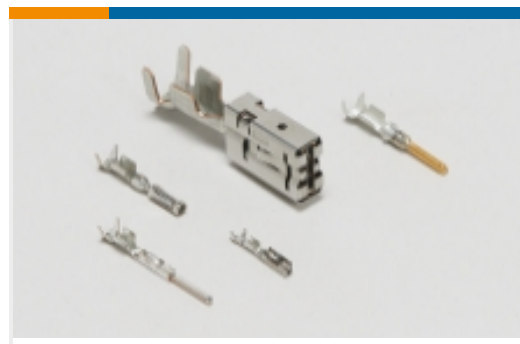

Automotive Terminals(86)



Busbars & Terminals(1)



Connector Seals & Cavity Plugs(10)



Insertion & Extraction Tools(8)



Module Components(6)



Other Automotive Connector Accessories(1)

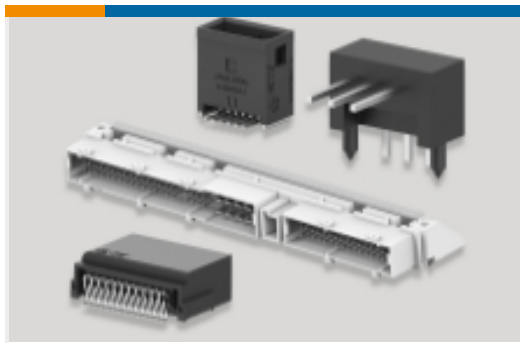

PCB Headers & Receptacles(1)

Customers Also Bought



TE Part #1624163-2
23E 470KB 6.35X50FL B7 CAT

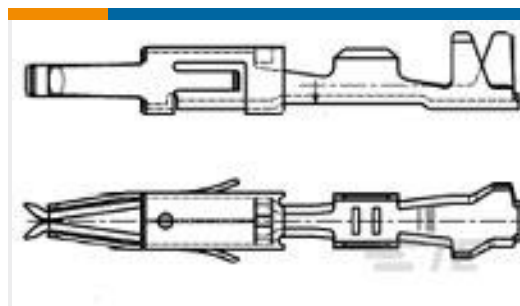

TE Part #968052-1
MT3 REC 1.6 Contact SRC Sn

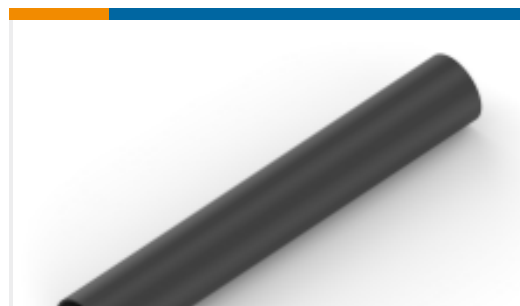

TE Part #NB10746001
ATUM-32/8-0-85MM



TE Part #1418984-1
MICRO TIMER 3 REC.HSG.16POS.

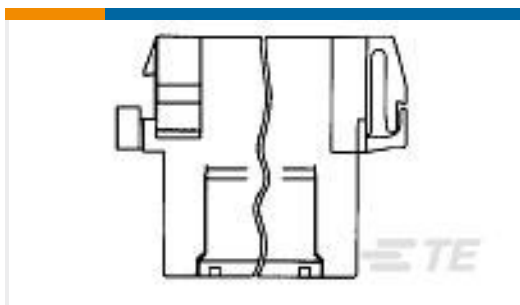

TE Part #1-929505-2
TAB HSG .110 (2.8 MM) HSG TAB



TE Part #955-181-007
CGNW 702659 SF S/FME/SMB/SMA/0.25



TE Part #284436-1
COVER FOR 40 POS. FEMALE HSG



TE Part #284259-1
BLANKING DEVICE ASS'Y X EMPTY

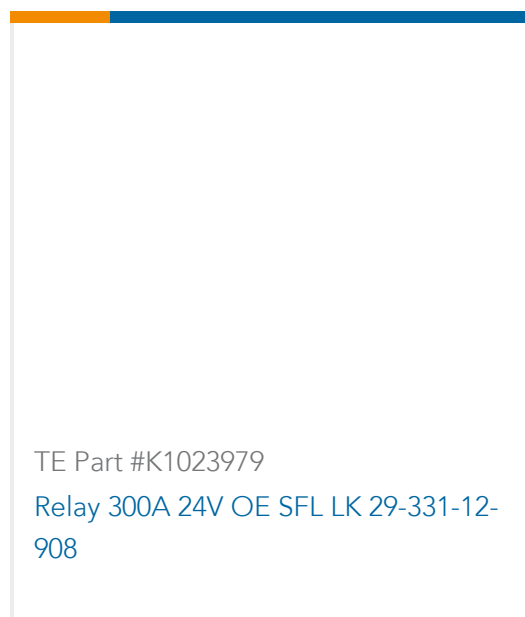

Documents

Product Drawings

[FRAME FOR MICRO TIMER 3 REC.HSG. 16 POS](#)

English

CAD Files

Customer View Model

[ENG_CVM_CVM_1418985-2_C.2d_dxf.zip](#)

English

[3D PDF](#)

3D

Customer View Model

[ENG_CVM_CVM_1418985-2_C.3d_igs.zip](#)

English

Customer View Model

[ENG_CVM_CVM_1418985-2_C.3d_stp.zip](#)

English

By downloading the CAD file I accept and agree to the [Terms and Conditions](#) of use.

Product Specifications

[Micro Timer 3](#)

English

[Product Specification](#)

English