

1418884-1 ✓ ACTIVE

AMP | AMP MCP Connector System

TE Internal #: 1418884-1

Automotive Terminals, Receptacle, Mating Tab Width 1.5 mm [.059 in], Tab Thickness .6 mm [.024 in], 17 – 15 AWG Wire Size, AMP MCP Connector System

[View on TE.com >](#)



Terminals & Splices > Automotive Terminals > AMP MCP, RECEPTACLE AND TAB



Terminal Type: **Receptacle**

Mating Tab Width: 1.5 mm [.059 in]

Mating Tab Thickness: .6 mm [.024 in]

Terminal Transmits: 0 – 24 A (Low Power)

Wire Size: 17 – 15 AWG

[All AMP MCP, RECEPTACLE AND TAB \(129\)](#)

## Features

### Product Type Features

Receptacle Style	180°
Sealable	Yes
Primary Locking Feature	Locking Lance

### Body Features

Terminal Seal Type	Single Wire Seal (SWS)
--------------------	------------------------

### Contact Features

Contact Size	1.5K
Contact Fabrication	Stamped & Formed
Wire Contact Termination Area Plating Material	Tin
Typical Current Rating	13 A
Crimp Type	F-Crimp
Terminal Type	Receptacle
Mating Tab Width	1.5 mm [.059 in]
Mating Tab Thickness	.6 mm [.024 in]
Interface Plating	Tin (Sn)

### Termination Features

Termination Method to Wire & Cable	Crimp
------------------------------------	-------



Product Terminates To	Wire
-----------------------	------

### Dimensions

Compatible Insulation Diameter Range	1.9 – 2.4 mm [.074 – .094 in]
Wire Size	1 – 1.5 mm <sup>2</sup>
Wire Size Search	15 AWG, 16 AWG, 17 AWG

### Usage Conditions

Insulation Option	Uninsulated
Operating Temperature (Max)	80 °C, 85 °C, 90 °C, 100 °C, 105 °C, 110 °C, 120 °C, 125 °C, 130 °C [176 °F][185 °F][194 °F][212 °F][221 °F][230 °F][248 °F][257 °F][266 °F]
Operating Temperature Range	-40 – 130 °C [-40 – 266 °F]

### Operation/Application

Conforms to KOMAX Automatic Component Insertion Guideline	Yes, per Version 5.0 (March 2018)
Compatible With Wire Base Material	Copper

### Industry Standards

Agency/Standard	LV214
-----------------	-------

### Packaging Features

Packaging Quantity	4500
Packaging Method	Reel

### Other

Terminal Transmits	0 – 24 A (Low Power)
--------------------	----------------------

### Product Compliance

[For compliance documentation, visit the product page on TE.com>](#)

EU RoHS Directive 2011/65/EU	Compliant
EU ELV Directive 2000/53/EC	Compliant
China RoHS 2 Directive MIIT Order No 32, 2016	No Restricted Materials Above Threshold
EU REACH Regulation (EC) No. 1907/2006	Current ECHA Candidate List: JUNE 2023 (235) Candidate List Declared Against: JUNE 2023 (235) Does not contain REACH SVHC
Halogen Content	Low Halogen - Br, Cl, F, I < 900 ppm per homogenous material. Also BFR/CFR/PVC



Free

Solder Process Capability

Not applicable for solder process capability

Product Compliance Disclaimer

This information is provided based on reasonable inquiry of our suppliers and represents our current actual knowledge based on the information they provided. This information is subject to change. The part numbers that TE has identified as EU RoHS compliant have a maximum concentration of 0.1% by weight in homogenous materials for lead, hexavalent chromium, mercury, PBB, PBDE, DBP, BBP, DEHP, DIBP, and 0.01% for cadmium, or qualify for an exemption to these limits as defined in the Annexes of Directive 2011/65/EU (RoHS2). Finished electrical and electronic equipment products will be CE marked as required by Directive 2011/65/EU. Components may not be CE marked. Additionally, the part numbers that TE has identified as EU ELV compliant have a maximum concentration of 0.1% by weight in homogenous materials for lead, hexavalent chromium, and mercury, and 0.01% for cadmium, or qualify for an exemption to these limits as defined in the Annexes of Directive 2000/53/EC (ELV). Regarding the REACH Regulation, the information TE provides on SVHC in articles for this part number is based on the latest European Chemicals Agency (ECHA) 'Guidance on requirements for substances in articles' posted at this URL: <https://echa.europa.eu/guidance-documents/guidance-on-reach>

### Compatible Parts



TE Part # CAT-L489-CH8172  
LEAVYSEAL Housings



TE Part # CAT-H3399-CH8172  
Heavy Duty Sealed Connector Series Housings



TE Part # 1-1579007-1  
EXTRACTION TOOL



TE Part # 1-2293551-1  
62POS, MIXED, REC HSG, ASSY, SLD



TE Part # 2305570-1  
Strip Terminal Cutter-Side Feed-No Crimp



TE Part # 2306960-1  
3POS, AMP MCP 1.5K, REC HSG ASSY, SLD, COD A



TE Part # 3-2112231-2  
46POS, AMP MCP1.5K, REC HSG, ASSY



TE Part # CAT-AM705-CH8172  
AMP MCP, SEALED CONNECTOR HOUSING



TE Part # 1-1823440-1  
22POS, MIXED, REC HSG, ASSY, SEALED



TE Part # 2-2293551-1  
62POS, MIXED, REC HSG, ASSY, SLD



TE Part # 2063677-1  
SDE MCP1.5 1.5mm2 ASSY



TE Part # 2063677-2  
SDE MCP1.5 1.5mm2 DIE SET



TE Part # 2151424-1  
OCEAN\_2.0\_Applicator-S-080F1350



TE Part # 2151424-2  
OCEAN\_2.0\_Applicator-S-080F1350



TE Part # 2299987-1  
65W PLUG ASSEMBLY



TE Part # 2299987-3  
65W PLUG ASSEMBLY



TE Part # 2299987-4  
65W PLUG ASSEMBLY



TE Part # 3-2112231-1  
46POS,AMP MCP1.5K,REC HSG,ASSY



TE Part # 3-2112231-3  
46POS,AMP MCP1.5K,REC HSG,ASSY



TE Part # 3-2293551-1  
62POS,MIXED,REC HSG,ASSY,SLD

## Also in the Series | AMP MCP Connector System

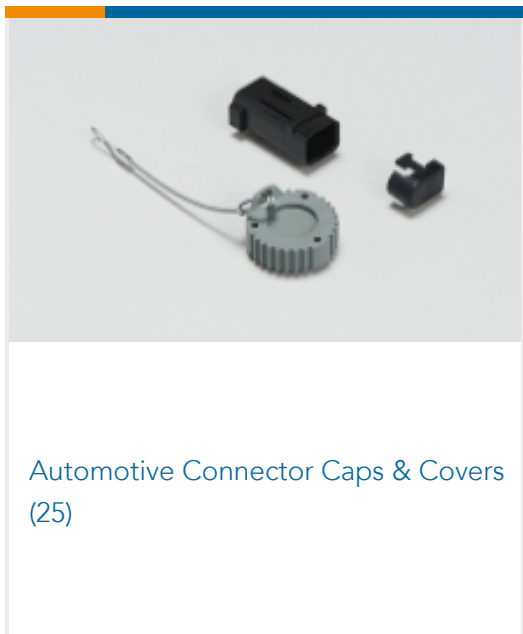

Automotive Connector Caps & Covers  
(25)

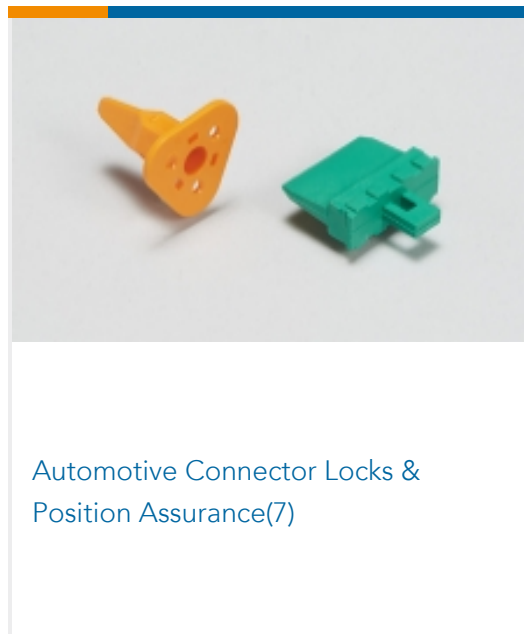

Automotive Connector Locks &  
Position Assurance(7)

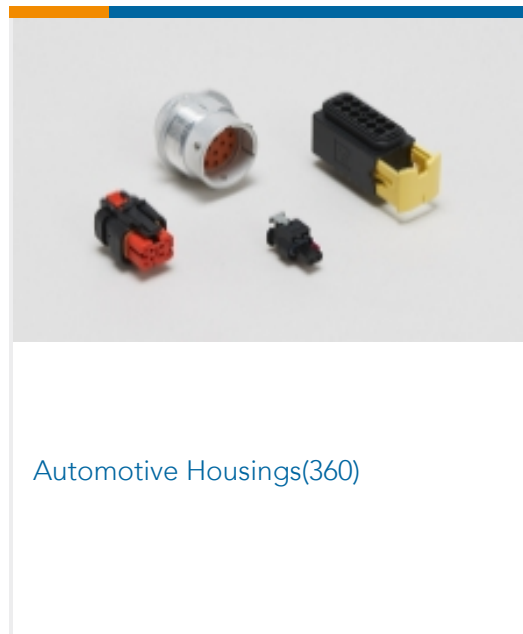

Automotive Housings(360)

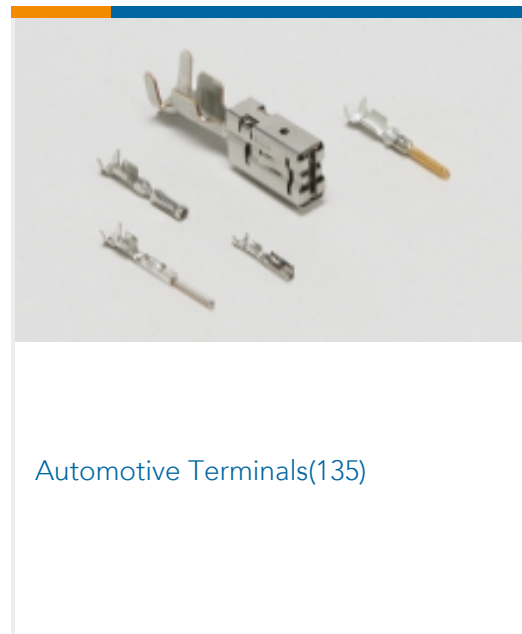

Automotive Terminals(135)

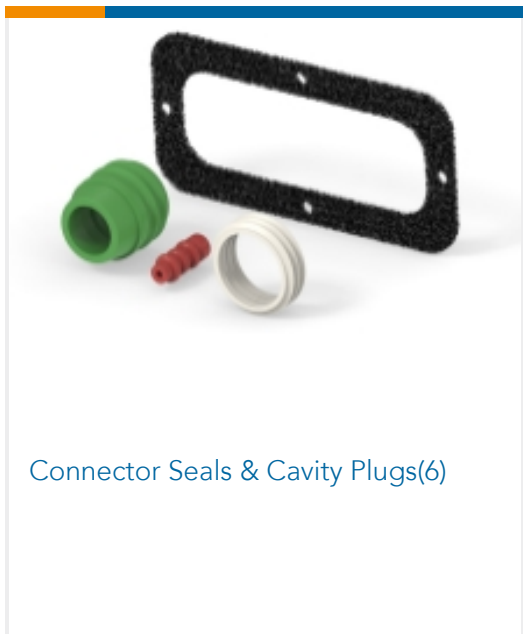

Connector Seals & Cavity Plugs(6)

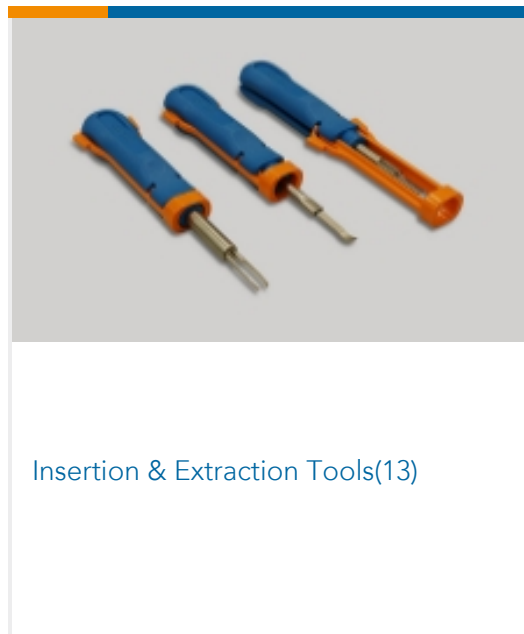

Insertion & Extraction Tools(13)

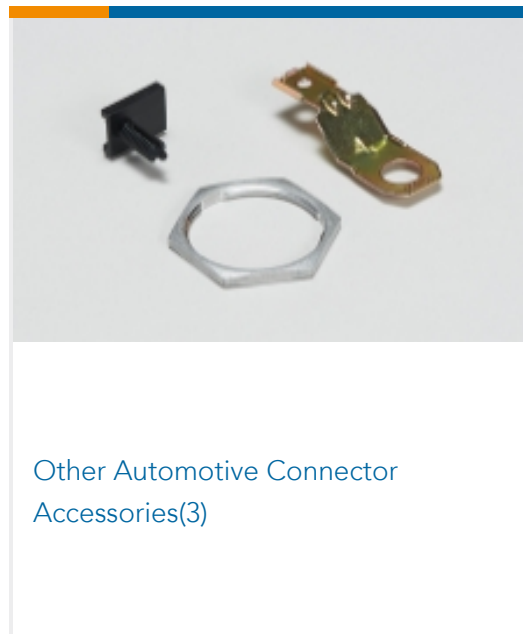

Other Automotive Connector  
Accessories(3)



PCB Headers & Receptacles(30)

## Customers Also Bought



TE Part #963530-1  
EINZELLEITERDICHTNG



TE Part #1703997-1  
COVER,90,DEGREE



TE Part #1-1452228-9  
TAB HEADER 92POS.



TE Part #929952-1  
MT1 REC 1.6 Contact SRC Sn



TE Part #1241380-1  
AMP MCP 1.5K, CONTACT, SWS



TE Part #3-1564414-1  
12POS,TAB 1.6X0.6,TAB HSG,ASSY



TE Part #AS012-35PA  
RECEPT.2 HOLE MNT.TYPE 0



TE Part #AS214-19PN  
RECEPT.BOX MNTG.TYPE 2

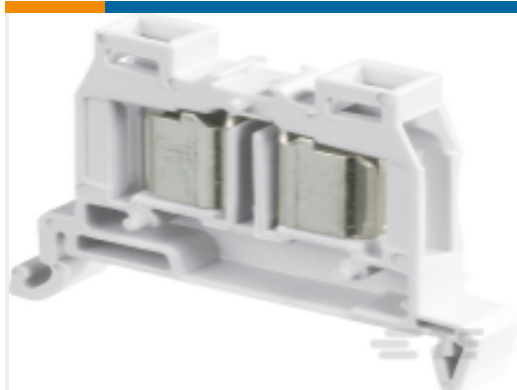

TE Part #1SNA299501R0300  
DS2.5/8.ADO



TE Part #YASX202-06PN-HE-R0  
RECEPT. ASX 6 WAY TYPE 2.PCB.

## Documents

### Product Drawings

[AMP MCP 1.5K, CONTACT, SWS](#)

English

[AMP MCP 1.5K, CONTACT, SWS](#)

English

### CAD Files

[3D PDF](#)

3D

Customer View Model

[ENG\\_CVM\\_CVM\\_1418884-1\\_B\\_c-1418884-1-b.2d\\_dxf.zip](#)

English

Customer View Model

[ENG\\_CVM\\_CVM\\_1418884-1\\_B\\_c-1418884-1-b.3d\\_igs.zip](#)

English

Customer View Model

[ENG\\_CVM\\_CVM\\_1418884-1\\_B\\_c-1418884-1-b.3d\\_stp.zip](#)

English

By downloading the CAD file I accept and agree to the [Terms and Conditions](#) of use.

### Datasheets & Catalog Pages

[HDSCS Catalog](#)

English

[CONNECTOR SELECTOR](#)

English

### Product Specifications



[Application Specification](#)

German

[Application Specification](#)

English