



FASTON | FASTON 250

TE Internal #: 141879-2

PCB Terminals, Tab, Mating Tab Width .25 in [6.35 mm], PCB Hole Diameter 4.1 mm [.16 – .16 in], Through Hole - Screw, Tin Plating, Brass, FASTON 250

[View on TE.com >](#)

Terminals & Splices > PCB Terminals

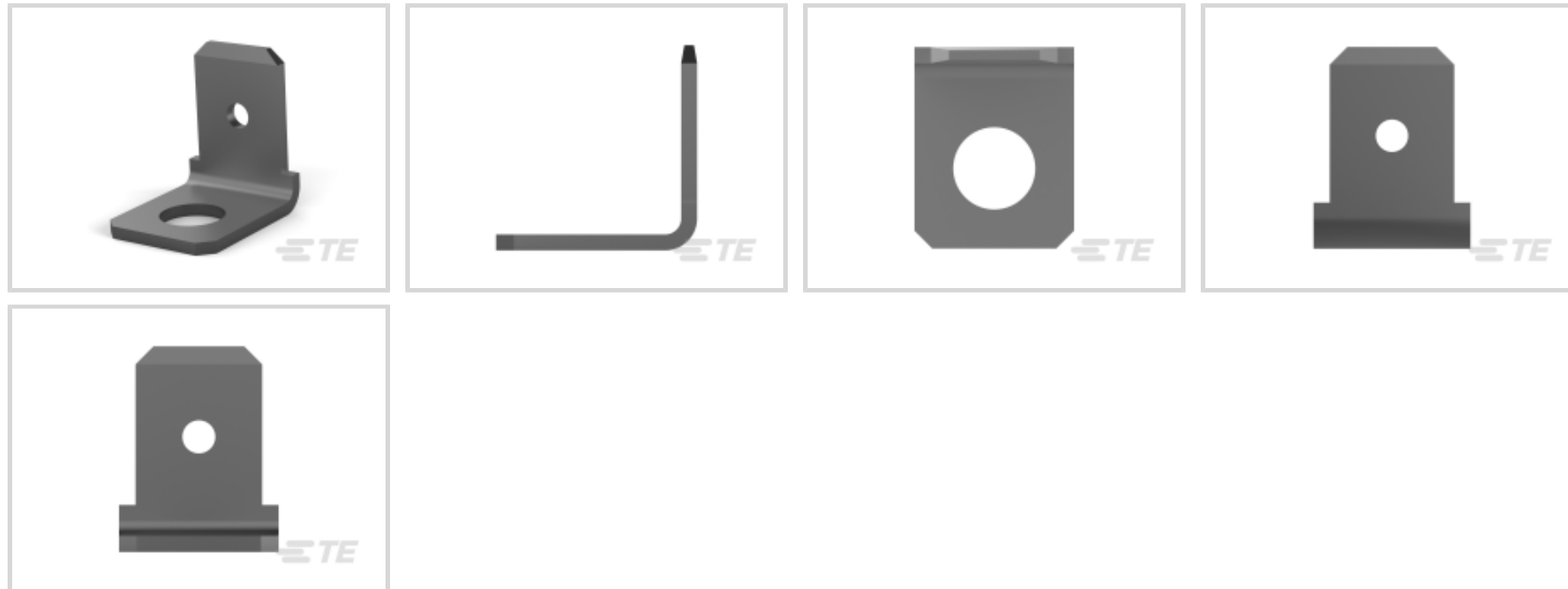

PCB Terminal Type: **Tab**

Mating Tab Width: **6.35 mm [.25 in]**

Mating Tab Thickness: **.81 mm [.032 in]**

PCB Hole Diameter: **4.1 mm [.16 – .16 in]**

Termination Method to Printed Circuit Board: **Through Hole - Screw**

Features

Product Type Features

Terminal Features	Stud Hole
-------------------	-----------

Contact Features

PCB Contact Termination Area Plating Material Thickness	2.03 μm[80 μin]
Contact Mating Area Plating Material Thickness	2.03 μm[80 μin]
PCB Terminal Type	Tab
Mating Tab Width	6.35 mm[.25 in]
Mating Tab Thickness	.81 mm[.032 in]
Terminal Plating Material	Tin
Contact Underplating Material	Brass
Terminal Size	6.35
Terminal Orientation	Right Angle

Termination Features

Termination Method to Printed Circuit Board	Through Hole - Screw
Product Terminates To	Printed Circuit Board



Dimensions

Terminal Material Thickness	.81 mm[.032 in]
Stud Diameter	4.1 mm[.161 in]
PCB Hole Diameter	4.1 mm[.16 – 16 in]

Usage Conditions

Insulation Option	Uninsulated
Operating Temperature Range	-30 – 110 °C[-22 – 230 °F]

Packaging Features

Packaging Quantity	10000
Packaging Method	Box

Product Compliance

[For compliance documentation, visit the product page on TE.com>](#)

EU RoHS Directive 2011/65/EU	Compliant
EU ELV Directive 2000/53/EC	Compliant
China RoHS 2 Directive MIIT Order No 32, 2016	No Restricted Materials Above Threshold
EU REACH Regulation (EC) No. 1907/2006	Current ECHA Candidate List: JUNE 2023 (235) Candidate List Declared Against: JUNE 2023 (235) Does not contain REACH SVHC
Halogen Content	Low Halogen - Br, Cl, F, I < 900 ppm per homogenous material. Also BFR/CFR/PVC Free
Solder Process Capability	Not applicable for solder process capability

Product Compliance Disclaimer

This information is provided based on reasonable inquiry of our suppliers and represents our current actual knowledge based on the information they provided. This information is subject to change. The part numbers that TE has identified as EU RoHS compliant have a maximum concentration of 0.1% by weight in homogenous materials for lead, hexavalent chromium, mercury, PBB, PBDE, DBP, BBP, DEHP, DIBP, and 0.01% for cadmium, or qualify for an exemption to these limits as defined in the Annexes of Directive 2011/65/EU (RoHS2). Finished electrical and electronic equipment products will be CE marked as required by Directive 2011/65/EU. Components may not be CE marked. Additionally, the part numbers that TE has identified as EU ELV compliant have a maximum concentration of 0.1% by weight in homogenous materials for lead, hexavalent chromium, and mercury, and 0.01% for cadmium, or qualify for an exemption to these limits as defined in the Annexes of Directive 2000/53/EC (ELV). Regarding the REACH Regulation, the information TE provides on SVHC in articles for this part number is based on the latest European Chemicals Agency (ECHA) 'Guidance on requirements for substances in articles' posted at this URL: <https://echa.europa.eu/guidance-documents/guidance-on-reach>

Compatible Parts



Also in the Series | **FASTON 250**

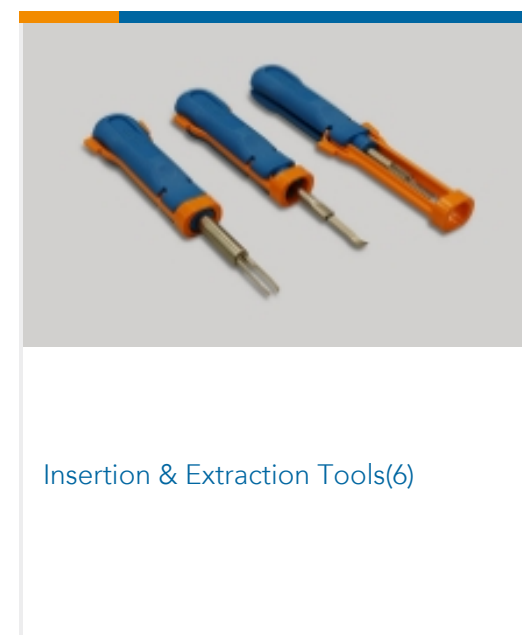
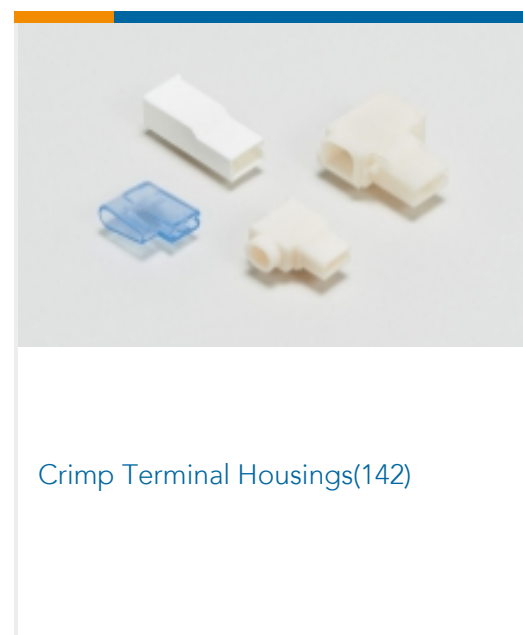
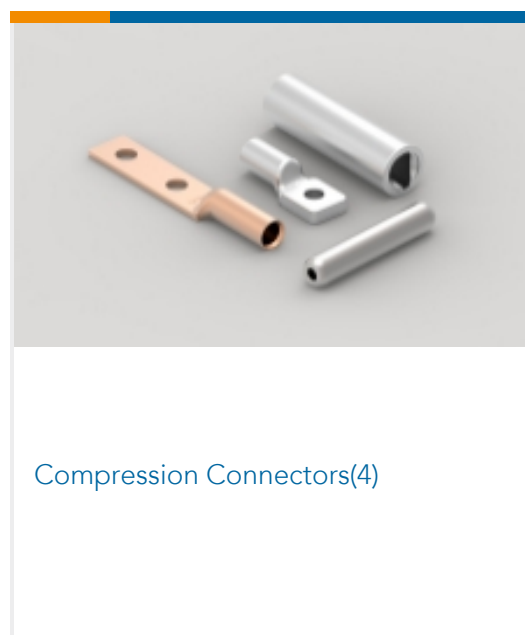



PCB Terminals(135)



Quick Disconnects(445)



Splices(4)

Customers Also Bought

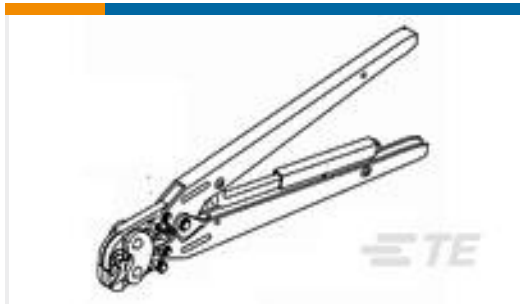

TE Part #47386-4
DAHT PG PIDG 26-16 ASSY

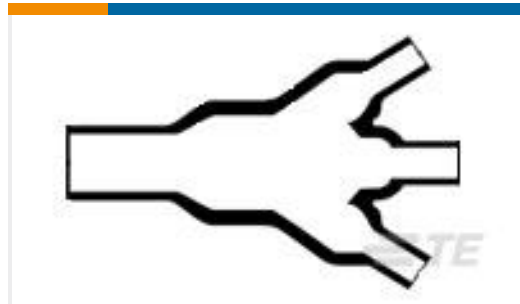

TE Part #924869-000
462A011-25/86-0



TE Part #5-1625890-2
2W SM M/OX 5% 47K



TE Part #130522
PIDG SPADE



TE Part #2213766-3
AV19 SPM 5A POWER LED WHITE 24V

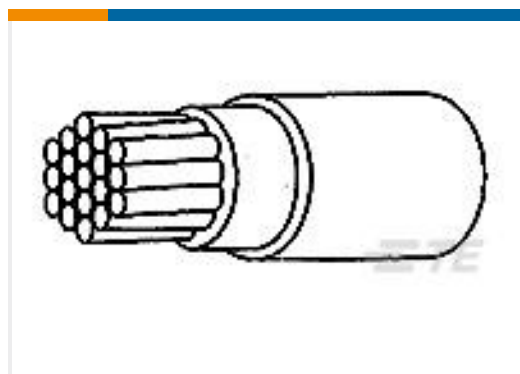

TE Part #4478853001
FLT0111-0.35-6



TE Part #3-521383-2
ASSY DIN VERT RAST5 HEADER02-E



TE Part #5-1768034-7
LEB-A4PM-X



TE Part #4-1102700-5
EMV-K.3/4.STO.1.11.G

Documents

Product Drawings
[250 FASTON,TAB,TPBR](#)

CAD Files

[3D PDF](#)

[3D](#)

Customer View Model

[ENG_CVM_CVM_141879-2_L.2d_dxf.zip](#)

English



Customer View Model

[ENG_CVM_CVM_141879-2_L.3d_igs.zip](#)

English

Customer View Model

[ENG_CVM_CVM_141879-2_L.3d_stp.zip](#)

English

By downloading the CAD file I accept and agree to the [Terms and Conditions](#) of use.

Product Environmental Compliance

[MD_141879-2_062920142321_dmtec](#)

English

[MD_141879-2_062920142321_dmtec](#)

English