

1418762-1 ✓ ACTIVE

AMP | MCON Interconnection System

TE Internal #: 1418762-1

Automotive Terminals, Tab, Mating Tab Width 1.2 mm [.047 in], Tab Thickness .6 mm [.024 in], 17 – 15 AWG Wire Size, MCON Interconnection System

[View on TE.com >](#)



Terminals & Splices > Automotive Terminals > MCON Receptacle and Tab



Terminal Type: **Tab**

Mating Tab Width: **1.2 mm [.047 in]**

Mating Tab Thickness: **.6 mm [.024 in]**

Terminal Transmits: **0 – 24 A (Low Power)**

Wire Size: **17 – 15 AWG**

[All MCON Receptacle and Tab \(103\)](#)

## Features

### Product Type Features

Receptacle Style	180°
Sealable	No
Primary Locking Feature	Locking Lance

### Contact Features

Contact Size	1.15mm
Contact Fabrication	Stamped & Formed
Wire Contact Termination Area Plating Material	Tin
Crimp Type	F-Crimp
Terminal Type	Tab
Mating Tab Width	1.2 mm[.047 in]
Mating Tab Thickness	.6 mm[.024 in]
Interface Plating	Tin (Sn)

### Termination Features

Termination Method to Wire & Cable	Crimp
Product Terminates To	Wire

### Dimensions



Compatible Insulation Diameter Range	1.9 – 2.4 mm [.075 – .094 in]
Wire Size	1 – 1.5 mm <sup>2</sup>
Wire Size Search	15 AWG, 16 AWG, 17 AWG

### Usage Conditions

Insulation Option	Uninsulated
Operating Temperature (Max)	80 °C, 85 °C, 90 °C, 100 °C, 105 °C, 110 °C, 120 °C, 125 °C, 130 °C [176 °F][185 °F][194 °F][212 °F][221 °F][230 °F][248 °F][257 °F][266 °F]
Operating Temperature Range	-40 – 130 °C [-40 – 266 °F]

### Operation/Application

Compatible With Wire Base Material	Copper
------------------------------------	--------

### Industry Standards

Agency/Standard	LV214
-----------------	-------

### Packaging Features

Packaging Quantity	7000
Packaging Method	Reel

### Other

Terminal Transmits	0 – 24 A (Low Power)
--------------------	----------------------

## Product Compliance

[For compliance documentation, visit the product page on TE.com>](#)

EU RoHS Directive 2011/65/EU	Compliant
EU ELV Directive 2000/53/EC	Compliant
China RoHS 2 Directive MIIT Order No 32, 2016	No Restricted Materials Above Threshold
EU REACH Regulation (EC) No. 1907/2006	Current ECHA Candidate List: JUNE 2023 (235) Candidate List Declared Against: JUNE 2023 (235) Does not contain REACH SVHC
Halogen Content	Low Halogen - Br, Cl, F, I < 900 ppm per homogenous material. Also BFR/CFR/PVC Free
Solder Process Capability	Not applicable for solder process capability

Product Compliance Disclaimer



This information is provided based on reasonable inquiry of our suppliers and represents our current actual knowledge based on the information they provided. This information is subject to change. The part numbers that TE has identified as EU RoHS compliant have a maximum concentration of 0.1% by weight in homogenous materials for lead, hexavalent chromium, mercury, PBB, PBDE, DBP, BBP, DEHP, DIBP, and 0.01% for cadmium, or qualify for an exemption to these limits as defined in the Annexes of Directive 2011/65/EU (RoHS2). Finished electrical and electronic equipment products will be CE marked as required by Directive 2011/65/EU. Components may not be CE marked. Additionally, the part numbers that TE has identified as EU ELV compliant have a maximum concentration of 0.1% by weight in homogenous materials for lead, hexavalent chromium, and mercury, and 0.01% for cadmium, or qualify for an exemption to these limits as defined in the Annexes of Directive 2000/53/EC (ELV). Regarding the REACH Regulation, the information TE provides on SVHC in articles for this part number is based on the latest European Chemicals Agency (ECHA) 'Guidance on requirements for substances in articles' posted at this URL: <https://echa.europa.eu/guidance-documents/guidance-on-reach>

## Compatible Parts



TE Part # 5-1579007-3  
EXTRACTION TOOL



TE Part # 2305570-1  
Strip Terminal Cutter-Side Feed-No Crimp



TE Part # 7-1452659-1  
MCON 1.2 LL REC SRC SN



TE Part # 1-2236046-0  
32W, MIXED, MALE CONN., CLIP2, COD A, CPA



TE Part # 1-2236046-1  
32W, MIXED, MALE CONN., CLIP2, COD B, CPA



TE Part # 1801735-1  
18W HYBRID UNSEALED RCPT HSG ASSY BLACK



TE Part # 1801735-3  
18W HYBRID UNSEALED RCPT HSG ASSY BLUE



TE Part # 1801735-4  
18W HYBRID UNSEALED RCPT HSG ASSY BROWN



TE Part # 2138414-1  
50P HYBRID UNSEALED, MALE CAP



TE Part # 2151479-1  
OCEAN\_2.0\_APPLICATOR-S-070F090BX



TE Part # 2151479-2  
OCEAN\_2.0\_APPLICATOR-S-070F090BX



TE Part # 2236046-7  
32POS, MIXED, MALE CONN., CLIP2, COD A



TE Part # 2236046-8  
32POS, MIXED, MALE CONN., CLIP2, COD B



TE Part # 2366066-1  
48POS, MCON 1.2, TAB HSG ASSY, UNSLD, COD A



TE Part # 2366066-2  
48POS, MCON 1.2, TAB HSG ASSY, UNSLD, COD B



TE Part # 2366066-3  
48POS, MCON 1.2, TAB HSG ASSY, UNSLD, COD C



TE Part # 2366066-4  
48POS,MCON 1.2,TAB HSG ASSY,  
UNSLD,COD D



TE Part # 2382874-1  
16POS,1.2X0.63,TAB HSG ASSY,  
UNSLD,COD A



TE Part # 2382874-2  
16POS,1.2X0.63,TAB HSG ASSY,  
UNSLD,COD A



TE Part # 2382874-3  
16POS,1.2X0.63,TAB HSG ASSY,  
UNSLD,COD A

## Also in the Series | MCON Interconnection System



Automotive Connector Caps & Covers  
(24)

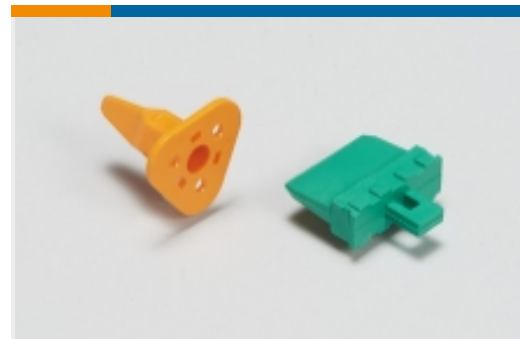

Automotive Connector Locks &  
Position Assurance(11)



Automotive Housings(320)

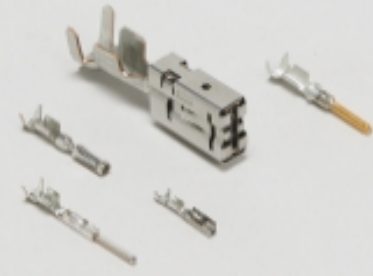

Automotive Terminals(122)



Connector Seals & Cavity Plugs(5)



Insertion & Extraction Tools(31)



Other Automotive Connector  
Accessories(7)



PCB Headers & Receptacles(2)

## Customers Also Bought



TE Part #2-968326-1  
MQS, CONNECTOR HOUSING



TE Part #8-1625963-6  
HSA5 330R 5%



TE Part #52951-1  
PG SPR SPD 22-16COM22-18MIL 10



TE Part #7-1452659-1  
MCON Receptacle and Tab

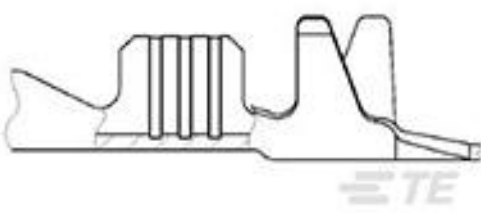

TE Part #2141892-2  
JPT A REC 2.8 Contact SRC Sn



TE Part #2236060-1  
COVER,ASSY

TE Part #2112675-2

TE Part #2112675-3



## Documents

### Product Drawings

[MCON 1.2 LL TAB STC SN](#)

English

---

### CAD Files

Customer View Model

[ENG\\_CVM\\_CVM\\_1418762-1\\_A.2d\\_dxf.zip](#)

English

3D PDF

3D

Customer View Model

[ENG\\_CVM\\_CVM\\_1418762-1\\_A.3d\\_igs.zip](#)

English

Customer View Model

[ENG\\_CVM\\_CVM\\_1418762-1\\_A.3d\\_stp.zip](#)

English

By downloading the CAD file I accept and agree to the [Terms and Conditions](#) of use.

---

### Datasheets & Catalog Pages

[MCON Interconnection System](#)

English

---

### Product Specifications

[Application Specification](#)

English

[Application Specification](#)

English