



**PIDG**

TE Internal #: 141456-1

Crimp Wire Pins, Tabs & Ferrules, Shur-Plug Receptacle, 20 – 16 AWG Wire Size, .5 – 1.31 mm<sup>2</sup> Wire Size, 1022 – 2583 CMA Wire Size, Closed, PIDG

[View on TE.com >](#)

Terminals & Splices > Crimp Wire Pins, Tabs & Ferrules > PIDG Shur Plugs



Crimp Wire Terminal Type: **Shur-Plug Receptacle**

Compatible Insulation Diameter Range: **3.3 mm [ .13 in ]**

Wire Size: **1022 – 2583 CMA**

[All PIDG Shur Plugs \(7\)](#)

**Features**

**Product Type Features**

Sealable	No
Wire Insulation Support Retention Type	Insulation Support

**Configuration Features**

Compatible With Wire & Cable Type	Discrete Wire
-----------------------------------	---------------

**Body Features**

Sleeve Material	Copper
Primary Product Color	Red

**Contact Features**

Crimp Wire Terminal Type	Shur-Plug Receptacle
Barrel Type	Closed
Terminal Plating Material	Tin
Terminal Orientation	Straight

**Termination Features**

--	--



Termination Method to Wire & Cable	Crimp
------------------------------------	-------

### Mechanical Attachment

Wire Insulation Support	With
-------------------------	------

### Dimensions

Compatible Insulation Diameter Range	3.3 mm[.13 in]
Wire Size	1022 – 2583 CMA
Terminal Material Thickness	.79 mm[.031 in]
Overall Product Length	25 mm[.983 in]

### Usage Conditions

Insulation Option	Fully Insulated
Operating Temperature Range	105 °C[221 °F]

### Packaging Features

Packaging Quantity	1000
Packaging Method	Box

### Product Compliance

[For compliance documentation, visit the product page on TE.com>](#)

EU RoHS Directive 2011/65/EU	Compliant
EU ELV Directive 2000/53/EC	Compliant
China RoHS 2 Directive MIIT Order No 32, 2016	No Restricted Materials Above Threshold
EU REACH Regulation (EC) No. 1907/2006	Current ECHA Candidate List: JUNE 2023 (235) Candidate List Declared Against: JUNE 2022 (224) Does not contain REACH SVHC
Halogen Content	Low Halogen - Br, Cl, F, I < 900 ppm per homogenous material. Also BFR/CFR/PVC Free
Solder Process Capability	Not applicable for solder process capability

#### Product Compliance Disclaimer

This information is provided based on reasonable inquiry of our suppliers and represents our current actual knowledge based on the information they provided. This information is subject to change. The part numbers that TE has identified as EU RoHS compliant have a maximum concentration of 0.1% by weight in homogenous materials for lead, hexavalent chromium, mercury, PBB, PBDE, DBP, BBP, DEHP, DIBP, and 0.01% for cadmium, or qualify for an exemption to these limits as defined in the Annexes of Directive 2011/65/EU (RoHS2). Finished electrical and electronic equipment products will be CE marked as required by Directive 2011/65/EU. Components may not be CE marked. Additionally, the part numbers that TE has identified as EU ELV compliant have a maximum concentration of 0.1% by weight in homogenous materials for lead, hexavalent chromium, and mercury, and 0.01% for cadmium, or qualify for an exemption to these limits

as defined in the Annexes of Directive 2000/53/EC (ELV). Regarding the REACH Regulation, the information TE provides on SVHC in articles for this part number is based on the latest European Chemicals Agency (ECHA) 'Guidance on requirements for substances in articles' posted at this URL: <https://echa.europa.eu/guidance-documents/guidance-on-reach>

## Compatible Parts



## Also in the Series | PIDG

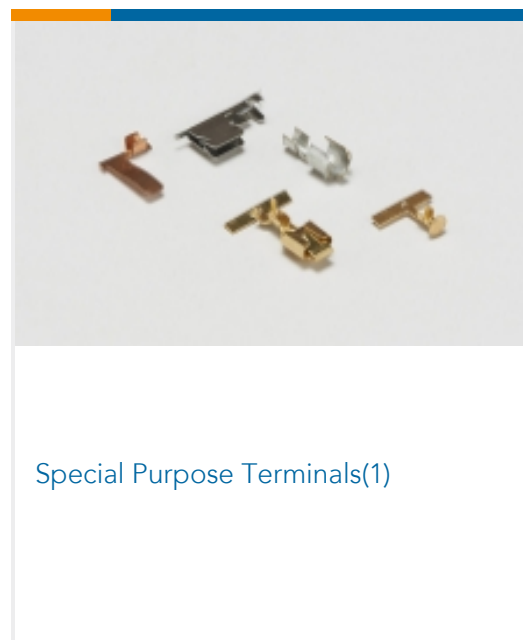
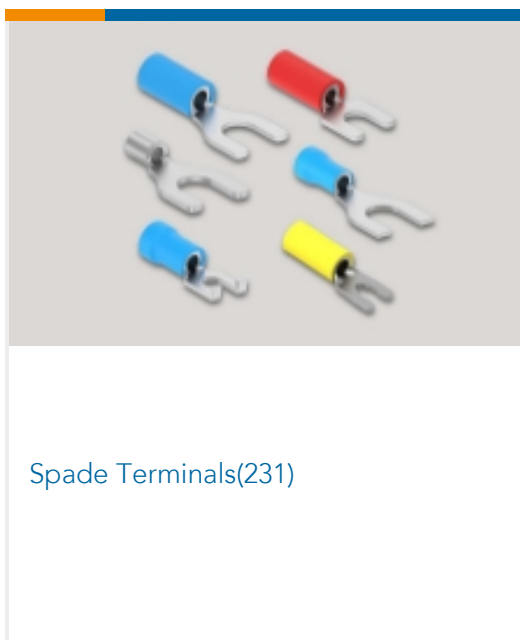
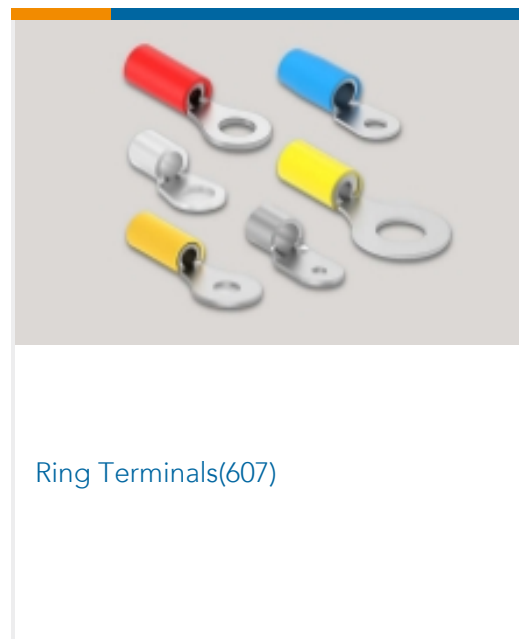
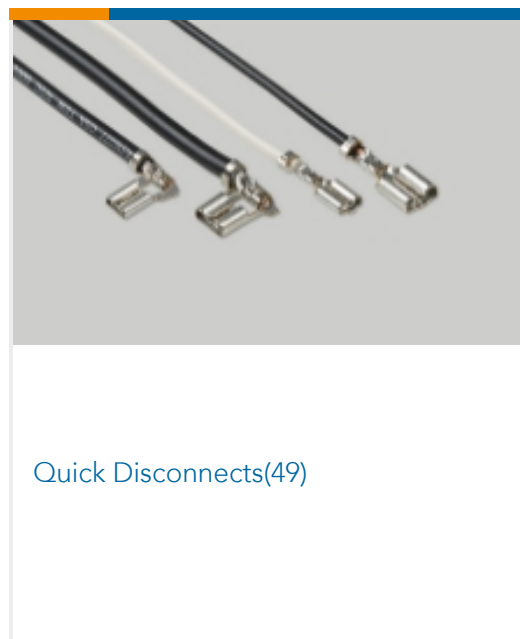
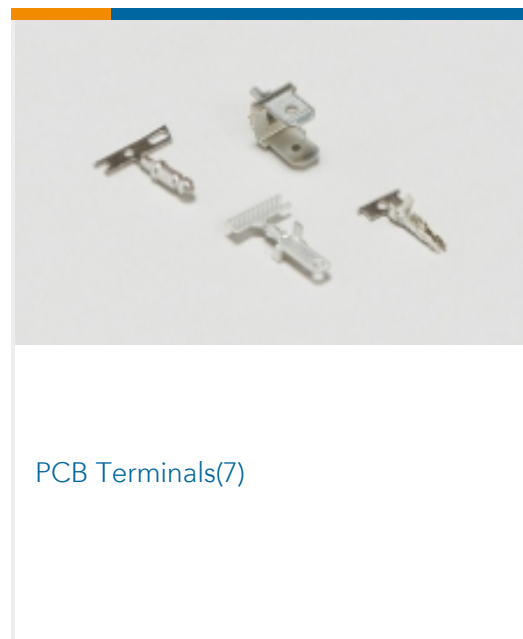
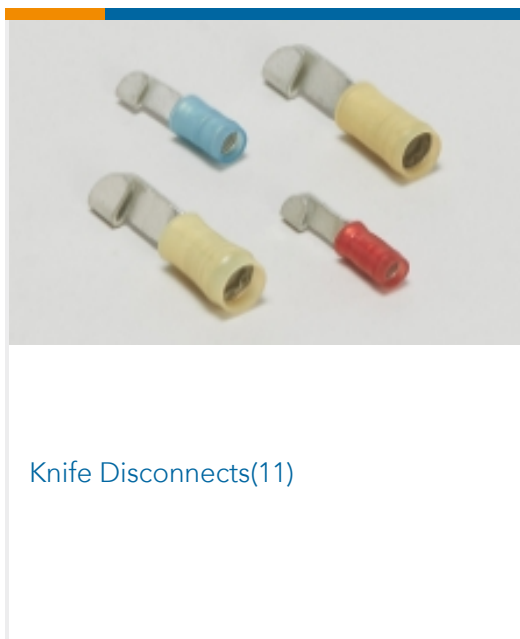
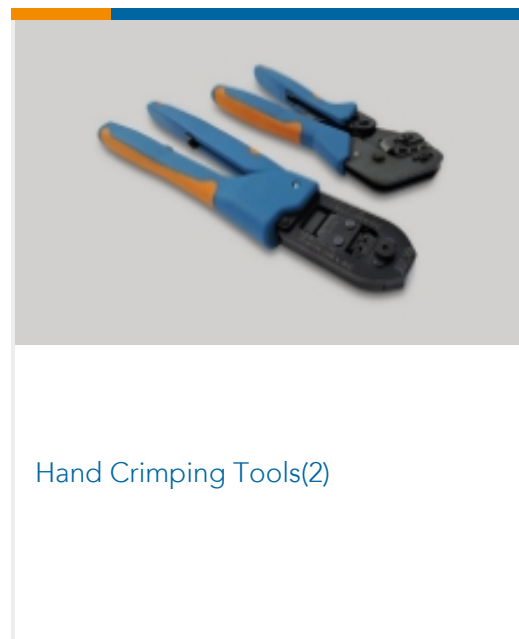
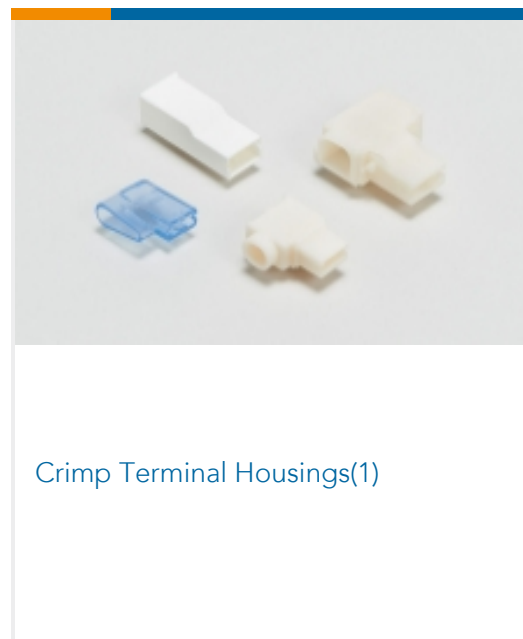
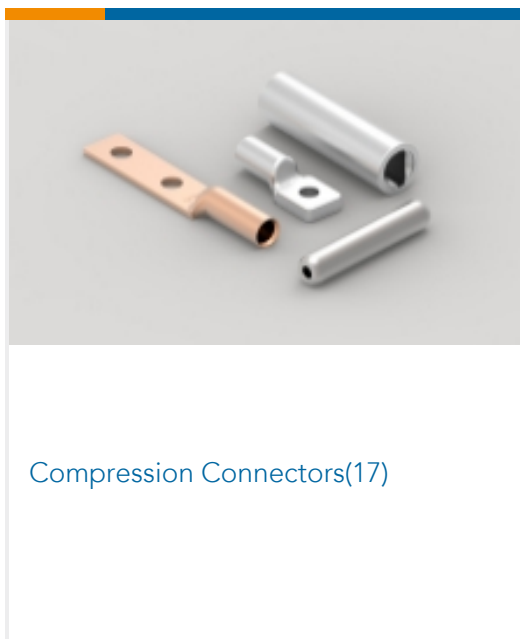

## Customers Also Bought



TE Part #328849  
TERMINAL,PIDG R 16-14 1/2



TE Part #292173-6  
CT BOX HDR H SMT 6P O/TAPE BLA



TE Part #6-160526-2  
FF 250 REC 0.5-1.5MM2 TPPB

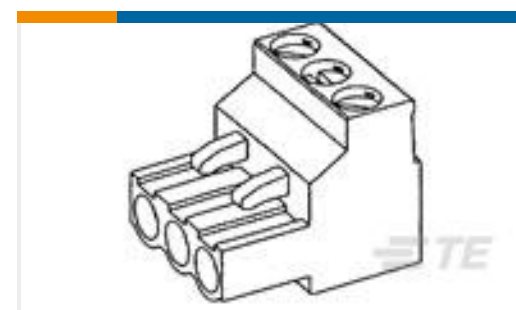

TE Part #282959-3  
TERMI-BLOK PLUG 3P. 7

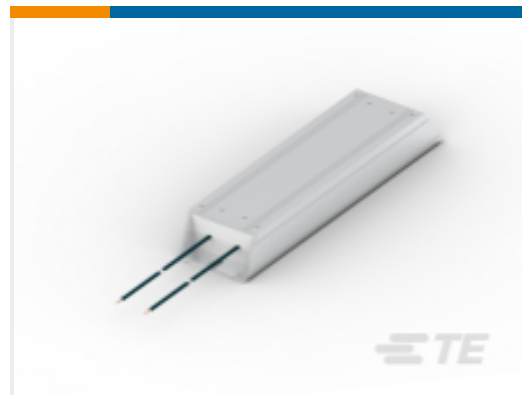

TE Part #2176464-9  
HCH215 300W 220R 5% LEAD

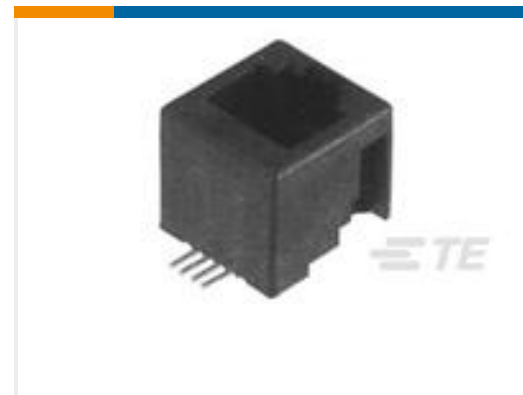

TE Part #2-338086-3  
6P/6C INV MJ, SMT 22" TOP REEL



TE Part #2831433006  
44A0111-20-2L



TE Part #CTJ-3A-04-4021  
RAIL ASSY

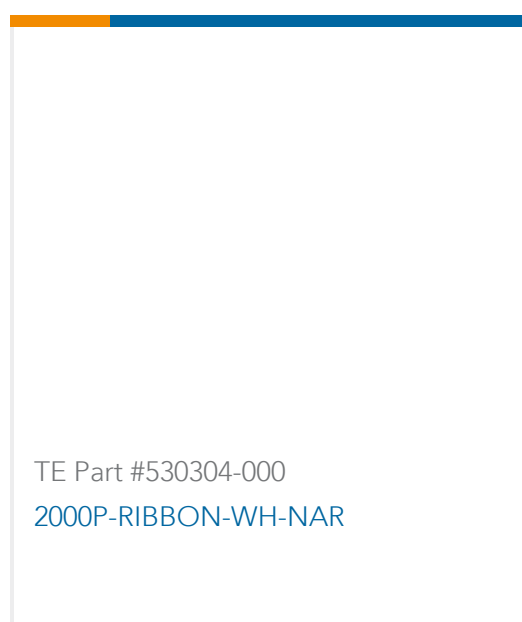

TE Part #530304-000  
2000P-RIBBON-WH-NAR

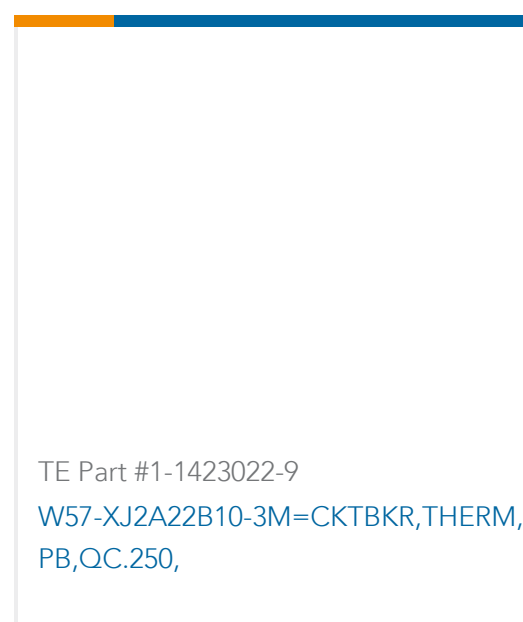

TE Part #1-1423022-9  
W57-XJ2A22B10-3M=CKTBKR,THERM,  
PB,QC.250,

## Documents

### Product Drawings

[SKT ASSY, SHUR,INS, 4 MM DIA, 22-16 AWG](#)

English

### CAD Files

Customer View Model

[ENG\\_CVM\\_CVM\\_141456-1\\_C.2d\\_dxf.zip](#)

English

3D PDF

3D

Customer View Model

[ENG\\_CVM\\_CVM\\_141456-1\\_C.3d\\_igs.zip](#)

English

Customer View Model

[ENG\\_CVM\\_CVM\\_141456-1\\_C.3d\\_stp.zip](#)

English

By downloading the CAD file I accept and agree to the [Terms and Conditions](#) of use.

## Datasheets & Catalog Pages



## PIDG TERMINALS & SPLICES Quick Reference Guide

English