



Relays, Contactors & Switches > Relays > Relay Accessories, Sockets & Clips



Relay Accessory, Socket & Clip Product Type: **Accessory**
 Relay Accessory, Socket & Clip Body Material: **Retaining Clip**
 Relay Accessory, Socket & Clip For Use With: **Socket Mount Relays**
 Relay Accessory Type: **Metal Retaining Clip**

Features

Product Type Features

Relay Accessory, Socket & Clip Product Type	Accessory
Relay Accessory Type	Metal Retaining Clip

Body Features

Relay Accessory, Socket & Clip Body Material	Retaining Clip
--	----------------

Operation/Application

Relay Accessory, Socket & Clip For Use With	Socket Mount Relays
---	---------------------

Product Compliance









[For compliance documentation, visit the product page on TE.com>](#)

EU RoHS Directive 2011/65/EU	Compliant
EU ELV Directive 2000/53/EC	Compliant
China RoHS 2 Directive MIIT Order No 32, 2016	No Restricted Materials Above Threshold
EU REACH Regulation (EC) No. 1907/2006	Current ECHA Candidate List: JUNE 2023 (235) Candidate List Declared Against: JUNE 2022 (224) Does not contain REACH SVHC
Halogen Content	Low Halogen - Br, Cl, F, I < 900 ppm per homogenous material. Also BFR/CFR/PVC Free
Solder Process Capability	Not applicable for solder process capability

Product Compliance Disclaimer

This information is provided based on reasonable inquiry of our suppliers and represents our current actual knowledge based on the information they provided. This information is subject to change. The part numbers that TE has identified as EU RoHS compliant have a maximum concentration of 0.1% by weight in homogenous materials for lead, hexavalent chromium, mercury, PBB, PBDE, DBP, BBP, DEHP, DIBP, and 0.01% for cadmium, or qualify for an exemption to these limits as defined in the Annexes of Directive 2011/65/EU (RoHS2). Finished electrical and electronic equipment products will be CE marked as required by Directive 2011/65/EU. Components may not be CE marked. Additionally, the part numbers that TE has identified as EU ELV compliant have a maximum concentration of 0.1% by weight in homogenous materials for lead, hexavalent chromium, and mercury, and 0.01% for cadmium, or qualify for an exemption to these limits as defined in the Annexes of Directive 2000/53/EC (ELV). Regarding the REACH Regulation, the information TE provides on SVHC in articles for this part number is based on the latest European Chemicals Agency (ECHA) 'Guidance on requirements for substances in articles' posted at this URL: <https://echa.europa.eu/guidance-documents/guidance-on-reach>

Compatible Parts

 <p>TE Part # 7-1415002-1 PT370R24</p>	 <p>TE Part # 5-1415026-1 PT580L24</p>	 <p>TE Part # 9-1419111-0 PT570615</p>	 <p>TE Part # 8-1419111-8 PT570548</p>
 <p>TE Part # 8-1419111-1 PT570048</p>	 <p>TE Part # 1393162-5 PT78603</p>	 <p>TE Part # 8-1419111-0 PT570012</p>	 <p>TE Part # 8-1419132-9 PT580615</p>
 <p>TE Part # 6-1419111-9 PT370730</p>	 <p>TE Part # 1-1393154-7 PT580024</p>	 <p>TE Part # 7-1415001-1 PT570R24</p>	 <p>TE Part # 1-1393154-2 PT570024</p>



Also in the Series | **SCHRACK Accessories Miniature Relay PT**

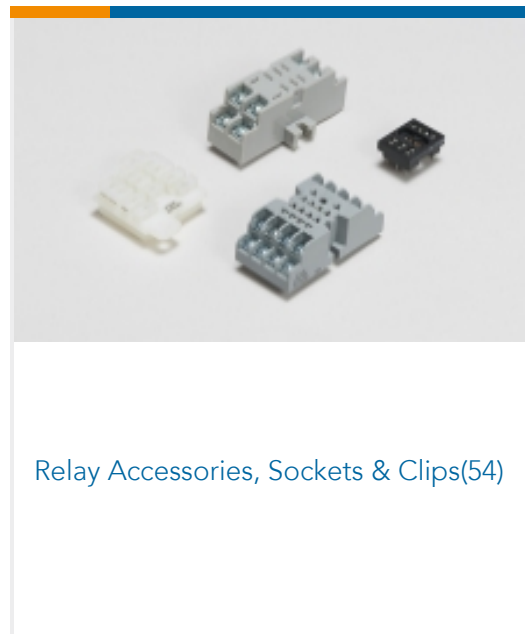

Customers Also Bought

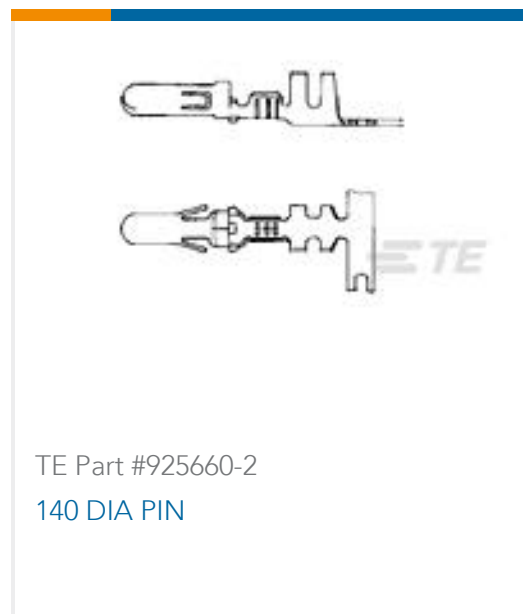
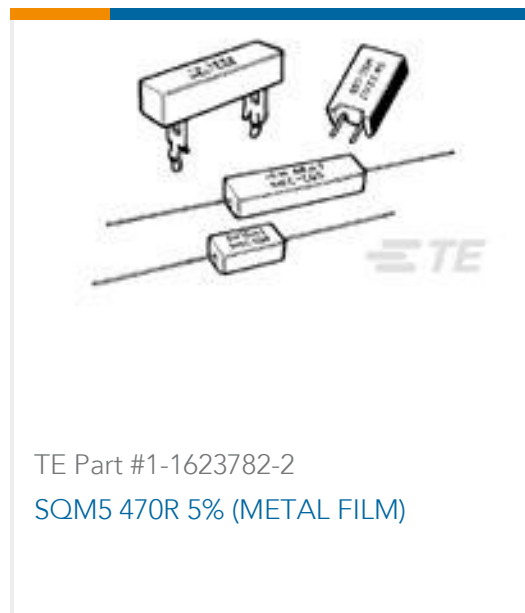



Documents

CAD Files

Customer View Model

[ENG_CVM_CVM_1393162-1_A1.2d_dxf.zip](#)

English

3D PDF

3D

Customer View Model

[ENG_CVM_CVM_1393162-1_A1.3d_igs.zip](#)

English

Customer View Model

[ENG_CVM_CVM_1393162-1_A1.3d_stp.zip](#)

English

By downloading the CAD file I accept and agree to the [Terms and Conditions](#) of use.

Datasheets & Catalog Pages

[Accessories - Miniature Relay PT](#)

English

Product Specifications

[Definitions General Purpose Relays](#)

English