

130230 ✓ ACTIVE

SOLISTRAND

TE Internal #: 130230

Closed Ring Tongue Terminal, 12 – 10 AWG, M6 Stud Size, 6.35 mm [.25 in] Stud Diameter, Closed Barrel, Straight, Tin, Uninsulated

[View on TE.com >](#)



Terminals & Splices > Ring Terminals

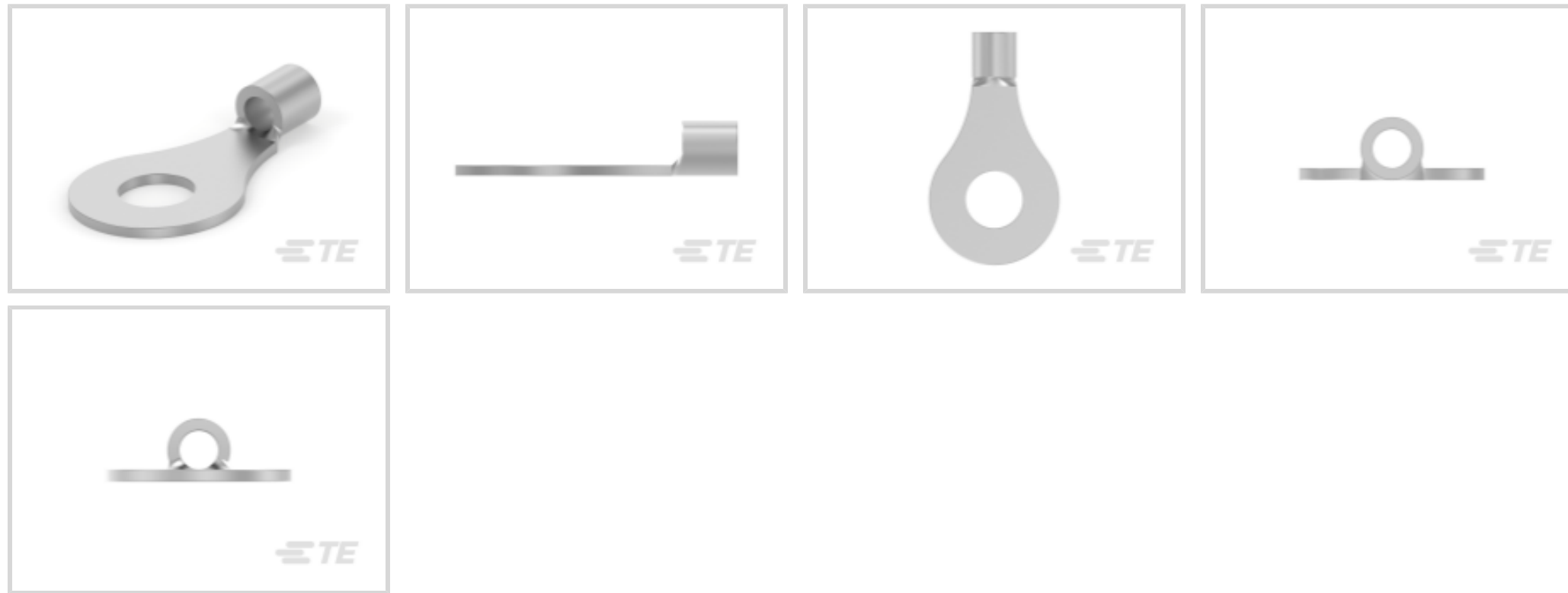

Ring Terminal Product Type: **Closed Ring Tongue Terminal**

Wire Size: **5180 – 13100 CMA**

Stud Size: **M6**

Features

Product Type Features

Ring Terminal Product Type	Closed Ring Tongue Terminal
Stud Size	M6
Sealable	No
Wire Insulation Support Retention Type	Non-Insulation Support

Contact Features

Barrel Type	Closed
Terminal Orientation	Straight
Terminal Plating Material	Tin

Mechanical Attachment

Wire Insulation Support	Without
-------------------------	---------

Dimensions

Wire Size	5180 – 13100 CMA
Stud Diameter	6.35 mm [.25 in]
Tongue Thickness	.79 mm [.031 in]
Product Length	25.5 mm [1 in]
Barrel Inside Diameter	3.28 mm [.129 in]



Usage Conditions

Insulation Option	Uninsulated
Operating Temperature Range	170 °C[338 °F]

Operation/Application

Compatible With Wire Base Material	Copper
Compatible With Wire Plating Material	Tin

Industry Standards

Government Qualified Terminal	No
-------------------------------	----

Packaging Features

Packaging Quantity	500
Packaging Method	Box

Product Compliance

[For compliance documentation, visit the product page on TE.com>](#)

EU RoHS Directive 2011/65/EU	Compliant
EU ELV Directive 2000/53/EC	Compliant
China RoHS 2 Directive MIIT Order No 32, 2016	No Restricted Materials Above Threshold
EU REACH Regulation (EC) No. 1907/2006	Current ECHA Candidate List: JUNE 2023 (235) Candidate List Declared Against: JUNE 2023 (235) Does not contain REACH SVHC
Halogen Content	Low Halogen - Br, Cl, F, I < 900 ppm per homogenous material. Also BFR/CFR/PVC Free
Solder Process Capability	Not applicable for solder process capability

Product Compliance Disclaimer

This information is provided based on reasonable inquiry of our suppliers and represents our current actual knowledge based on the information they provided. This information is subject to change. The part numbers that TE has identified as EU RoHS compliant have a maximum concentration of 0.1% by weight in homogenous materials for lead, hexavalent chromium, mercury, PBB, PBDE, DBP, BBP, DEHP, DIBP, and 0.01% for cadmium, or qualify for an exemption to these limits as defined in the Annexes of Directive 2011/65/EU (RoHS2). Finished electrical and electronic equipment products will be CE marked as required by Directive 2011/65/EU. Components may not be CE marked. Additionally, the part numbers that TE has identified as EU ELV compliant have a maximum concentration of 0.1% by weight in homogenous materials for lead, hexavalent chromium, and mercury, and 0.01% for cadmium, or qualify for an exemption to these limits as defined in the Annexes of Directive 2000/53/EC (ELV). Regarding the REACH Regulation, the information TE provides on SVHC in articles for this part number is based on the latest European Chemicals Agency (ECHA) 'Guidance on requirements for substances in articles' posted at this URL: <https://echa.europa.eu/guidance-documents/guidance-on-reach>

Compatible Parts



TE Part # 354940-1
PRO-CRIMPER III FRAME W/O DIES



TE Part # 58545-1
SOLISTRAND 10-22 DIE ASSY



TE Part # 49935
DAHT SOLIS 22-10 ASSY



TE Part # 2217483-2
KIT, BTLI, DOUBLE ACTION HEAD



TE Part # 2217483-1
KIT, BTLI, DOUBLE ACTION HEAD



TE Part # 1213855-1
SDE PNEUMATIC HAND TOOL ASSY.



TE Part # 9-1478240-0
SDE SA PEW12 HAND TOOL FRAME-NO DIES



TE Part # 1490567-1
HAND NON-LOGIC SHORT POWER UNI



TE Part # 1673611-1
SHORT TOOL HOLDER W/RATCHET

Customers Also Bought

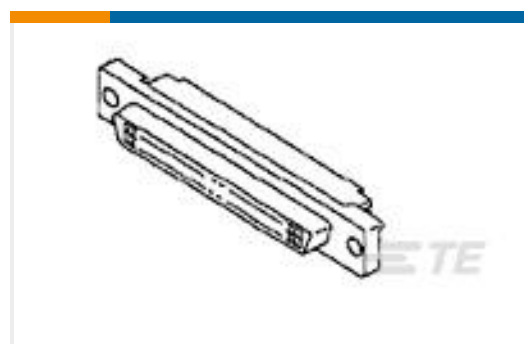

TE Part #5-749877-7
68 50SR PANEL MOUNT RCPT, ROHS



TE Part #1879075-8
THS25 R39 5%



TE Part #323062
TERMINAL,SOLIS R HR 12-10 10



TE Part #1-962915-2
TAB 2.8x0.8 CONTACT CS SWS Ag



TE Part #F57507-000
MP-406254-1.5-8A



TE Part #470398-000
MWTM-25/8-80/S(S100)



TE Part #CJ4552-000
D-141-30-LF



TE Part #AS620-35PB
PLUG BOOT TERMIN'N TYPE 6

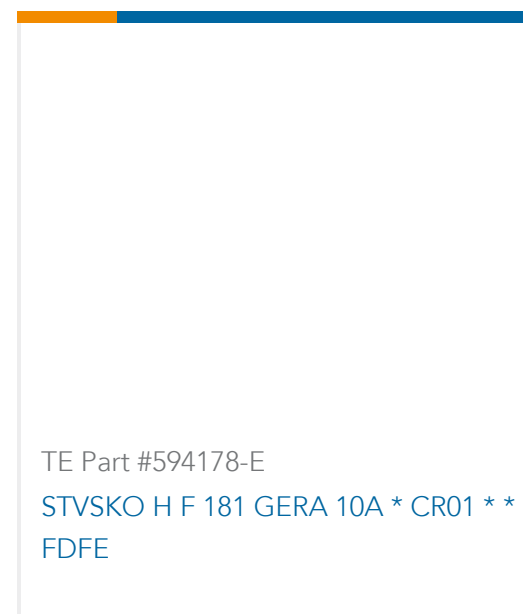

Documents

Product Drawings

SOLIS R 12-10 6MM

English

CAD Files

3D PDF

3D

Customer View Model

[ENG_CVM_CVM_130230_B.2d_dxf.zip](#)

English

Customer View Model

[ENG_CVM_CVM_130230_B.3d_igs.zip](#)

English

Customer View Model

[ENG_CVM_CVM_130230_B.3d_stp.zip](#)

English

3D PDF

English

Customer View Model

[ENG_CVM_130230_D.3d_igs.zip](#)

English

Customer View Model

[ENG_CVM_130230_D.3d_stp.zip](#)

English

Customer View Model

[ENG_CVM_130230_D.2d_dxf.zip](#)

English

By downloading the CAD file I accept and agree to the [Terms and Conditions](#) of use.

Agency Approvals

UL Report

English