

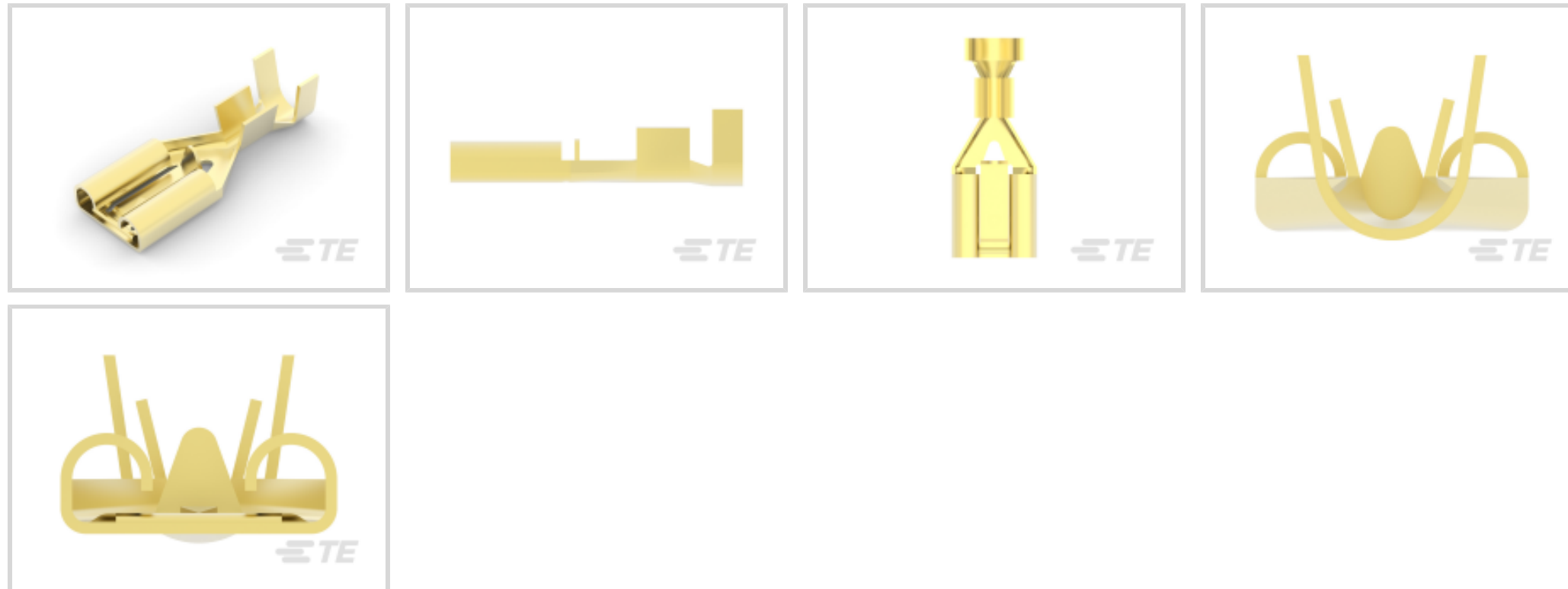

Connectors > Rectangular Connectors > Connector Contacts



Contact Type: **Socket**

Contact Mating Area Plating Material: **Tin**

Wire Contact Termination Area Plating Material: **Tin**

Operating Voltage: **240 VDC**

### Features

#### Product Type Features

Discrete Wire Type	Stranded
Connector & Contact Terminates To	Wire & Cable

#### Configuration Features

Compatible With Wire & Cable Type	Discrete Wire
-----------------------------------	---------------

#### Electrical Characteristics

Operating Voltage	240 VDC
-------------------	---------

#### Contact Features

Contact Type	Socket
Contact Mating Area Plating Material	Tin
Wire Contact Termination Area Plating Material	Tin
Contact Retention Within Housing	Without
Contact Base Material	Brass
Contact Current Rating (Max)	23.5 A

#### Termination Features

--	--



Termination Method to Wire & Cable	Crimp
------------------------------------	-------

### Dimensions

Wire Size	18 – 14 AWG
-----------	-------------

### Packaging Features

Packaging Method	Strip
------------------	-------

## Product Compliance

[For compliance documentation, visit the product page on TE.com>](#)

EU RoHS Directive 2011/65/EU	Compliant
EU ELV Directive 2000/53/EC	Compliant
China RoHS 2 Directive MIIT Order No 32, 2016	No Restricted Materials Above Threshold
EU REACH Regulation (EC) No. 1907/2006	Current ECHA Candidate List: JUNE 2023 (235) Candidate List Declared Against: JUNE 2023 (235) Does not contain REACH SVHC
Halogen Content	Low Halogen - Br, Cl, F, I < 900 ppm per homogenous material. Also BFR/CFR/PVC Free
Solder Process Capability	Not applicable for solder process capability

#### Product Compliance Disclaimer

This information is provided based on reasonable inquiry of our suppliers and represents our current actual knowledge based on the information they provided. This information is subject to change. The part numbers that TE has identified as EU RoHS compliant have a maximum concentration of 0.1% by weight in homogenous materials for lead, hexavalent chromium, mercury, PBB, PBDE, DBP, BBP, DEHP, DIBP, and 0.01% for cadmium, or qualify for an exemption to these limits as defined in the Annexes of Directive 2011/65/EU (RoHS2). Finished electrical and electronic equipment products will be CE marked as required by Directive 2011/65/EU. Components may not be CE marked. Additionally, the part numbers that TE has identified as EU ELV compliant have a maximum concentration of 0.1% by weight in homogenous materials for lead, hexavalent chromium, and mercury, and 0.01% for cadmium, or qualify for an exemption to these limits as defined in the Annexes of Directive 2000/53/EC (ELV). Regarding the REACH Regulation, the information TE provides on SVHC in articles for this part number is based on the latest European Chemicals Agency (ECHA) 'Guidance on requirements for substances in articles' posted at this URL: <https://echa.europa.eu/guidance-documents/guidance-on-reach>

## Compatible Parts



TE Part # 2150177-1  
OCEAN\_2.0\_Applicator-S-110F180F



TE Part # 2150177-2  
OCEAN\_2.0\_Applicator-S-110F180F



TE Part # 7-2150177-1  
OCEAN\_2.0\_Applicator-S-110F180F



TE Part # 7-2150177-2  
OCEAN\_2.0\_Applicator-S-110F180F



**KIT**  
REPRESENTATION ONLY

TE Part # 7-2150177-7  
OCEAN\_2.0\_SPARE\_PART\_KIT-110F180F



TE Part # 9-521205-3  
POSI-LOK HSG, .250, 3 POS RAST5



TE Part # 1217094-3  
RCPT 250 POS-LOCK 18-14 TPBR



TE Part # 1217095-3  
RCPT 250 POS-LOCK 16-12 TPBR



TE Part # 1742700-1  
RCPT 250 POS-LOCK 22-18 0126BR



TE Part # 1742700-2  
RCPT 250 POS-LOC 22-18 0126TPBR



TE Part # 1742701-1  
RCPT 250 POS-LOCK 18-14 0126BR



TE Part # 1742701-2  
RCPT 250 POS-LOCK 18-14 TPBR

TE Part # 2381765-3  
3P, POSITIVE-LOCK HOUSING, MKIII .250 SE

TE Part # 1-2381765-3  
3P, POSITIVE-LOCK HOUSING, MKIII .250 SE

## Also in the Series | RAST 5 IDC Connectors

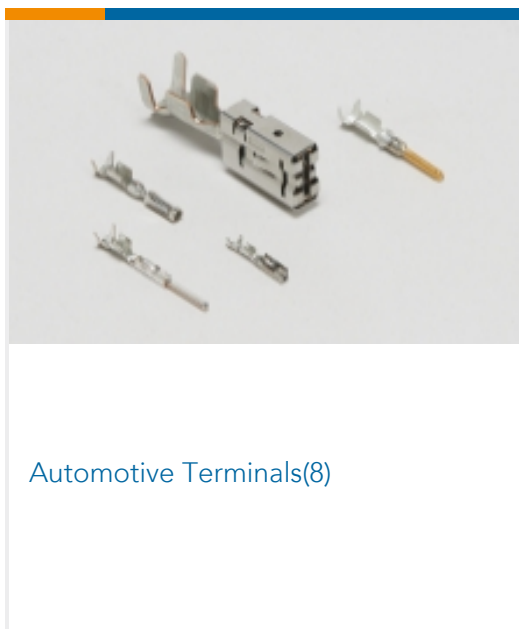

Automotive Terminals(8)

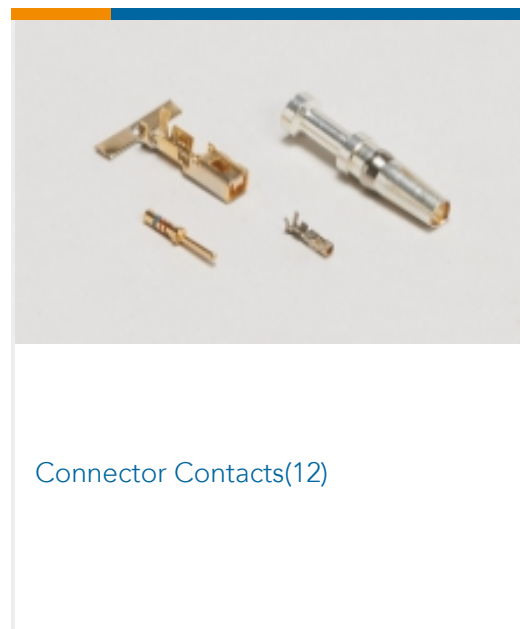

Connector Contacts(12)

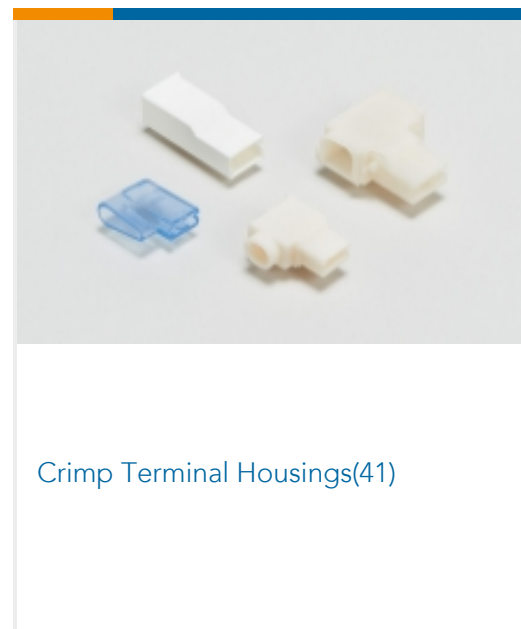

Crimp Terminal Housings(41)

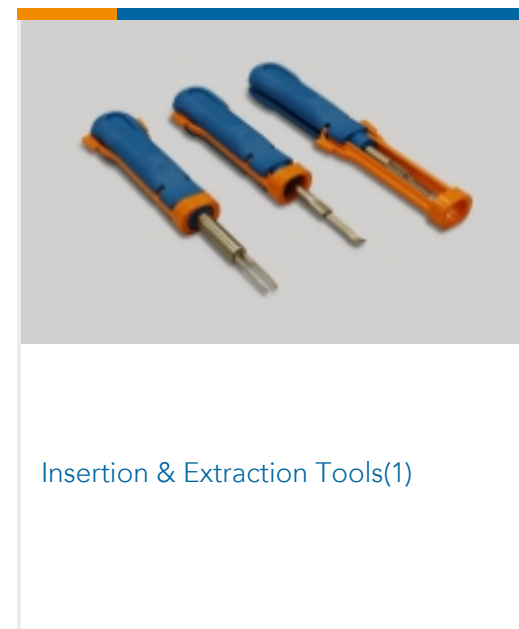

Insertion & Extraction Tools(1)



PCB Headers & Receptacles(417)



Rectangular Connector Housings(1)

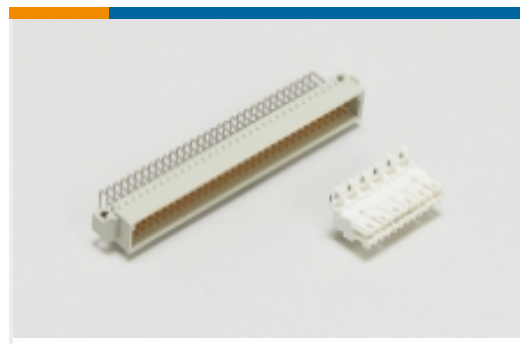

Standard Edge Connectors(34)



Standard Rectangular Connectors(68)



Wire-to-Board Connector Assemblies & Housings(214)



Wire-to-Board Connector Contacts(2)

## Customers Also Bought

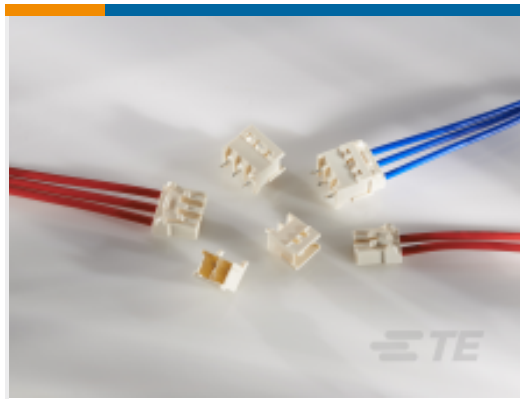

TE Part #3-2232875-1  
GIC6.0MM CONNECTOR PLUG  
HOUSING 3POS

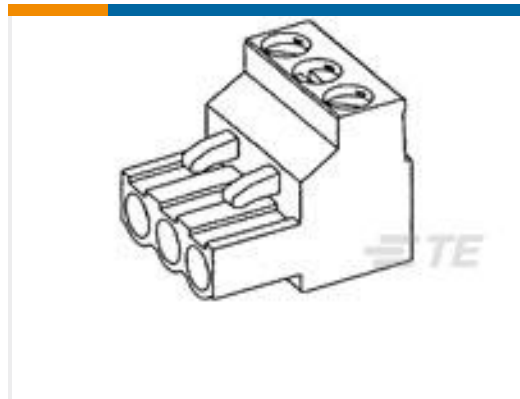

TE Part #796640-4  
4 POS 5.0 MM R/A PLUG,TRM BLK

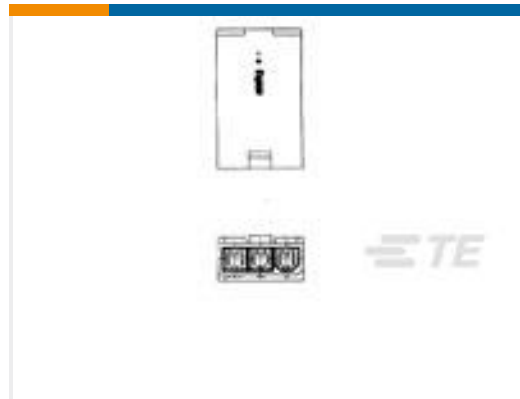

TE Part #1586105-3  
3P RCPT VAL-U-LOK SR V2



TE Part #42742-1  
250 FASTON FLAG REC 18-12 AWG  
BR



TE Part #794202-1  
14P MINI UMNL2 PLUG HSG UL94V0



TE Part #794203-1  
14P MINI UMNL2 CAP HSG UL94V0



TE Part #794228-1  
MINI UMNL2 PIN 22-18 AWG SN LP



TE Part #794229-1  
MINI UMNL2 SOK 22-18 AWG SN LP



TE Part #521207-1  
POSI-LOK HSG.250-5 POS RAST5



TE Part #794245-1  
08P MINI UMNL2 PLUG HSG UL94V2

## Documents





### Product Drawings

[RCPT 250 POS-LOCK 18-14 0126BR](#)

English

### CAD Files

[3D PDF](#)

English

**Customer View Model**

[ENG\\_CVM\\_1217094-1\\_B.3d\\_igs.zip](#)

English

**Customer View Model**

[ENG\\_CVM\\_1217094-1\\_B.3d\\_stp.zip](#)

English

**Customer View Model**

[ENG\\_CVM\\_1217094-1\\_B.2d\\_dxf.zip](#)

English

[3D PDF](#)

3D

**Customer View Model**

[ENG\\_CVM\\_CVM\\_1217094-1\\_C.2d\\_dxf.zip](#)

English

**Customer View Model**

[ENG\\_CVM\\_CVM\\_1217094-1\\_C.3d\\_igs.zip](#)

English

**Customer View Model**

[ENG\\_CVM\\_CVM\\_1217094-1\\_C.3d\\_stp.zip](#)

English

By downloading the CAD file I accept and agree to the [Terms and Conditions](#) of use.

### Datasheets & Catalog Pages

[1654742\\_HOUSEHOLD\\_APPLIANCES\\_RAST5](#)

English

[Positive Lock Receptacles](#)

English

### Product Specifications

[Application Specification](#)

English

### Product Environmental Compliance

[MD\\_1217094-1\\_020620182346\\_dmtec](#)

English

[MD\\_1217094-1\\_020620182346\\_dmtec](#)

English