

1217092-1 ✓ ACTIVE

Positive Lock | Mark III, Positive Lock 250

TE Internal #: 1217092-1

Quick Disconnects, Receptacle, 16 – 12 AWG Wire Size, 1.31 – 3.31 mm² Wire Size, Mating Tab Width 6.35 mm [.25 in], Straight, Brass, Positive Lock 250

[View on TE.com >](#)



Terminals & Splices > Quick Disconnects

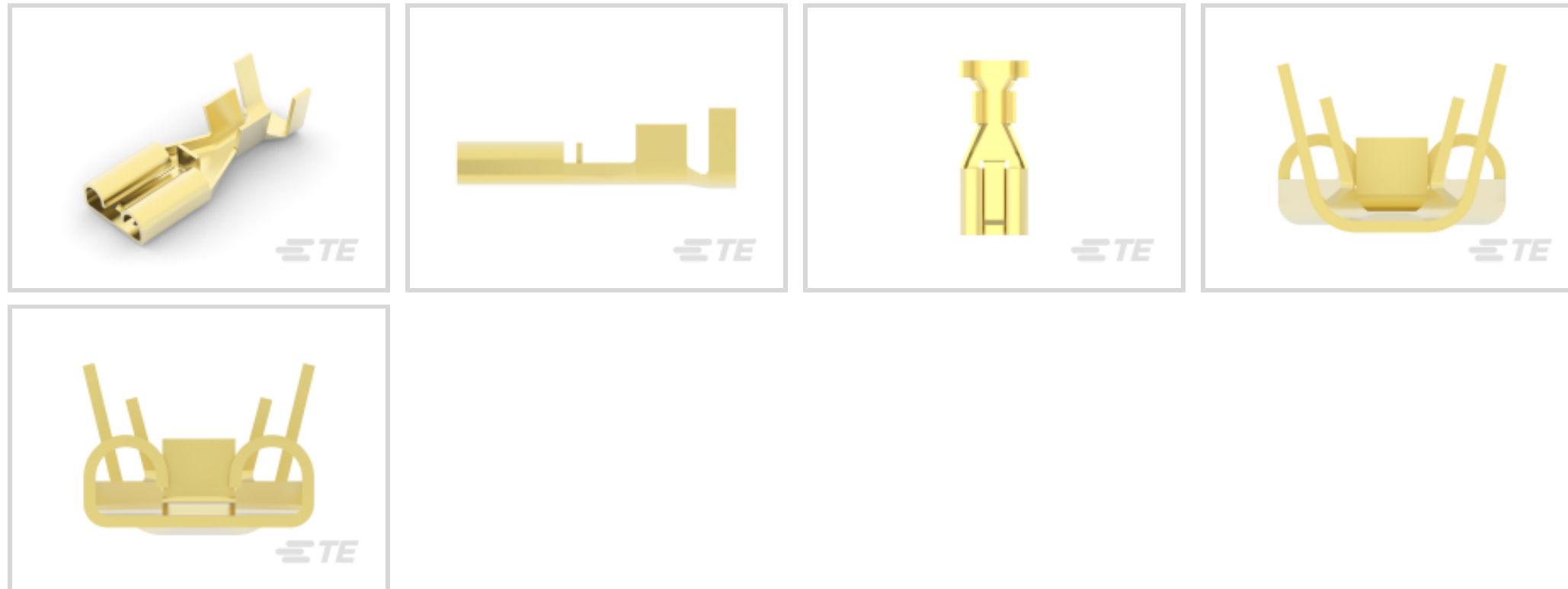

Quick Disconnect Terminal Type: **Receptacle**

Wire Size: 1.31 – 3.31 mm²

Mating Tab Width: 6.35 mm [.25 in]

Mating Tab Thickness: .81 mm [.032 in]

Features

Product Type Features

Insertion Force	Low
-----------------	-----

Configuration Features

Connection Capacity	Single
---------------------	--------

Compatible With Wire & Cable Type	Discrete Wire
-----------------------------------	---------------

Contact Features

Quick Disconnect Terminal Type	Receptacle
--------------------------------	------------

Mating Tab Width	6.35 mm [.25 in]
------------------	------------------

Mating Tab Thickness	.81 mm [.032 in]
----------------------	------------------

Terminal Orientation	Straight
----------------------	----------

Contact Base Material	Brass
-----------------------	-------

Terminal Plating Material	Unplated
---------------------------	----------

Crimp Type	F-Crimp
------------	---------

Barrel Type	Open
-------------	------

Termination Features



Product Terminates To	Wire & Cable
-----------------------	--------------

Mechanical Attachment

Wire Insulation Support	With
Mating Retention Type	Dimple

Dimensions

Terminal Material Thickness	.41 mm[.016 in]
Product Length	19.58 mm[.771 in]
Compatible Insulation Diameter Range	3.1 – 4.3 mm[.12 – .169 in]
Wire Size	1.31 – 3.31 mm ²

Usage Conditions

Insulation Option	Uninsulated
Operating Temperature Range	-40 – 110 °C[-40 – 230 °F]

Industry Standards

Agency/Standard	UL
-----------------	----

Packaging Features

Packaging Quantity	10000
Packaging Method	Strip/Reel

Other

Terminals & Splices Comment	Also accepts wire combos.
-----------------------------	---------------------------

Product Compliance

[For compliance documentation, visit the product page on TE.com>](#)

EU RoHS Directive 2011/65/EU	Compliant
EU ELV Directive 2000/53/EC	Compliant
China RoHS 2 Directive MIIT Order No 32, 2016	No Restricted Materials Above Threshold
EU REACH Regulation (EC) No. 1907/2006	Current ECHA Candidate List: JUNE 2023 (235) Candidate List Declared Against: JUNE 2022 (224) Does not contain REACH SVHC
Halogen Content	Low Halogen - Br, Cl, F, I < 900 ppm per homogenous material. Also BFR/CFR/PVC Free
Solder Process Capability	Not applicable for solder process capability

Product Compliance Disclaimer

This information is provided based on reasonable inquiry of our suppliers and represents our current actual knowledge based on the information they provided. This information is subject to change. The part numbers that TE has identified as EU RoHS compliant have a maximum concentration of 0.1% by weight in homogenous materials for lead, hexavalent chromium, mercury, PBB, PBDE, DBP, BBP, DEHP, DIBP, and 0.01% for cadmium, or qualify for an exemption to these limits as defined in the Annexes of Directive 2011/65/EU (RoHS2). Finished electrical and electronic equipment products will be CE marked as required by Directive 2011/65/EU. Components may not be CE marked. Additionally, the part numbers that TE has identified as EU ELV compliant have a maximum concentration of 0.1% by weight in homogenous materials for lead, hexavalent chromium, and mercury, and 0.01% for cadmium, or qualify for an exemption to these limits as defined in the Annexes of Directive 2000/53/EC (ELV). Regarding the REACH Regulation, the information TE provides on SVHC in articles for this part number is based on the latest European Chemicals Agency (ECHA) 'Guidance on requirements for substances in articles' posted at this URL: <https://echa.europa.eu/guidance-documents/guidance-on-reach>

Compatible Parts





TE Part # 142680-9
PL 187 REC HSG 2P NYLON WHITE



TE Part # 520935-3
PL&STANDARD FASTON 250 HOUSING REC BLA



TE Part # 142680-1
PL MK III 2 POS HOUSING BROEN RAL 8016



TE Part # 1-520935-5
PL 250 HOUSING REC BLUE 6/6 NYLON V2



TE Part # 520935-7
PLMKII&FASTON 250 REC HSG 2P BROWN



TE Part # 520935-6
PL&STANDARD FASTON 250 HSG REC YELLOW



TE Part # 520935-4
PL&STANDARD FASTON 250 HSG REC GREEN



TE Part # 521119-1
PL 250 HOUSING RECEPTACLE NYLON 6/6

Also in the Series | **Mark III**

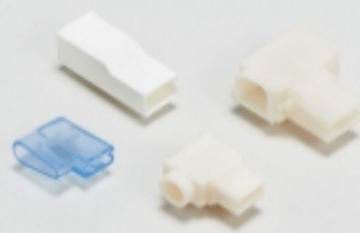

Crimp Terminal Housings(30)



Quick Disconnects(15)

Also in the Series | **Positive Lock 250**

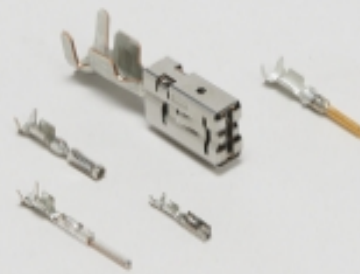

Automotive Terminals(1)

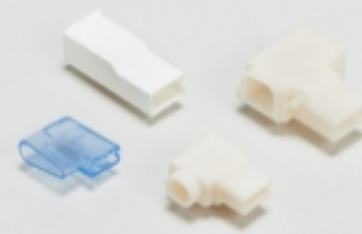

Crimp Terminal Housings(193)



Insertion & Extraction Tools(3)



Insulation Boots & Sleeves(4)



Quick Disconnects(186)

Customers Also Bought



TE Part #1393030-8
SSR-240D25R=PANL MNT,25A,
240VAC,R-DC i/p



TE Part #1415526-1
PT78722

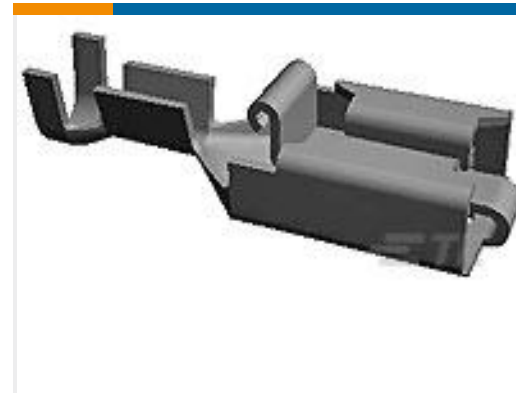

TE Part #154717-1
PL 250 REC TERMINAL 13-11 AWG BR



TE Part #172128-1
FF 250 REC HSG 1P NYLON NAT



TE Part #2232343-1
250 PL EX FLAG REC. 18-12AWG PTBR



TE Part #1744426-2
Header Housing Assy, EP 2.5 RA, 2 Pos.



TE Part #972203-000
S03-02-R-100



TE Part #2196060-1
1.5MM SER SEALED TAB TERMINAL

Documents

Product Drawings

PL 250 TERMINAL RECEPTACLE 16-12 AWG BR

English

CAD Files

3D PDF

3D

Customer View Model

[ENG_CVM_CVM_1217092-1_E.2d_dxf.zip](#)

English

Customer View Model

[ENG_CVM_CVM_1217092-1_E.3d_igs.zip](#)

English

Customer View Model

[ENG_CVM_CVM_1217092-1_E.3d_stp.zip](#)

English

By downloading the CAD file I accept and agree to the [Terms and Conditions](#) of use.



Datasheets & Catalog Pages

[1654742_HOUSEHOLD_APPLIANCES_RAST5](#)

English

Positive Lock Receptacles

English

Product Specifications

[Application Specification](#)

English

Product Environmental Compliance

[TE Material Declaration](#)

English