



Timer Connector System

TE Internal #: 1217071-1

Quick Disconnects, Tab, 20 – 16 AWG Wire Size, .51 – 1.31 mm²

Wire Size, Mating Tab Width 3.18 mm [.125 in], Straight, Brass,

Timer Connector System

[View on TE.com >](#)

Terminals & Splices > Quick Disconnects



Quick Disconnect Terminal Type: **Tab**

Wire Size: **.51 – 1.31 mm²**

Mating Tab Width: **3.18 mm [.125 in]**

Mating Tab Thickness: **.51 mm [.02 in]**

Features

Configuration Features

Connection Capacity	Single
Compatible With Wire & Cable Type	Discrete Wire

Contact Features

Quick Disconnect Terminal Type	Tab
Mating Tab Width	3.18 mm [.125 in]
Mating Tab Thickness	.51 mm [.02 in]
Terminal Orientation	Straight
Contact Base Material	Brass
Terminal Plating Material	Tin
Crimp Type	F-Crimp
Barrel Type	Open

Termination Features

Product Terminates To	Wire & Cable
-----------------------	--------------

Mechanical Attachment

--	--



Wire Insulation Support	With
-------------------------	------

Dimensions

Terminal Material Thickness	.51 mm [.02 in]
Product Length	23.88 mm [.94 in]
Compatible Insulation Diameter Range	2.85 – 3.12 mm [.112 – .123 in]
Wire Size	.51 – 1.31 mm ²

Usage Conditions

Insulation Option	Uninsulated
Operating Temperature Range	-40 – 110 °C [-40 – 230 °F]

Packaging Features

Packaging Quantity	3000
Packaging Method	Strip/Reel

Product Compliance

[For compliance documentation, visit the product page on TE.com>](#)

EU RoHS Directive 2011/65/EU	Compliant
EU ELV Directive 2000/53/EC	Compliant
China RoHS 2 Directive MIIT Order No 32, 2016	No Restricted Materials Above Threshold
EU REACH Regulation (EC) No. 1907/2006	Current ECHA Candidate List: JUNE 2023 (235) Candidate List Declared Against: JUNE 2023 (235) Does not contain REACH SVHC
Halogen Content	Low Halogen - Br, Cl, F, I < 900 ppm per homogenous material. Also BFR/CFR/PVC Free
Solder Process Capability	Not applicable for solder process capability

Product Compliance Disclaimer

This information is provided based on reasonable inquiry of our suppliers and represents our current actual knowledge based on the information they provided. This information is subject to change. The part numbers that TE has identified as EU RoHS compliant have a maximum concentration of 0.1% by weight in homogenous materials for lead, hexavalent chromium, mercury, PBB, PBDE, DBP, BBP, DEHP, DIBP, and 0.01% for cadmium, or qualify for an exemption to these limits as defined in the Annexes of Directive 2011/65/EU (RoHS2). Finished electrical and electronic equipment products will be CE marked as required by Directive 2011/65/EU. Components may not be CE marked. Additionally, the part numbers that TE has identified as EU ELV compliant have a maximum concentration of 0.1% by weight in homogenous materials for lead, hexavalent chromium, and mercury, and 0.01% for cadmium, or qualify for an exemption to these limits as defined in the Annexes of Directive 2000/53/EC (ELV). Regarding the REACH Regulation, the information TE provides on SVHC in articles for this part number is based on the latest European Chemicals Agency (ECHA) 'Guidance on requirements for substances in articles' posted at this URL: <https://echa.europa.eu/guidance-documents/guidance-on-reach>

Compatible Parts



TE Part # 2305570-1
Strip Terminal Cutter-Side Feed-No Crimp



TE Part # 2151757-1
OC-AT-S-FM-100F155F-001-0331



TE Part # 2151757-2
OC-AT-S-FA-100F155F-001-0331



TE Part # 7-2151757-7
OC-100F155F-CRIMPTOOLINGKIT

Also in the Series | Timer Connector System



Automotive Connector Caps & Covers (12)

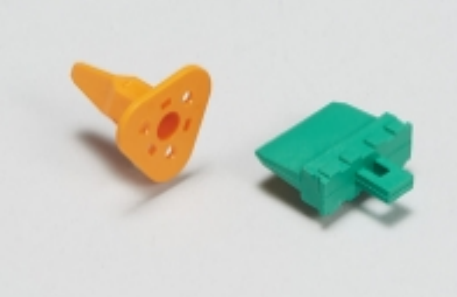

Automotive Connector Locks & Position Assurance(17)



Automotive Housings(233)



Automotive Terminals(145)



Connector Seals & Cavity Plugs(32)

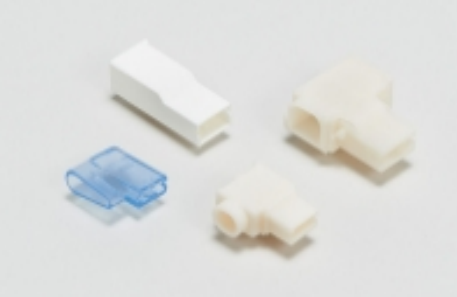

Crimp Terminal Housings(13)



Insertion & Extraction Tools(18)

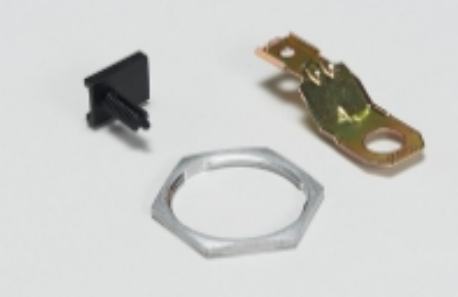

Other Automotive Connector Accessories(1)



PCB Headers & Receptacles(82)



Quick Disconnects(4)

Customers Also Bought



TE Part #1971784-2
PTL TAB CONTACT, 16-19 AWG, 2X22
AWG



TE Part #CA6922-000
203W301-25-G02-0



TE Part #60249-2
FF 250 REC 16-12AWG TPBR



TE Part #1-1123722-3
3.96 EP PLUG HSG 3P(NATURAL)



TE Part #42100-2
FF 250 REC 18-14AWG TPBR

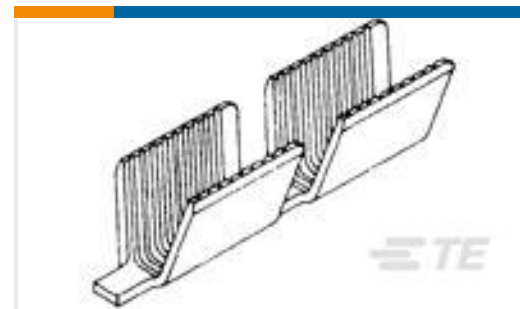

TE Part #62309-2
AMVAR SPLC 5000-10000 025TPBR



TE Part #883099-000
222A111-25-G07-0



TE Part #1394430-3
MAG MATE CONT. 5D

Documents

Product Drawings

[CONTACT, BLADE 125 20-16 AWG TPBR](#)

English

CAD Files

Customer View Model

[ENG_CVM_CVM_1217071-1_E.2d_dxf.zip](#)

English

[3D PDF](#)

3D

Customer View Model

[ENG_CVM_CVM_1217071-1_E.3d_igs.zip](#)

English

Customer View Model

[ENG_CVM_CVM_1217071-1_E.3d_stp.zip](#)

English

By downloading the CAD file I accept and agree to the [Terms and Conditions](#) of use.

Product Specifications

[Application Specification](#)

English