

1123343-2 ✓ ACTIVE

AMP | TH/.025 Connector System

TE Internal #: 1123343-2

Automotive Terminals, Receptacle, Mating Tab Width .64 mm [.025 in], Tab Thickness .64 mm [.025 in], 24 – 20 AWG Wire Size, TH/.025 Connector System

[View on TE.com >](#)



Terminals & Splices > Automotive Terminals > TH/.025 CONNECTOR SYSTEM, RECPT AND TAB

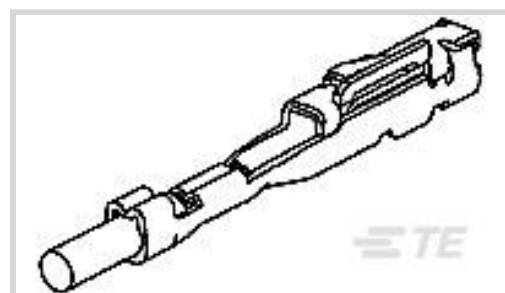

Terminal Type: **Receptacle**

Mating Tab Width: **.64 mm [.025 in]**

Mating Tab Thickness: **.64 mm [.025 in]**

Terminal Transmits: **0 – 24 A (Low Power)**

Wire Size: **24 – 20 AWG**

[All TH/.025 CONNECTOR SYSTEM, RECPT AND TAB \(27\)](#)

Features

Product Type Features

Receptacle Style	180°
Sealable	No
Primary Locking Feature	Locking Lance

Contact Features

Contact Size	.64mm
Contact Fabrication	Stamped & Formed
Wire Contact Termination Area Plating Material	Gold
Typical Current Rating	4 A
Crimp Type	F-Crimp
Terminal Type	Receptacle
Mating Tab Width	.64 mm[.025 in]
Mating Tab Thickness	.64 mm[.025 in]
Interface Plating	Gold (Au)

Termination Features

Termination Method to Wire & Cable	Crimp
Product Terminates To	Wire

Dimensions



Compatible Insulation Diameter Range	.95 – 1.72 mm [.037 – .067 in]
Wire Size	.22 – .56 mm ²
Wire Size Search	20 AWG, 21 AWG, 22 AWG, 23 AWG, 24 AWG

Usage Conditions

Insulation Option	Uninsulated
Operating Temperature (Max)	80 °C, 85 °C, 90 °C, 100 °C, 105 °C, 110 °C, 120 °C, 125 °C, 130 °C, 140 °C [176 °F][185 °F][194 °F][212 °F][221 °F][230 °F][248 °F][257 °F][266 °F][284 °F]
Operating Temperature Range	-40 – 140 °C [-40 – 284 °F]

Operation/Application

Compatible With Wire Base Material	Copper
------------------------------------	--------

Packaging Features

Packaging Quantity	10000
Packaging Method	Reel

Other

Terminal Transmits	0 – 24 A (Low Power)
--------------------	----------------------

Product Compliance

[For compliance documentation, visit the product page on TE.com>](#)

EU RoHS Directive 2011/65/EU	Compliant
EU ELV Directive 2000/53/EC	Compliant
China RoHS 2 Directive MIIT Order No 32, 2016	No Restricted Materials Above Threshold
EU REACH Regulation (EC) No. 1907/2006	Current ECHA Candidate List: JUNE 2023 (235) Candidate List Declared Against: JUNE 2023 (235) Does not contain REACH SVHC
Halogen Content	Low Halogen - Br, Cl, F, I < 900 ppm per homogenous material. Also BFR/CFR/PVC Free
Solder Process Capability	Not applicable for solder process capability

Product Compliance Disclaimer

This information is provided based on reasonable inquiry of our suppliers and represents our current actual knowledge based on the information they provided. This information is subject to change. The part numbers that TE has identified as

EU RoHS compliant have a maximum concentration of 0.1% by weight in homogenous materials for lead, hexavalent chromium, mercury, PBB, PBDE, DBP, BBP, DEHP, DIBP, and 0.01% for cadmium, or qualify for an exemption to these limits as defined in the Annexes of Directive 2011/65/EU (RoHS2). Finished electrical and electronic equipment products will be CE marked as required by Directive 2011/65/EU. Components may not be CE marked. Additionally, the part numbers that TE has identified as EU ELV compliant have a maximum concentration of 0.1% by weight in homogenous materials for lead, hexavalent chromium, and mercury, and 0.01% for cadmium, or qualify for an exemption to these limits as defined in the Annexes of Directive 2000/53/EC (ELV). Regarding the REACH Regulation, the information TE provides on SVHC in articles for this part number is based on the latest European Chemicals Agency (ECHA) 'Guidance on requirements for substances in articles' posted at this URL: <https://echa.europa.eu/guidance-documents/guidance-on-reach>

Compatible Parts



TE Part # CAT-T319-CH8172
TH/.025 CONNECTOR SYSTEM,
HOUSING



TE Part # 1276565-1
EXTRACTION TOOL FOR .025 REC



TE Part # 2305570-1
Strip Terminal Cutter-Side Feed-No
Crimp



TE Part # CAT-HPCH5372
High Pin Count Header



TE Part # CAT-M9194-CH8172
MULTILOCK, CONNECTOR HOUSING



TE Part # CAT-SIGH262
Signal Header



TE Part # 1717396-3
0.64 SMD 16P CAP ASSEMBLY V-TYPE
Tray



TE Part # 1463260-1
DAHT 025 TAB REC G-Tab 22-20 ASSY



TE Part # 2151494-1
OCEAN_2.0_APPLICATOR-S-055F055F



TE Part # 2151494-2
OCEAN_2.0_APPLICATOR-S-055F055F



TE Part # 5-2151494-1
OCEAN_2.0_APPLICATOR-S-055F055F



TE Part # 5-2151494-2
OCEAN_2.0_APPLICATOR-S-055F055F



TE Part # 7-2151494-1
OCEAN_2.0_APPLICATOR-S-055F055F



TE Part # 7-2151494-2
OCEAN_2.0_APPLICATOR-S-055F055F



KIT
TE Part # 7-2151494-7
OCEAN_2.0_SPARE_PART_KIT-
055F055F



KIT
TE Part # 7-2836361-7
OC-140F140F-752-CRIMPTOOLINGKIT



TE Part # 2-2151494-1
OCEAN_2.0_APPLICATOR-S-055F055F



TE Part # 7-1579014-2
HT11K HAND TOOL TH 0.25 CONTACTS

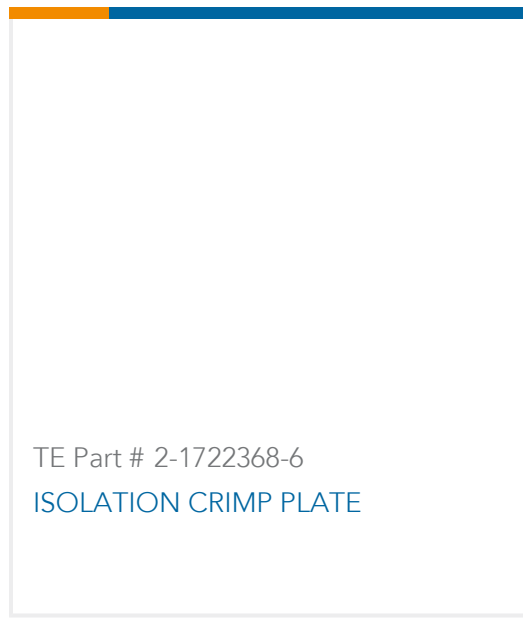

TE Part # 2-1722368-6
ISOLATION CRIMP PLATE



TE Part # 6318853-3
025 24 pos Cap Assy H 4 Au

Also in the Series | TH/.025 Connector System

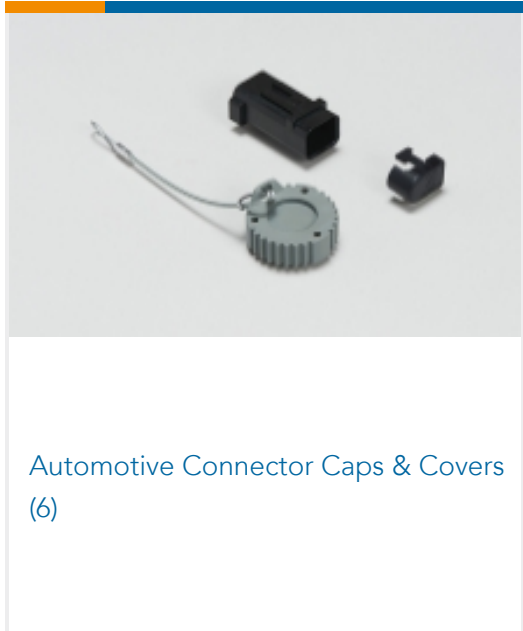

Automotive Connector Caps & Covers (6)

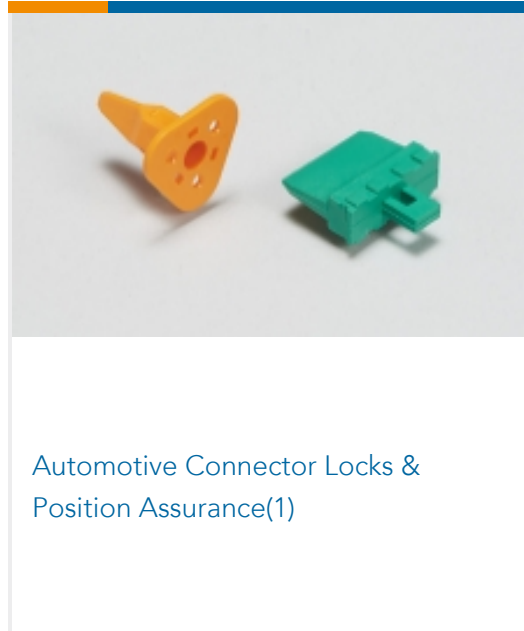

Automotive Connector Locks & Position Assurance(1)

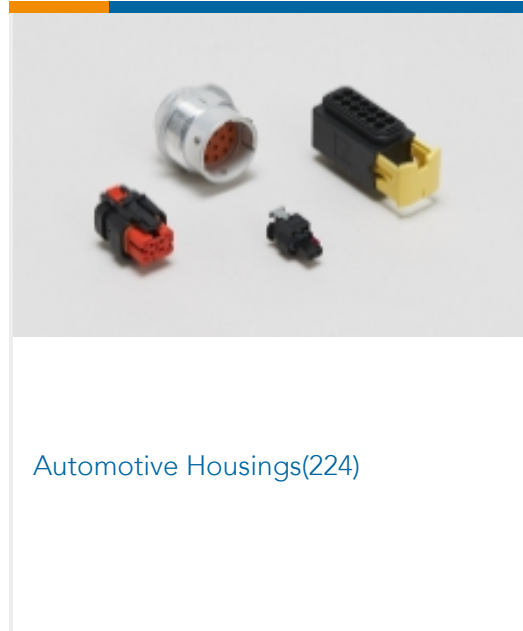

Automotive Housings(224)

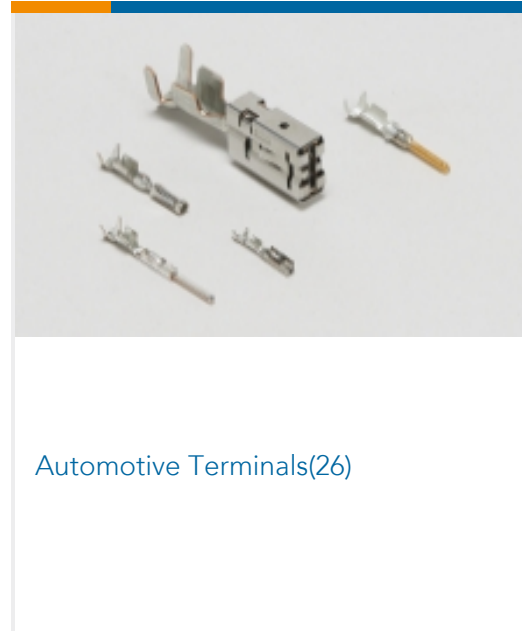

Automotive Terminals(26)

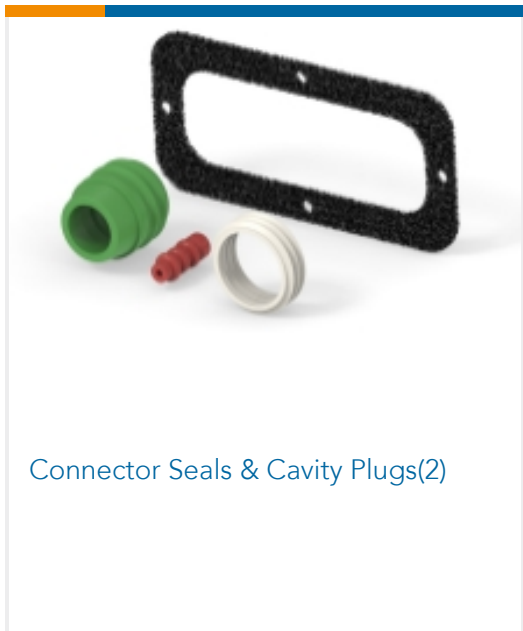

Connector Seals & Cavity Plugs(2)

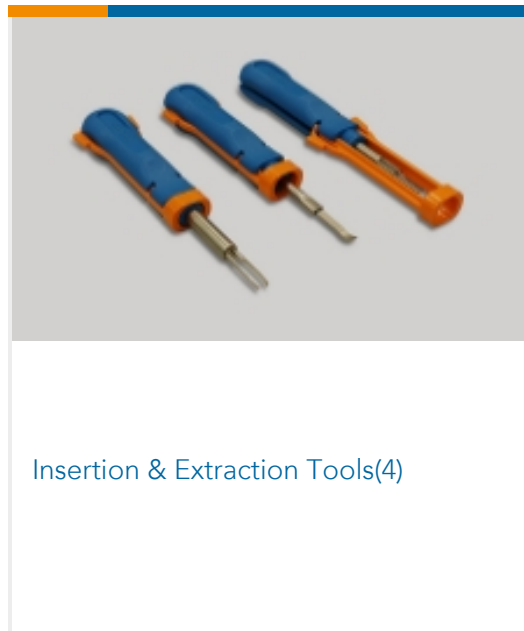

Insertion & Extraction Tools(4)

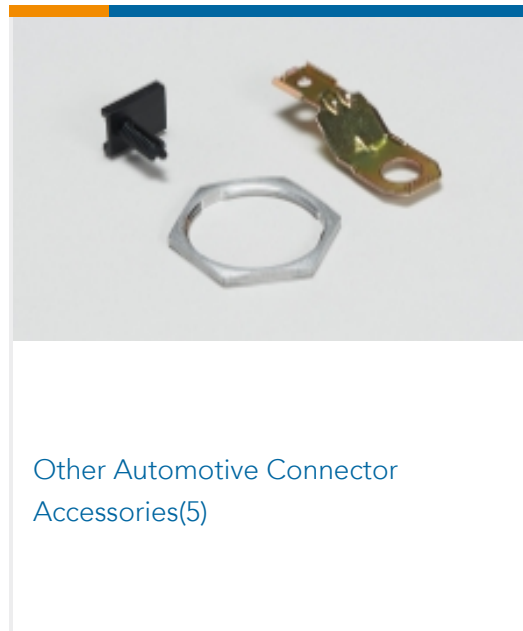

Other Automotive Connector Accessories(5)



PCB Headers & Receptacles(163)

Customers Also Bought



TE Part #5-534267-1
14 MODIV VRT DR DE 100/125



TE Part #1123339-1
TH/.025 CONNECTOR SYSTEM, HOUSING



TE Part #1379165-4
4pos MQS .63 header 180deg THR



TE Part #1123343-1
025 REC CONTACT



TE Part #1604800-5
Plug Kit, 12 Pos Quadrax

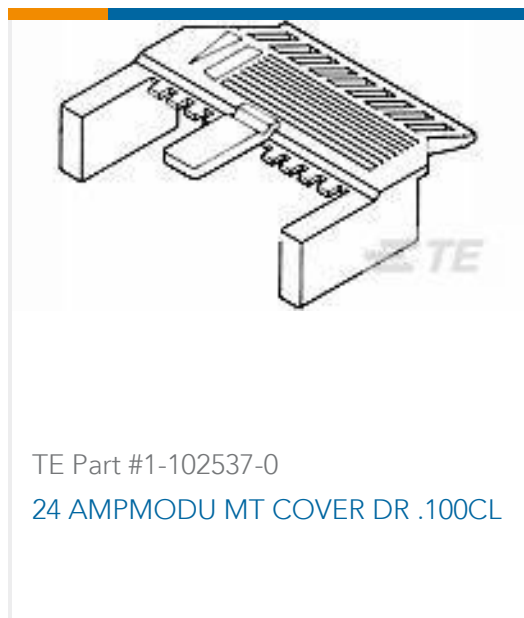

TE Part #1-102537-0
24 AMPMODU MT COVER DR .100CL



TE Part #2330010-1
0.64 SMD 40POSITION CAP ASSEMBLY V-TYPE

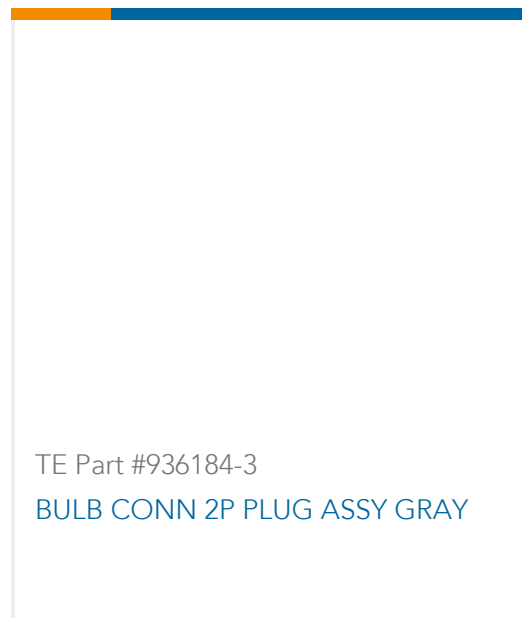

TE Part #936184-3
BULB CONN 2P PLUG ASSY GRAY



Documents

Product Drawings

[025 REC CONTACT GOLD FORMING](#)

Japanese

CAD Files

[3D PDF](#)

3D

Customer View Model

[ENG_CVM_CVM_1123343-2_M.2d_dxf.zip](#)

English

Customer View Model

[ENG_CVM_CVM_1123343-2_M.3d_igs.zip](#)

English

Customer View Model

[ENG_CVM_CVM_1123343-2_M.3d_stp.zip](#)

English

By downloading the CAD file I accept and agree to the [Terms and Conditions](#) of use.

Datasheets & Catalog Pages

[TH/.025 Connector Series](#)

English

Product Specifications

[Application Specification](#)

English

[Application Specification](#)

Japanese

[Crimping .040III Unsealed Contact, Receptacle](#)

Japanese

[Crimping of 025 Receptacle Contact](#)

Japanese

[Application Specification](#)

Japanese

[Crimping of 025 Receptacle Contact](#)

Japanese



Application Specification

Japanese

Instruction Sheets

025/090II I/O Connector

Japanese

Instruction Sheet (non U.S.)

Japanese

025/090II I/O Connector

Japanese

Instruction Sheet (non U.S.)

Japanese

Instruction Sheet (non U.S.)

English

Instruction Sheet (non U.S.)

Japanese

025/040 I/O Connector

Japanese

Instruction Sheet (non U.S.)

Japanese

025/040 I/O Connector

Japanese

Instruction Sheet (non U.S.)

English

025(0.64)/375(9.5) HYBRID Connector

English

Instruction Sheet (non U.S.)

English

025(0.64)/375(9.5) HYBRID Connector

English

025(0.64)/187(4.8) I/O CONNECTOR

Japanese

Instruction Sheet (non U.S.)

Japanese

025(0.64)/187(4.8) I/O CONNECTOR

Japanese

Instruction Sheet (non U.S.)

Japanese