

1062-12-0144 ✓ ACTIVE

DEUTSCH | DEUTSCH Common Contact

TE Internal #: 1062-12-0144

Automotive Terminals, Socket, Pin Diameter 2.39 mm [.094 in], 14 – 12 AWG Wire Size, 2 – 3 mm² Wire Size, DEUTSCH Common Contact

[View on TE.com >](#)



Terminals & Splices > Automotive Terminals



Terminal Type: **Socket**

Mating Pin Diameter: 2.39 mm [.094 in]

Terminal Transmits: 25 – 40 A (Power)

Wire Size: 2 – 3 mm²

Features

Product Type Features

Sealable	No
Primary Locking Feature	On the Terminal

Contact Features

Contact Size	Size 12
Contact Fabrication	Stamped & Formed
Wire Contact Termination Area Plating Material	Tin
Typical Current Rating	25 A
Crimp Type	F-Crimp
Terminal Type	Socket
Mating Pin Diameter	2.39 mm [.094 in]
Interface Plating	Gold (Au)

Termination Features

Termination Method to Wire & Cable	Crimp
Product Terminates To	Wire

Dimensions

Compatible Insulation Diameter Range	2.87 – 4.47 mm [.113 – .176 in]
Wire Size	2 – 3 mm ²
Wire Size Search	12 AWG, 13 AWG, 14 AWG



Usage Conditions

Insulation Option	Uninsulated
Operating Temperature (Max)	80 °C, 85 °C, 90 °C, 100 °C, 105 °C, 110 °C, 120 °C, 125 °C, 130 °C, 140 °C, 145 °C, 150 °C [176 °F][185 °F][194 °F][212 °F][221 °F][230 °F][248 °F][257 °F][266 °F][284 °F][293 °F][302 °F]
Operating Temperature Range	-55 – 150 °C[-67 – 302 °F]

Operation/Application

Compatible With Wire Base Material	Copper
------------------------------------	--------

Packaging Features

Packaging Quantity	2500
Packaging Method	Reel

Other

Customer Preferred Contact	Yes
Terminal Transmits	25 – 40 A (Power)

Product Compliance

[For compliance documentation, visit the product page on TE.com>](#)

EU RoHS Directive 2011/65/EU	Compliant
EU ELV Directive 2000/53/EC	Compliant
China RoHS 2 Directive MIIT Order No 32, 2016	No Restricted Materials Above Threshold
EU REACH Regulation (EC) No. 1907/2006	Current ECHA Candidate List: JUNE 2023 (235) Candidate List Declared Against: JUNE 2023 (235) Does not contain REACH SVHC
Halogen Content	Low Halogen - Br, Cl, F, I < 900 ppm per homogenous material. Also BFR/CFR/PVC Free
Solder Process Capability	Not reviewed for solder process capability

Product Compliance Disclaimer

This information is provided based on reasonable inquiry of our suppliers and represents our current actual knowledge based on the information they provided. This information is subject to change. The part numbers that TE has identified as EU RoHS compliant have a maximum concentration of 0.1% by weight in homogenous materials for lead, hexavalent chromium, mercury, PBB, PBDE, DBP, BBP, DEHP, DIBP, and 0.01% for cadmium, or qualify for an exemption to these limits as defined in the Annexes of Directive 2011/65/EU (RoHS2). Finished electrical and electronic equipment products will be CE marked as required by Directive 2011/65/EU. Components may not be CE marked. Additionally, the part numbers that TE has identified as EU ELV compliant have a maximum concentration of 0.1% by weight in homogenous

materials for lead, hexavalent chromium, and mercury, and 0.01% for cadmium, or qualify for an exemption to these limits as defined in the Annexes of Directive 2000/53/EC (ELV). Regarding the REACH Regulation, the information TE provides on SVHC in articles for this part number is based on the latest European Chemicals Agency (ECHA) 'Guidance on requirements for substances in articles' posted at this URL: <https://echa.europa.eu/guidance-documents/guidance-on-reach>

Compatible Parts



TE Part # CAT-H3930-CH8172
DEUTSCH HD30 Housings



TE Part # CAT-H396-CH8172
DEUTSCH HDP20 Housings



TE Part # CAT-D486-CH8172
DEUTSCH DTP Housings



TE Part # CAT-D781-CH8172
DEUTSCH DRB Housings



TE Part # CAT-D799-CH8172
DEUTSCH DRC Housings



TE Part # JS-12-00
JIFFY SPLICE, size 12



TE Part # CAT-D48-PCH8172
DEUTSCH DTHD Housings



TE Part # CAT-H991-CH8172
AMPSEAL 16 Hybrid Lever Housings



TE Part # CAT-D48-ST273
DEUTSCH Solid Contacts



TE Part # 1060-12-0144
PIN, SF, SIZE 12, 12-14, AU/SN



TE Part # HDP26-24-14SN-L015
PLG, 14P, BLK, N, THD, 4/12/16, S



TE Part # HDP26-24-16SN-L015
PLG, 16P, BLK, N, THD, 12, S



TE Part # DTT-12-00
CRIMP TOOL



TE Part # CAT-H3910-CH8172
DEUTSCH HD10 Housings



TE Part # DRCP28-86SA
PLG, 86P, BLK, 12/20, A



TE Part # 2-2266124-1
OCEAN_2.0_Applicator-S-117F156O



TE Part # 2-2266124-2
OCEAN_2.0_Applicator-S-117F156O



TE Part # 2-2266125-1
OCEAN-2.0-APPLICATOR-S-117F134O



TE Part # 2-2266125-2
OCEAN-2.0-APPLICATOR-S-117F134O



TE Part # 2-2266126-1
OCEAN_2.0_APPPLICATOR-S-117F114O

Also in the Series | DEUTSCH Common Contact

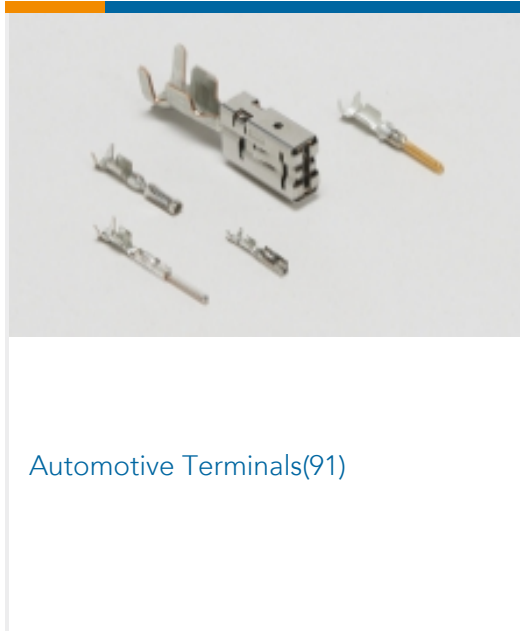

Automotive Terminals(91)

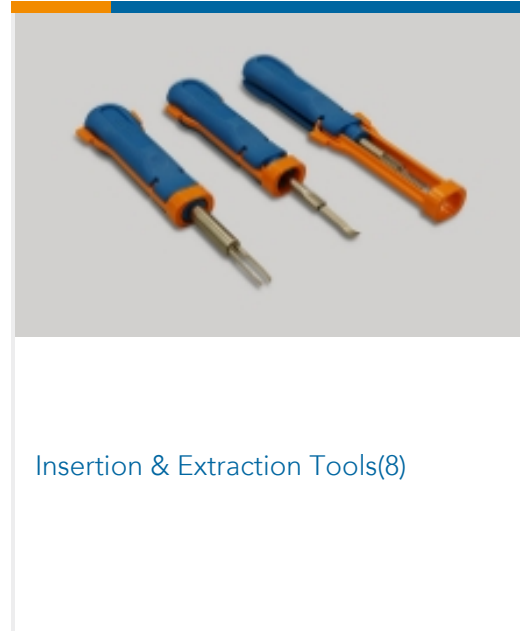

Insertion & Extraction Tools(8)

Customers Also Bought



TE Part #1423967-1
T92P7D52-24



TE Part #HDP24-24-19PE-L015
REC, 19P, BLK, E, THD, 12/16, P



TE Part #770361-1
06P .093 COMM P&S PLUG .250CL



TE Part #770372-1
06P .093 COMM P&S RECPT .250CL



TE Part #770339-1
03P .093 COMM P&S RECPT .250CL

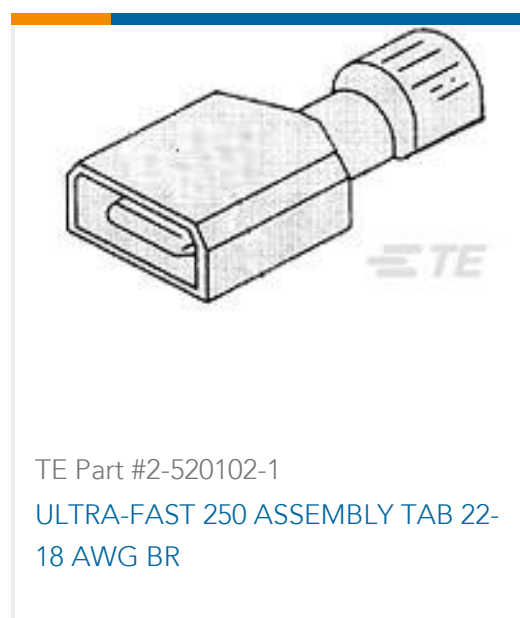

TE Part #2-520102-1
ULTRA-FAST 250 ASSEMBLY TAB 22-18 AWG BR



TE Part #2311403-4
CAP, SQ, ILLUMINATED TACT SWITCH, BLUE



TE Part #1060-12-0166
PIN, SF, SIZE 12, 12-14, NI/SN



TE Part #41616
250 FASTON TAB BR



TE Part #ANT-MAG-B85-RPS
Antenna Magnetic Base 85mm RG174 4M RPS



Documents

Product Drawings

[SOC, SF, SIZE 12, 12-14, AU/SN](#)

English

CAD Files

[3D PDF](#)

3D

Customer View Model

[ENG_CVM_CVM_1062-12-0144_E_c-1062-12-0144-e.2d_dxf.zip](#)

English

Customer View Model

[ENG_CVM_CVM_1062-12-0144_E_c-1062-12-0144-e.3d_igs.zip](#)

English

Customer View Model

[ENG_CVM_CVM_1062-12-0144_E_c-1062-12-0144-e.3d_stp.zip](#)

English

By downloading the CAD file I accept and agree to the [Terms and Conditions](#) of use.

Datasheets & Catalog Pages

[CONNECTOR SELECTOR](#)

English

Product Specifications

[Application Specification](#)

English

Product Environmental Compliance

[Product Compliance](#)

English

[Product Compliance](#)

English