

104893-5 ✓ ACTIVE

AMPMODU | AMPMODU 50/50 Grid

TE Internal #: 104893-5

Ribbon Cable Connectors, Cable-to-Board, 50 Position, 1.27 mm [.05 in] Centerline, 2 Row, Receptacle, Standard Profile, AMPMODU 50/50 Grid

[View on TE.com >](#)



Connectors > PCB Connectors > Wire-to-Board Connectors > FFC, FPC & Ribbon Connectors > Ribbon Cable Connectors

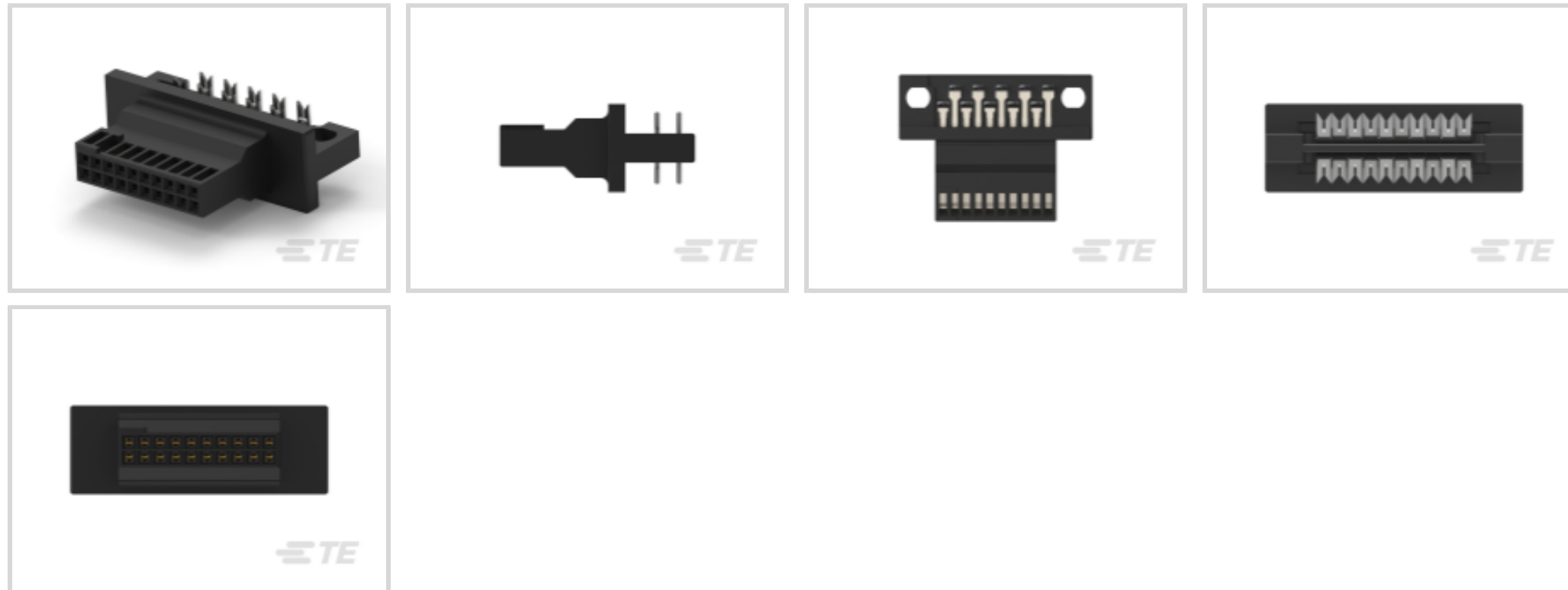

Connector System: **Cable-to-Board**

Number of Positions: **50**

Centerline (Pitch): **1.27 mm [.05 in]**

Row-to-Row Spacing: **1.27 mm [.05 in]**

Number of Rows: **2**

Features

Product Type Features

Connector Product Type	Connector Assembly
Connector System	Cable-to-Board
Connector & Housing Type	Receptacle
Connector & Contact Terminates To	Wire & Cable

Configuration Features

Number of Positions	50
Number of Rows	2

Electrical Characteristics

Insulation Resistance	5000 MΩ
Operating Voltage	30 VAC

Body Features

Primary Product Color	Black
Connector Profile	Standard



Contact Features

Contact Layout	Matrix
Mating Pin Diameter	.46 mm[.018 in]
Contact Type	Receptacle
Wire Contact Termination Area Plating Thickness	1.27 μ m[50 μ in]
Wire Contact Termination Area Plating Material	Tin
Contact Mating Area Plating Material Thickness	.762 μ m[30 μ in]
Contact Mating Area Plating Material	Gold
Contact Underplating Material	Nickel
Contact Base Material	Phosphor Bronze
Contact Current Rating (Max)	.5 A

Termination Features

Termination Method to Wire & Cable	Insulation Displacement (IDC)
------------------------------------	-------------------------------

Mechanical Attachment

Mating Alignment	With
Mating Alignment Type	Polarization
Mating Retention	Without
Connector Mounting Type	Cable Mount (Free-Hanging)

Housing Features

Housing Material	LCP (Liquid Crystal Polymer)
Centerline (Pitch)	1.27 mm[.05 in]

Dimensions

Connector Length	40.08 mm[1.578 in]
Connector Height	15.94 mm[.628 in]
Connector Width	7.21 mm[.284 in]
Wire Size	.08 – .09 mm ²
Row-to-Row Spacing	1.27 mm[.05 in]

Usage Conditions

Operating Temperature Range	-65 – 105 °C[-85 – 221 °F]
-----------------------------	----------------------------

Operation/Application

Circuit Application	Signal
---------------------	--------

Industry Standards



UL Rating	Recognized
Agency/Standard	CSA, UL
Approved Standards	CSA LR7189, UL E28476
UL Flammability Rating	UL 94V-0

Packaging Features

Packaging Quantity	12
Packaging Method	Tube

Product Compliance

[For compliance documentation, visit the product page on TE.com>](#)

EU RoHS Directive 2011/65/EU	Not Compliant
EU ELV Directive 2000/53/EC	Compliant with Exemptions
China RoHS 2 Directive MIIT Order No 32, 2016	Restricted Materials Above Threshold
EU REACH Regulation (EC) No. 1907/2006	Current ECHA Candidate List: JUNE 2023 (235) Candidate List Declared Against: JUNE 2023 (235) SVHC > Threshold: Pb (13% in Component Part) Article Safe Usage Statements: Do not eat, drink or smoke when using this product. Wash thoroughly after handling. Recycle if possible and dispose of the article by following all applicable governmental regulations relevant to your geographic location.
Halogen Content	Low Halogen - Br, Cl, F, I < 900 ppm per homogenous material. Also BFR/CFR/PVC Free
Solder Process Capability	Not applicable for solder process capability

Product Compliance Disclaimer

This information is provided based on reasonable inquiry of our suppliers and represents our current actual knowledge based on the information they provided. This information is subject to change. The part numbers that TE has identified as EU RoHS compliant have a maximum concentration of 0.1% by weight in homogenous materials for lead, hexavalent chromium, mercury, PBB, PBDE, DBP, BBP, DEHP, DIBP, and 0.01% for cadmium, or qualify for an exemption to these limits as defined in the Annexes of Directive 2011/65/EU (RoHS2). Finished electrical and electronic equipment products will be CE marked as required by Directive 2011/65/EU. Components may not be CE marked. Additionally, the part numbers that TE has identified as EU ELV compliant have a maximum concentration of 0.1% by weight in homogenous materials for lead, hexavalent chromium, and mercury, and 0.01% for cadmium, or qualify for an exemption to these limits as defined in the Annexes of Directive 2000/53/EC (ELV). Regarding the REACH Regulation, the information TE provides on SVHC in articles for this part number is based on the latest European Chemicals Agency (ECHA) 'Guidance on requirements for substances in articles' posted at this URL: <https://echa.europa.eu/guidance-documents/guidance-on-reach>

Compatible Parts

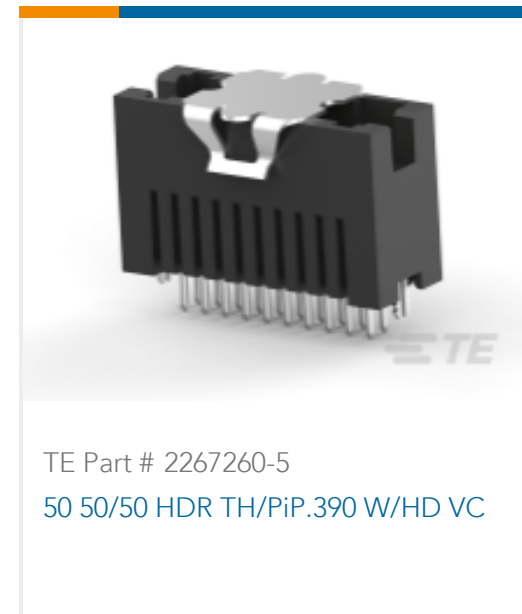
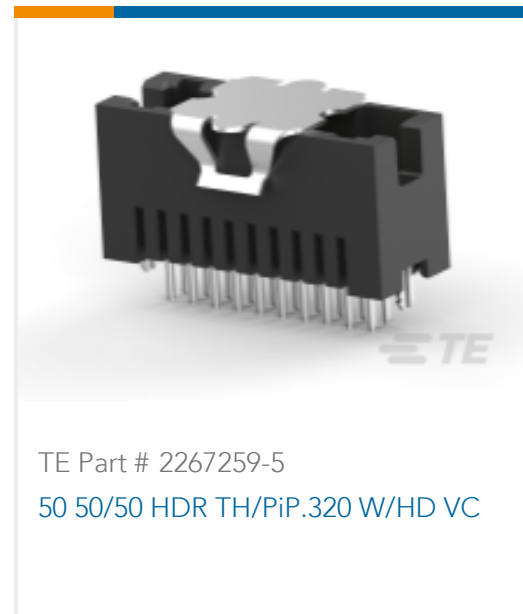

Also in the Series | **AMPMODU 50/50 Grid**

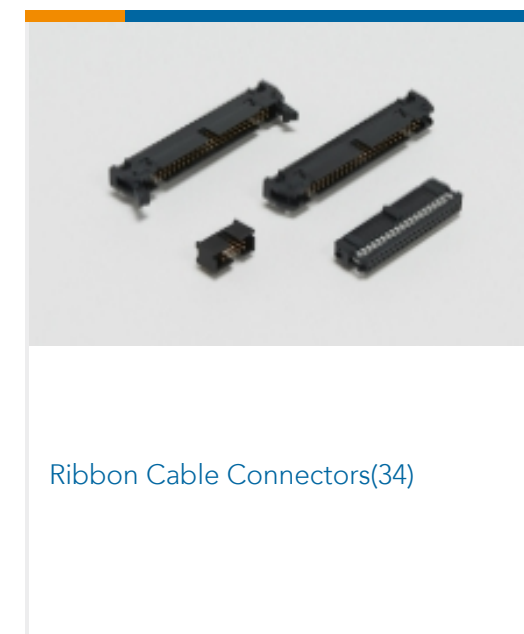
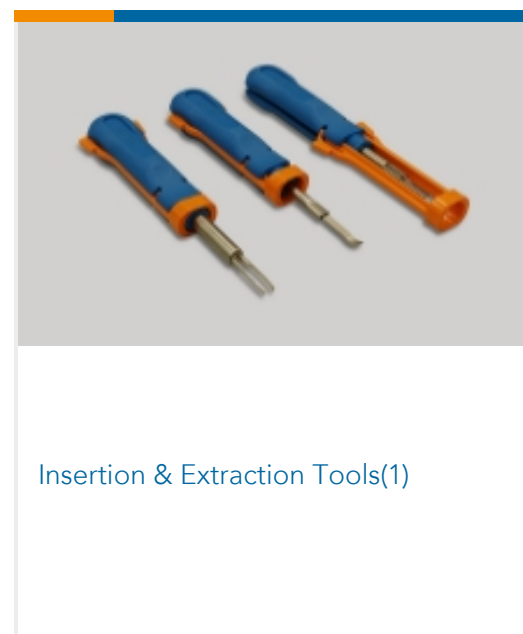
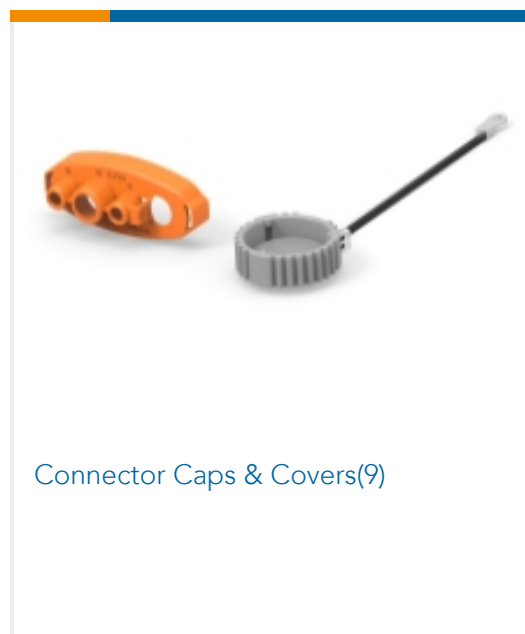

Customers Also Bought

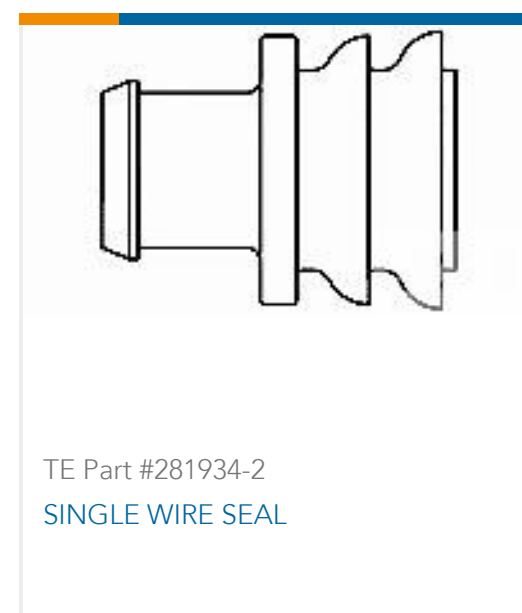



Documents

Product Drawings

[50 50/50 GRID CABLE RECPT](#)

English

CAD Files

Customer View Model

[ENG_CVM_CVM_104893-5_H.2d_dxf.zip](#)

English

3D PDF

3D

Customer View Model

[ENG_CVM_CVM_104893-5_H.3d_igs.zip](#)

English

Customer View Model

[ENG_CVM_CVM_104893-5_H.3d_stp.zip](#)

English

By downloading the CAD file I accept and agree to the [Terms and Conditions](#) of use.

Product Specifications

[Application Specification](#)

English

Product Environmental Compliance

[TE Material Declaration](#)

English

Agency Approvals

[UL Report](#)

English