

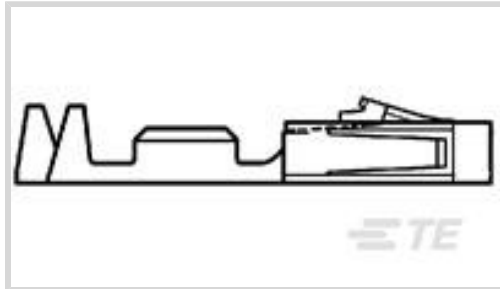

Connectors > PCB Connectors > Wire-to-Board Connectors > Wire-to-Board Connector Contacts



Contact Type: **Socket**

Connector System: **Wire-to-Board**

Wire Size: **.03 – .09 mm²**

Features

Product Type Features

Applied Pressure	Standard
Connector System	Wire-to-Board
Connector & Contact Terminates To	Wire & Cable

Configuration Features

Compatible With Wire & Cable Type	Discrete Wire
-----------------------------------	---------------

Electrical Characteristics

Termination Resistance	12 mΩ
Insulation Resistance	5000 MΩ
Dielectric Withstanding Voltage (Max)	750 V
Operating Voltage	300 VAC

Contact Features

Mating Square Post Dimension	.64 mm[.025 in]
	15 μin
Contact Base Material	Copper Alloy
Contact Type	Socket
Contact Mating Area Plating Material	Gold
Contact Current Rating (Max)	3 A

Termination Features

Termination Method to Wire & Cable	Crimp
------------------------------------	-------



Mechanical Attachment

Wire Insulation Support	With
-------------------------	------

Dimensions

Compatible Insulation Diameter Range	.64 – 1.52 mm [.025 – .06 in]
Wire Size	.03 – .09 mm ²

Usage Conditions

Operating Temperature Range	-65 – 105 °C [-85 – 221 °F]
-----------------------------	-----------------------------

Operation/Application

Circuit Application	Power & Signal
---------------------	----------------

Industry Standards

Approved Standards	CSA LR7189, UL E28476
--------------------	-----------------------

Packaging Features

Packaging Quantity	15000
Packaging Method	Reel

Product Compliance

[For compliance documentation, visit the product page on TE.com>](#)

EU RoHS Directive 2011/65/EU	Not Compliant
EU ELV Directive 2000/53/EC	Not Compliant
China RoHS 2 Directive MIIT Order No 32, 2016	Restricted Materials Above Threshold
EU REACH Regulation (EC) No. 1907/2006	Current ECHA Candidate List: JUNE 2023 (235) Candidate List Declared Against: JUNE 2023 (235) SVHC > Threshold: Pb (13% in Component Part) Article Safe Usage Statements: Do not eat, drink or smoke when using this product. Wash thoroughly after handling. Recycle if possible and dispose of the article by following all applicable governmental regulations relevant to your geographic location.
Halogen Content	Low Halogen - Br, Cl, F, I < 900 ppm per homogenous material. Also BFR/CFR/PVC Free
Solder Process Capability	Not applicable for solder process capability

Product Compliance Disclaimer

This information is provided based on reasonable inquiry of our suppliers and represents our current actual knowledge based on the information they provided. This information is subject to change. The part numbers that TE has identified as EU RoHS compliant have a maximum concentration of 0.1% by weight in homogenous materials for lead, hexavalent

chromium, mercury, PBB, PBDE, DBP, BBP, DEHP, DIBP, and 0.01% for cadmium, or qualify for an exemption to these limits as defined in the Annexes of Directive 2011/65/EU (RoHS2). Finished electrical and electronic equipment products will be CE marked as required by Directive 2011/65/EU. Components may not be CE marked. Additionally, the part numbers that TE has identified as EU ELV compliant have a maximum concentration of 0.1% by weight in homogenous materials for lead, hexavalent chromium, and mercury, and 0.01% for cadmium, or qualify for an exemption to these limits as defined in the Annexes of Directive 2000/53/EC (ELV). Regarding the REACH Regulation, the information TE provides on SVHC in articles for this part number is based on the latest European Chemicals Agency (ECHA) 'Guidance on requirements for substances in articles' posted at this URL: <https://echa.europa.eu/guidance-documents/guidance-on-reach>

Compatible Parts



TE Part # 91518-1
CCII AMPMODU SHORT POINT REC
32-22 ASSY



TE Part # 843477-1
TOOL, EXTRACTION RESET



TE Part # 2-2836129-2
OCEAN_2.0_APPLICATOR-S-
033F055O



TE Part # 2836129-2
OCEAN_2.0_APPLICATOR-S-
033F055O



TE Part # 7-2836129-2
OCEAN_2.0_APPLICATOR-S-
033F055O



TE Part # 7-2836129-7
OCEAN_2.0_SPARE_PART_KIT-
033F055O

Also in the Series | AMPMODU IV/V



Automotive Housings(2)

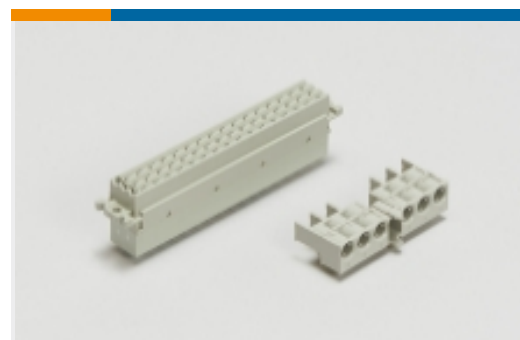

Backplane Connector Housings(1)



Board-to-Board Connector Contacts(6)



Connector Strain Relief(3)



Insertion & Extraction Tools(4)



PCB Connector Covers(18)



PCB Connector Keying(6)



PCB Connector Mounting(1)



PCB Headers & Receptacles(934)



PCB Latches, Locks & Retainers(7)



Rectangular Connector Housings(5)



Standard Rectangular Connectors(8)



Wire-to-Board Connector Assemblies & Housings(447)



Wire-to-Board Connector Contacts (322)

Customers Also Bought



TE Part #208492-1
PLUG ASSY,SZ 22,CMC



TE Part #61314-6
CMNL SOK S/F 24-18 .0125AUPHBZ

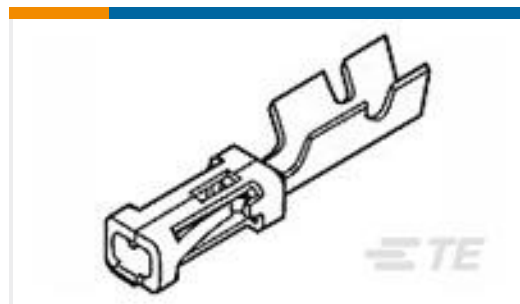

TE Part #103455-2
MOD V RECP LP



TE Part #1825219-6
TT11EGPC104



TE Part #CM9614-000
SBP100143WE5



TE Part #390088-1
BLACK HSG WITH 30AU CONTACT



TE Part #2150041-2
OCEAN_2.0_Applicator-E-110F180F



TE Part #2151314-1
OCEAN_2.0_Applicator-S-110F155F



TE Part #2837605-1
OCEAN-2.0-APPLICATOR-S-112O160F



TE Part #466779-6
APPL,HDM 5SAPR176D G

Documents



Product Drawings

SHORT POINT CONT 15 DPLX STMPD

English

CAD Files

Customer View Model

[ENG_CVM_104481-3_N.2d_dxf.zip](#)

English

3D PDF

English

Customer View Model

[ENG_CVM_104481-3_N.3d_igs.zip](#)

English

Customer View Model

[ENG_CVM_104481-3_N.3d_stp.zip](#)

English

By downloading the CAD file I accept and agree to the [Terms and Conditions](#) of use.

Product Specifications

[Application Specification](#)

English

Product Environmental Compliance

[TE Material Declaration](#)

English