

104422-1 ✓ ACTIVE

AMPMODU | AMPMODU IV/V

TE Internal #: 104422-1

Housing, Receptacle, Wire-to-Board, 16 Position, .1 in [2.54 mm]
Centerline, Crimp, 2 Row, Black, Mating Retention, Wire & Cable,
Signal, AMPMODU IV/V

[View on TE.com >](#)



Connectors > PCB Connectors > Wire-to-Board Connectors > Wire-to-Board Connector Assemblies & Housings

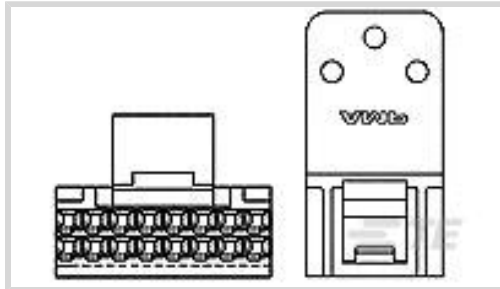

Connector Product Type: **Housing**

Connector & Housing Type: **Receptacle**

Connector System: **Wire-to-Board**

Number of Positions: **16**

Centerline (Pitch): **2.54 mm [.1 in]**

Features

Product Type Features

Connector Product Type	Housing
Connector & Housing Type	Receptacle
Connector System	Wire-to-Board
Connector & Contact Terminates To	Wire & Cable

Configuration Features

Number of Positions	16
Number of Rows	2

Electrical Characteristics

Dielectric Withstanding Voltage (Max)	750 VAC
Insulation Resistance	5000 MΩ
Operating Voltage	267 V

Body Features

Primary Product Color	Black
-----------------------	-------

Contact Features

Contact Type	Socket
Contact Current Rating (Max)	3 A

Termination Features

Termination Method to Wire & Cable	Crimp
------------------------------------	-------



Mechanical Attachment

Strain Relief	With
Panel Mount Feature	Without
PCB Mount Retention	Without
Mating Retention	With

Housing Features

Housing Entry Configuration	Both Ends Closed
Housing Material	Thermoplastic
Centerline (Pitch)	2.54 mm[.1 in]

Dimensions

Connector Length	20.32 mm[.8 in]
Connector Height	8.51 mm[.335 in]
Row-to-Row Spacing	2.54 mm[.1 in]

Usage Conditions

Operating Temperature Range	-65 – 105 °C[-85 – 221 °F]
-----------------------------	----------------------------

Operation/Application

Circuit Application	Signal
---------------------	--------

Industry Standards

Glow Wire Rating	Standard Part - Not Glow Wire
------------------	-------------------------------

Packaging Features

Packaging Quantity	500
Packaging Method	Bag

Product Compliance

[For compliance documentation, visit the product page on TE.com>](#)

EU RoHS Directive 2011/65/EU	Compliant
EU ELV Directive 2000/53/EC	Compliant
China RoHS 2 Directive MIIT Order No 32, 2016	No Restricted Materials Above Threshold
EU REACH Regulation (EC) No. 1907/2006	Current ECHA Candidate List: JUNE 2023 (235) Candidate List Declared Against: JUNE 2023 (235) Does not contain REACH SVHC



Halogen Content	Low Halogen - Br, Cl, F, I < 900 ppm per homogenous material. Also BFR/CFR/PVC Free
Solder Process Capability	Not applicable for solder process capability

Product Compliance Disclaimer

This information is provided based on reasonable inquiry of our suppliers and represents our current actual knowledge based on the information they provided. This information is subject to change. The part numbers that TE has identified as EU RoHS compliant have a maximum concentration of 0.1% by weight in homogenous materials for lead, hexavalent chromium, mercury, PBB, PBDE, DBP, BBP, DEHP, DIBP, and 0.01% for cadmium, or qualify for an exemption to these limits as defined in the Annexes of Directive 2011/65/EU (RoHS2). Finished electrical and electronic equipment products will be CE marked as required by Directive 2011/65/EU. Components may not be CE marked. Additionally, the part numbers that TE has identified as EU ELV compliant have a maximum concentration of 0.1% by weight in homogenous materials for lead, hexavalent chromium, and mercury, and 0.01% for cadmium, or qualify for an exemption to these limits as defined in the Annexes of Directive 2000/53/EC (ELV). Regarding the REACH Regulation, the information TE provides on SVHC in articles for this part number is based on the latest European Chemicals Agency (ECHA) 'Guidance on requirements for substances in articles' posted at this URL: <https://echa.europa.eu/guidance-documents/guidance-on-reach>

Compatible Parts



Also in the Series | AMPMODU IV/V

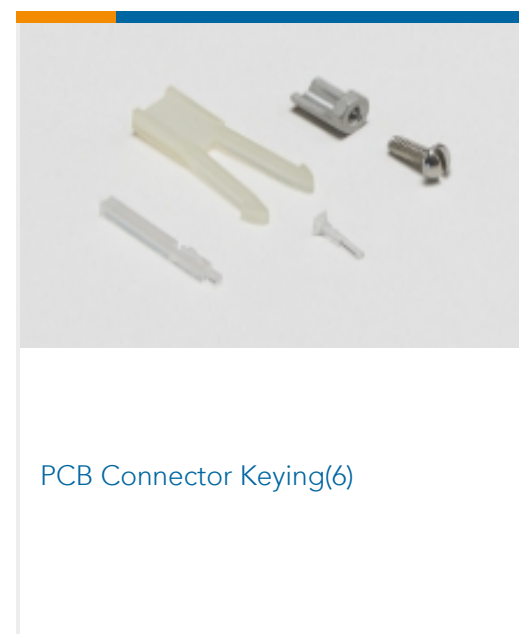
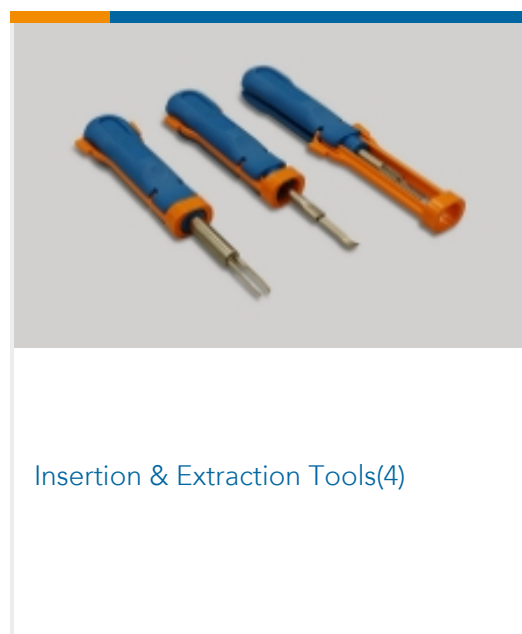
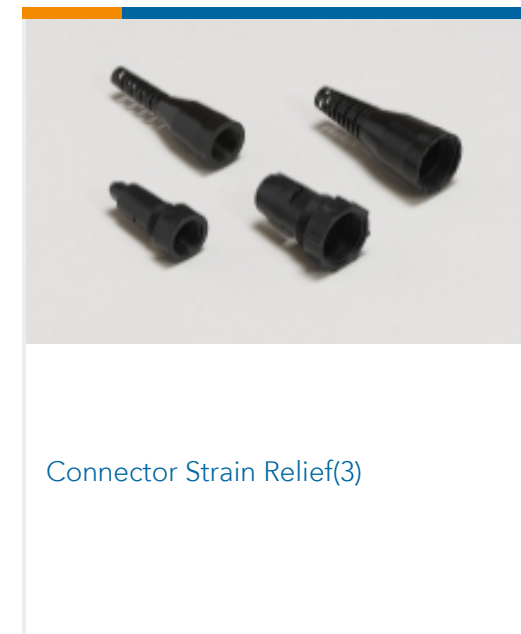
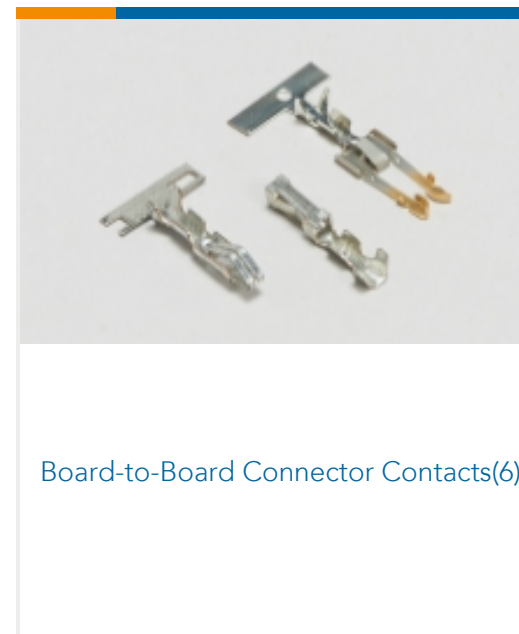
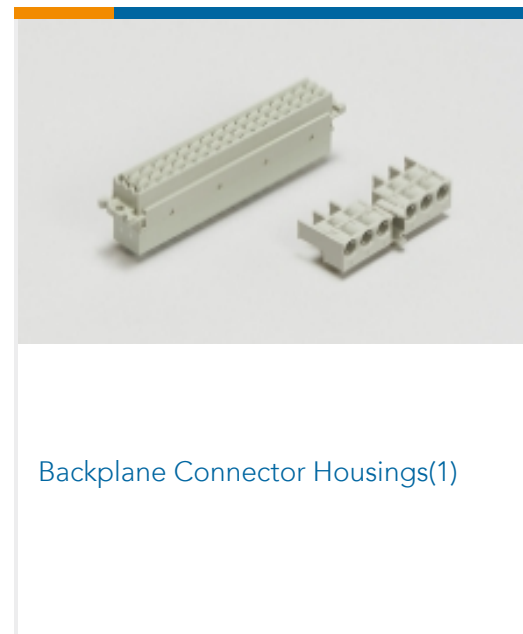
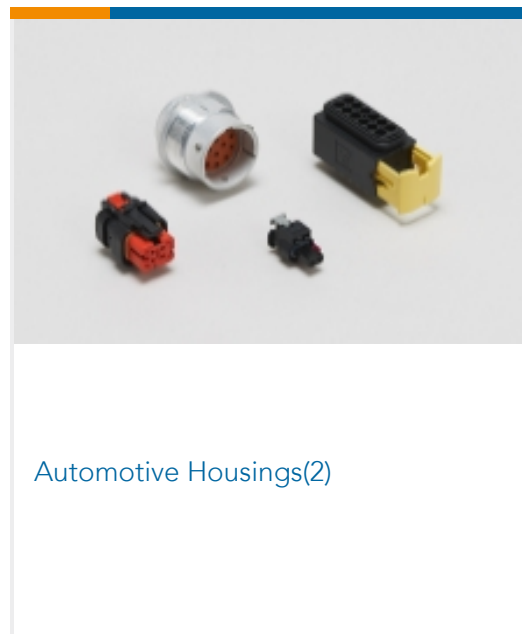



PCB Headers & Receptacles(934)



PCB Latches, Locks & Retainers(7)



Rectangular Connector Housings(5)



Standard Rectangular Connectors(8)



Wire-to-Board Connector Assemblies & Housings(447)



Wire-to-Board Connector Contacts (322)

Customers Also Bought



TE Part #323008
PIDG R 22-16 COMM 22-18 MIL 6



TE Part #281838-5
HOUSING HE13 HE14 COSI 5 P

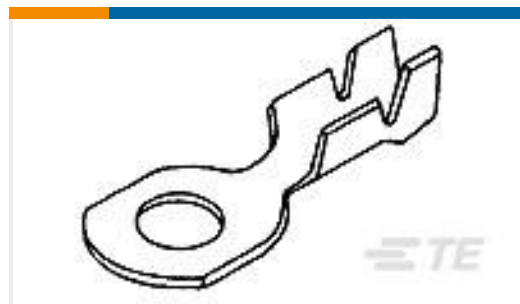

TE Part #60123-2
RING 160 CRIMP TAB 26-20 AWG
TPBR

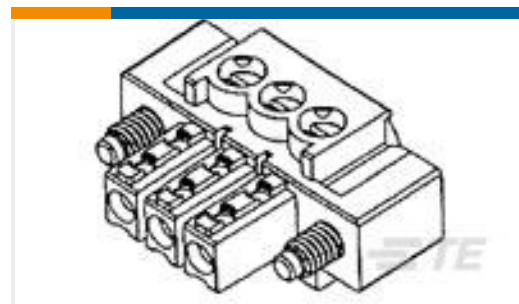

TE Part #284510-8
8P TERMI-BLOK PLUG CON VITI



TE Part #1534805-1
HD20 COVER KIT 9POS WITH CABLE



TE Part #4-174639-0
1.25FP,R10,DL,B,N,BG

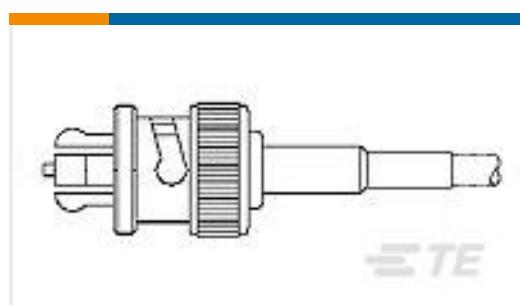

TE Part #51426-2
SAFE HIGH VOLTAGE PLUG



TE Part #119945-E
IBRFCT VE C2224 1 REEL J 3 119944



TE Part #119983-E
IBRCMP RET 04 VE 208 BAG J 3
119980 IBRI

Documents



Product Drawings

16 MOD IV HSG COMP W/LATCH POL

English

CAD Files

3D PDF

3D

Customer View Model

[ENG_CVM_CVM_104422-1_U.2d_dxf.zip](#)

English

Customer View Model

[ENG_CVM_CVM_104422-1_U.3d_igs.zip](#)

English

Customer View Model

[ENG_CVM_CVM_104422-1_U.3d_stp.zip](#)

English

3D PDF

English

Customer View Model

[ENG_CVM_104422-1_H.2d_dxf.zip](#)

English

Customer View Model

[ENG_CVM_104422-1_H.3d_igs.zip](#)

English

Customer View Model

[ENG_CVM_104422-1_H.3d_stp.zip](#)

English

By downloading the CAD file I accept and agree to the [Terms and Conditions](#) of use.

Product Specifications

Product Specification

English

Product Environmental Compliance

TE Material Declaration

English