

103682-1 ✓ ACTIVE

AMPMODU | AMPMODU MTE

TE Internal #: 103682-1

Panel Mount Shroud, Black, Thermoplastic, 2 Position, AMPMODU MTE

[View on TE.com >](#)



Connectors > Connector Accessories > Connector Caps & Covers



Connector Cover Type: **Panel Mount Shroud**

Primary Product Color: **Black**

Primary Product Material: **Thermoplastic**

Number of Positions: **2**

Operating Temperature (Max): **105 °C [ 221 °F ]**

## Features

### Product Type Features

Connector Cover Type	Panel Mount Shroud
----------------------	--------------------

### Configuration Features

Number of Rows	1
Number of Positions	2

### Body Features

Primary Product Color	Black
Primary Product Material	Thermoplastic

### Mechanical Attachment

Mating Alignment Type	Latched
Mating Alignment	With

### Dimensions

Product Width	25.15 mm[.99 in]
Product Length	18.67 mm[.73 in]
Product Height	6.35 mm[.25 in]

### Usage Conditions

Operating Temperature (Max)	105 °C[221 °F]
Operating Temperature Range	-65 – 105 °C[-85 – 221 °F]

### Industry Standards

UL Flammability Rating	UL 94V-0
------------------------	----------

### Packaging Features

Packaging Method	Package
------------------	---------

### Other

Connector Accessory Comment	Insert Pin Receptacle Assembly w/Guide Ribs (only) into shroud.
-----------------------------	---

### Product Compliance

[For compliance documentation, visit the product page on TE.com>](#)

EU RoHS Directive 2011/65/EU	Compliant
EU ELV Directive 2000/53/EC	Compliant
China RoHS 2 Directive MIIT Order No 32, 2016	No Restricted Materials Above Threshold
EU REACH Regulation (EC) No. 1907/2006	Current ECHA Candidate List: JUNE 2023 (235) Candidate List Declared Against: JUNE 2023 (235) Does not contain REACH SVHC
Halogen Content	BFR/CFR/PVC Free, but Br/Cl >900 ppm in other sources.
Solder Process Capability	Not applicable for solder process capability

#### Product Compliance Disclaimer

This information is provided based on reasonable inquiry of our suppliers and represents our current actual knowledge based on the information they provided. This information is subject to change. The part numbers that TE has identified as EU RoHS compliant have a maximum concentration of 0.1% by weight in homogenous materials for lead, hexavalent chromium, mercury, PBB, PBDE, DBP, BBP, DEHP, DIBP, and 0.01% for cadmium, or qualify for an exemption to these limits as defined in the Annexes of Directive 2011/65/EU (RoHS2). Finished electrical and electronic equipment products will be CE marked as required by Directive 2011/65/EU. Components may not be CE marked. Additionally, the part numbers that TE has identified as EU ELV compliant have a maximum concentration of 0.1% by weight in homogenous materials for lead, hexavalent chromium, and mercury, and 0.01% for cadmium, or qualify for an exemption to these limits as defined in the Annexes of Directive 2000/53/EC (ELV). Regarding the REACH Regulation, the information TE provides on SVHC in articles for this part number is based on the latest European Chemicals Agency (ECHA) 'Guidance on requirements for substances in articles' posted at this URL: <https://echa.europa.eu/guidance-documents/guidance-on-reach>

### Compatible Parts



## Also in the Series | AMPMODU MTE

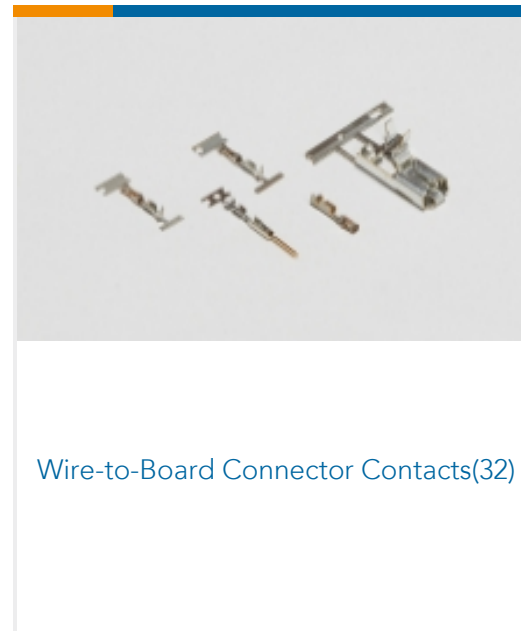
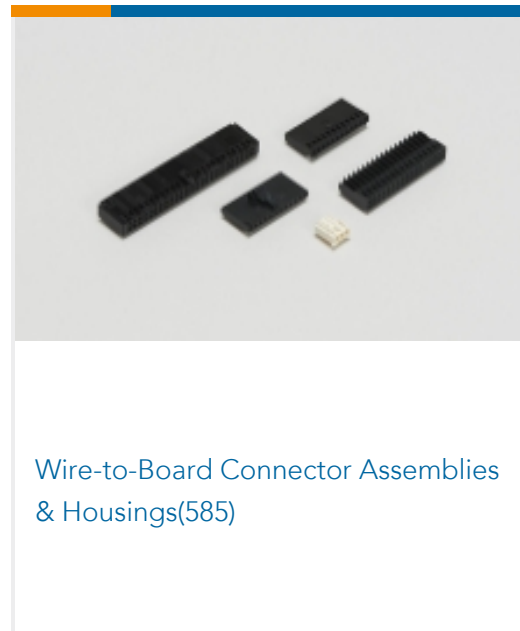
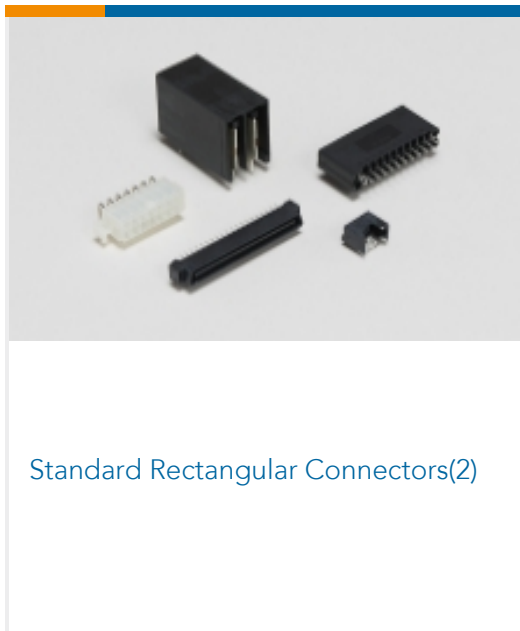
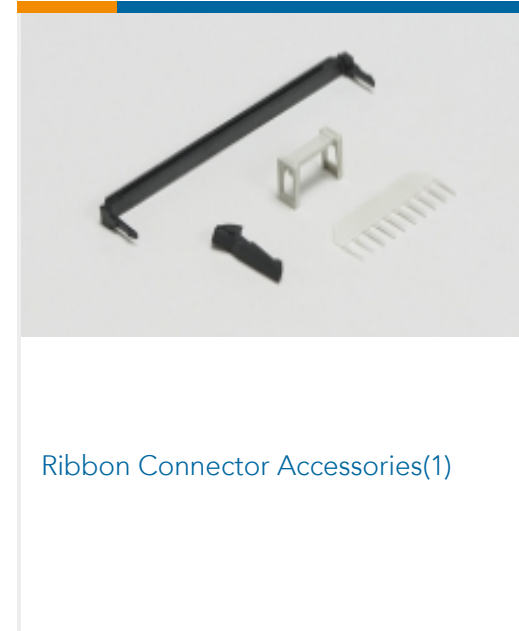
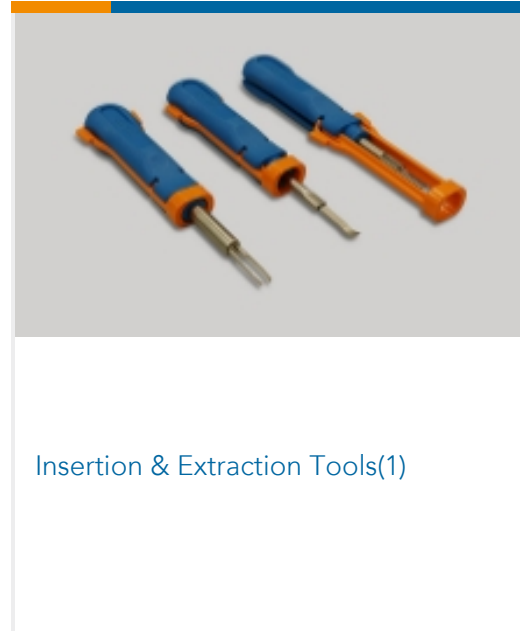
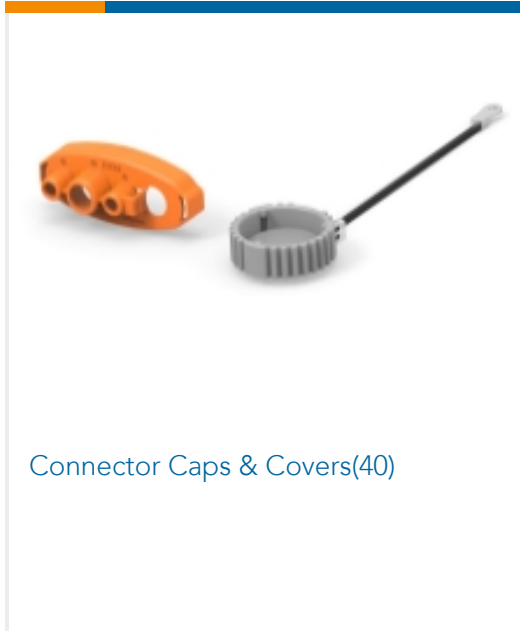

## Customers Also Bought

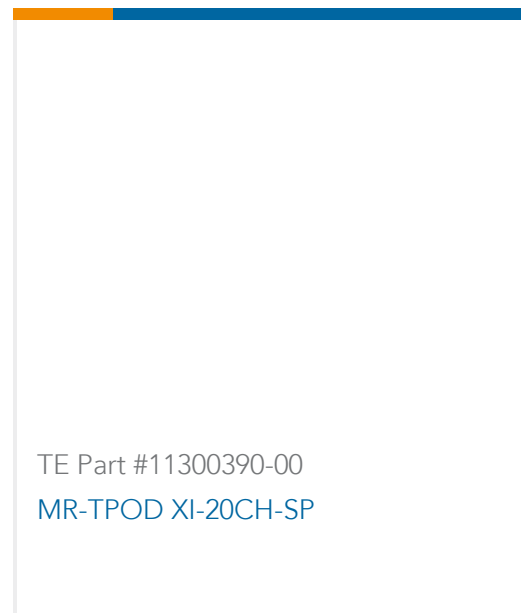
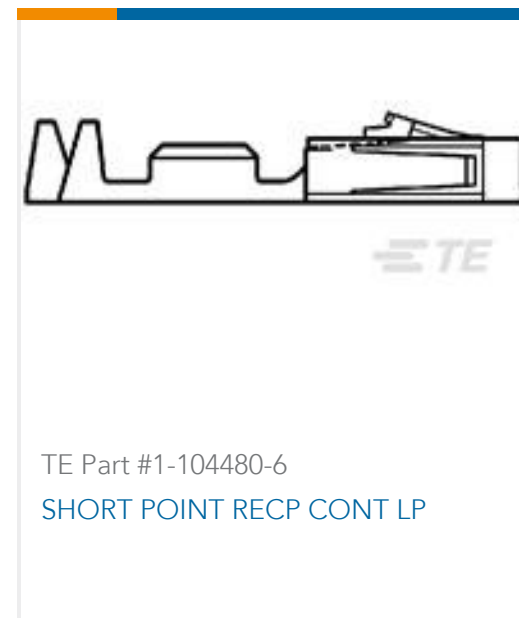

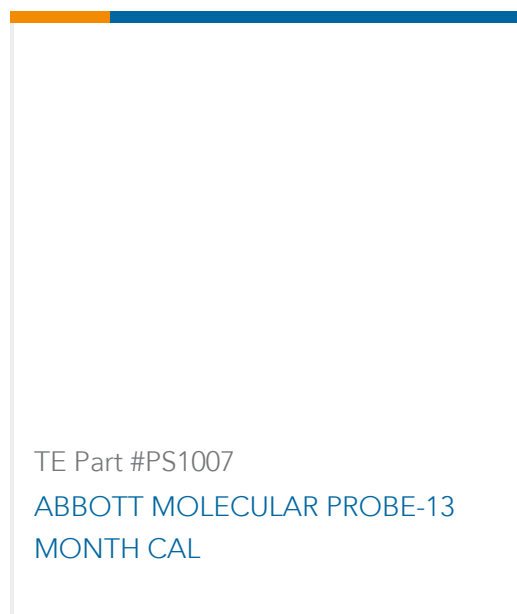

## Documents

### Product Drawings

[02 MTE PANEL MOUNT SR](#)

English

### CAD Files

Customer View Model

[ENG\\_CVM\\_CVM\\_103682-1\\_N.2d\\_dxf.zip](#)

English

[3D PDF](#)

3D

Customer View Model

[ENG\\_CVM\\_CVM\\_103682-1\\_N.3d\\_igs.zip](#)

English

Customer View Model

[ENG\\_CVM\\_CVM\\_103682-1\\_N.3d\\_stp.zip](#)

English

By downloading the CAD file I accept and agree to the [Terms and Conditions](#) of use.

### Datasheets & Catalog Pages

[AMP MODU MTE Section of Catalog 1307819](#)

English

[AMPMODU\\_INTERCONNECTION\\_SYSTEM\\_SECTION5\\_CONT](#)

English

[AMPMODU MTE INTERCONNECT SYSTEM](#)

English

### Product Specifications

[Application Specification](#)

English

### Instruction Sheets

[Instruction Sheet \(U.S.\)](#)

English