

103673-2 ✓ ACTIVE

AMPMODU | AMPMODU MTE

TE Internal #: 103673-2

PCB Mount Header, Right Angle, Wire-to-Board, 3 Position, 2.54 mm [.1 in] Centerline, Fully Shrouded, Gold, Through Hole - Solder, Signal, AMPMODU MTE

[View on TE.com >](#)



Connectors > PCB Connectors > PCB Headers & Receptacles

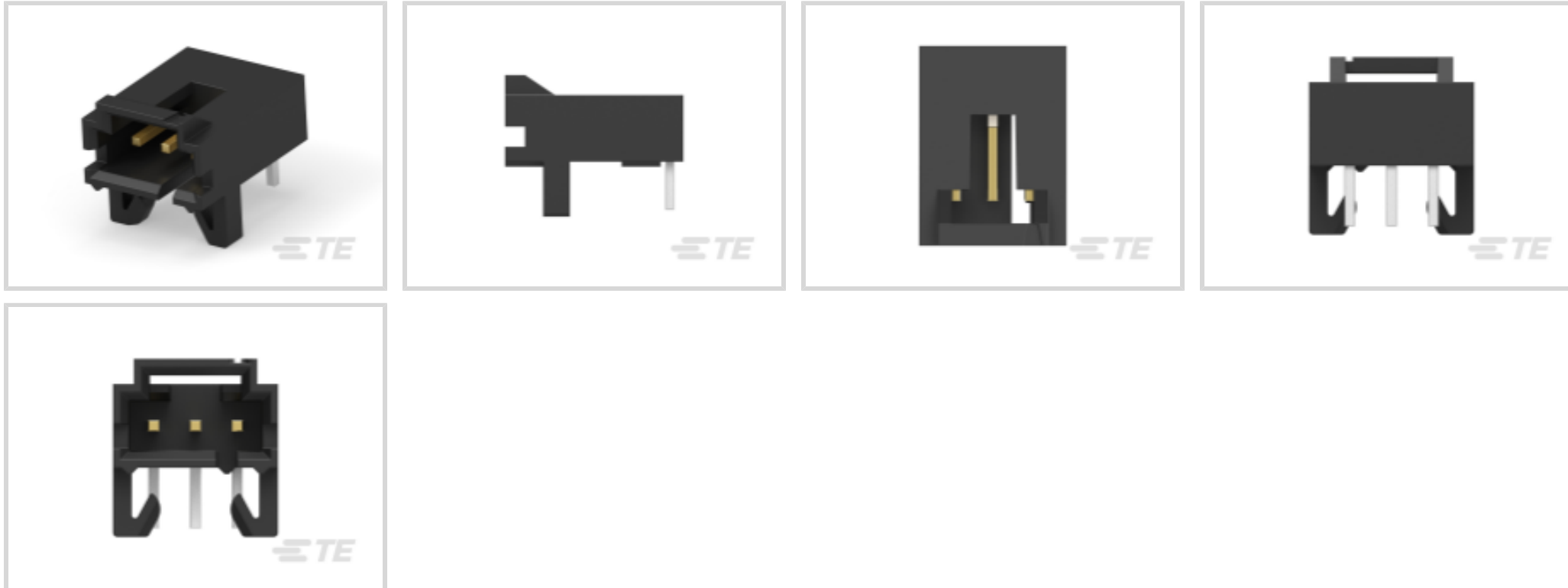

Connector System: **Wire-to-Board**

Number of Positions: **3**

Number of Rows: **1**

Centerline (Pitch): **2.54 mm [.1 in]**

PCB Mount Orientation: **Right Angle**

Features

Product Type Features

Connector System	Wire-to-Board
Header Type	Fully Shrouded
Sealable	No
Connector & Contact Terminates To	Printed Circuit Board
PCB Connector Assembly Type	PCB Mount Header

Configuration Features

Number of Positions	3
Number of Rows	1
PCB Mount Orientation	Right Angle

Electrical Characteristics

Termination Resistance	15 mΩ
Insulation Resistance	5000 MΩ
Dielectric Withstanding Voltage (Max)	600 V

Body Features



Primary Product Color	Black
-----------------------	-------

Contact Features

Contact Mating Area Length	5.84 mm[.23 in]
----------------------------	-----------------

Mating Square Post Dimension	.64 mm[.025 in]
------------------------------	-----------------

PCB Contact Termination Area Plating Material Thickness	2.54 μ m[100 μ in]
---	----------------------------

Contact Mating Area Plating Material Thickness	.381 μ m[15 μ in]
--	---------------------------

PCB Contact Termination Area Plating Material Finish	Matte
--	-------

Contact Shape & Form	Square
----------------------	--------

PCB Contact Termination Area Plating Material	Tin-Lead
---	----------

Contact Base Material	Brass
-----------------------	-------

Contact Mating Area Plating Material	Gold
--------------------------------------	------

Contact Type	Pin
--------------	-----

Contact Current Rating (Max)	3 A
------------------------------	-----

Termination Features

Square Termination Post & Tail Dimension	.64 mm[.025 in]
--	-----------------

Termination Post & Tail Length	3.3 mm[.13 in]
--------------------------------	----------------

Termination Method to Printed Circuit Board	Through Hole - Solder
---	-----------------------

Mechanical Attachment

Mating Alignment Type	Latched, Polarization
-----------------------	-----------------------

Mating Retention	With
------------------	------

PCB Mount Retention Type	Hold-Down
--------------------------	-----------

Mating Retention Type	Hold-Down
-----------------------	-----------

Connector Mounting Type	Board Mount
-------------------------	-------------

Mating Alignment	With
------------------	------

PCB Mount Alignment	Without
---------------------	---------

PCB Mount Retention	With
---------------------	------

Housing Features

Housing Material	Thermoplastic
------------------	---------------

Centerline (Pitch)	2.54 mm[.1 in]
--------------------	----------------

Dimensions

Connector Length	10.16 mm[.4 in]
------------------	-----------------

Connector Height	6.99 mm[.275 in]
------------------	------------------



PCB Thickness (Recommended)	1.57 mm[.062 in]
-----------------------------	------------------

Usage Conditions

Operating Temperature Range	-65 – 105 °C[-85 – 221 °F]
-----------------------------	----------------------------

Operation/Application

Circuit Application	Signal
---------------------	--------

Industry Standards

Approved Standards	CSA LR7189, UL E28476
--------------------	-----------------------

UL Flammability Rating	UL 94V-0
------------------------	----------

Packaging Features

Packaging Quantity	52
--------------------	----

Packaging Type	Box, Tube
----------------	-----------

Product Compliance

[For compliance documentation, visit the product page on TE.com>](#)

EU RoHS Directive 2011/65/EU	Not Compliant
------------------------------	---------------

EU ELV Directive 2000/53/EC	Compliant with Exemptions
-----------------------------	---------------------------

China RoHS 2 Directive MIIT Order No 32, 2016	Restricted Materials Above Threshold
---	--------------------------------------

EU REACH Regulation (EC) No. 1907/2006	<p>Current ECHA Candidate List: JUNE 2023 (235) Candidate List Declared Against: JUNE 2023 (235) SVHC > Threshold: Pb (13% in Component Part)</p>
--	---

Article Safe Usage Statements:
Do not eat, drink or smoke when using this product. Wash thoroughly after handling. Recycle if possible and dispose of the article by following all applicable governmental regulations relevant to your geographic location.

Halogen Content	Low Halogen - Br, Cl, F, I < 900 ppm per homogenous material. Also BFR/CFR/PVC Free
-----------------	---

Solder Process Capability	Reflow solder capable to 260°C
---------------------------	--------------------------------

Product Compliance Disclaimer

This information is provided based on reasonable inquiry of our suppliers and represents our current actual knowledge based on the information they provided. This information is subject to change. The part numbers that TE has identified as EU RoHS compliant have a maximum concentration of 0.1% by weight in homogenous materials for lead, hexavalent chromium, mercury, PBB, PBDE, DBP, BBP, DEHP, DIBP, and 0.01% for cadmium, or qualify for an exemption to these limits as defined in the Annexes of Directive 2011/65/EU (RoHS2). Finished electrical and electronic equipment products will be CE marked as required by Directive 2011/65/EU. Components may not be CE marked. Additionally, the part numbers that TE has identified as EU ELV compliant have a maximum concentration of 0.1% by weight in homogenous materials for lead, hexavalent chromium, and mercury, and 0.01% for cadmium, or qualify for an exemption to these limits as defined in the Annexes of Directive 2000/53/EC (ELV). Regarding the REACH Regulation, the information TE provides on SVHC in articles for this part number is based on the latest European Chemicals Agency (ECHA) 'Guidance on

requirements for substances in articles' posted at this URL: <https://echa.europa.eu/guidance-documents/guidance-on-reach>

Compatible Parts



TE Part # 487526-2
003 HOUSING FFC RCPT 100CL SR



TE Part # 103957-2
8X3 MTE RCPT SR LATCH .100CL



TE Part # 103972-2
8X3 MTE RCPT SR RIBBED .100CL



TE Part # 103960-2
8X3 MTE RCPT SR LATCH .100CL

Also in the Series | AMPMODU MTE



Insertion & Extraction Tools(1)



PCB Connector Shrouds(40)



PCB Headers & Receptacles(763)



Ribbon Connector Accessories(1)



Standard Rectangular Connectors(2)



Wire-to-Board Connector Assemblies & Housings(585)



Wire-to-Board Connector Contacts(32)

Customers Also Bought



TE Part #1658607-1
IDC D-Sub: Plug Assembly, Low Profile, Signal, 2.77 mm



TE Part #1658610-4
09 POS HDF RCPT, MS, LEAD FREE



TE Part #5-104078-2
40 SYSTEM 50 RCPT ASSY DRST SN



TE Part #1-104479-3
SHORT POINT RECP CONT LP



Documents

CAD Files

3D PDF

3D

Customer View Model

[ENG_CVM_CVM_103673-2_AH.2d_dxf.zip](#)

English

Customer View Model

[ENG_CVM_CVM_103673-2_AH.3d_igs.zip](#)

English

Customer View Model

[ENG_CVM_CVM_103673-2_AH.3d_stp.zip](#)

English

By downloading the CAD file I accept and agree to the [Terms and Conditions](#) of use.

Datasheets & Catalog Pages

[AMPMODU MTE INTERCONNECT SYSTEM](#)

English

Product Specifications

[Application Specification](#)

English

Product Environmental Compliance

[TE Material Declaration](#)

English

Instruction Sheets

[Instruction Sheet \(U.S.\)](#)

103673-2

PCB Mount Header, Right Angle, Wire-to-Board, 3 Position, 2.54 mm [.1 in]
Centerline, Fully Shrouded, Gold, Through Hole - Solder, Signal, AMPMODU MTE



English