



Connectors > PCB Connectors > Wire-to-Board Connectors > Wire-to-Board Connector Assemblies & Housings



Connector Product Type: **Housing**

Connector & Housing Type: **Receptacle**

Connector System: **Wire-to-Board**

Number of Positions: **4**

Centerline (Pitch): **2.54 mm [.1 in]**

Features

Product Type Features

Connector Product Type	Housing
Connector & Housing Type	Receptacle
Connector System	Wire-to-Board
Connector & Contact Terminates To	Wire & Cable

Configuration Features

Number of Positions	4
Number of Rows	1

Electrical Characteristics

Termination Resistance	12 mΩ
Insulation Resistance	5000 MΩ
Dielectric Withstanding Voltage (Max)	750 V
Operating Voltage	250 VAC

Body Features

Primary Product Color	Black
-----------------------	-------



Contact Features

Contact Layout	Inline
Contact Type	Socket
Contact Base Material	Beryllium Copper
Contact Current Rating (Max)	3 A

Termination Features

Termination Method to Wire & Cable	Crimp
------------------------------------	-------

Mechanical Attachment

Strain Relief	Without
Mating Retention Type	Detent Latching
Mating Retention	With

Housing Features

Housing Entry Configuration	Both Ends Closed
Housing Material	Nylon - GF
Centerline (Pitch)	2.54 mm[.1 in]

Dimensions

Connector Length	10.16 mm[.4 in]
Connector Height	4.62 mm[.182 in]

Usage Conditions

Operating Temperature Range	-65 – 105 °C[-85 – 221 °F]
-----------------------------	----------------------------

Operation/Application

Circuit Application	Signal
---------------------	--------

Industry Standards

Glow Wire Rating	Standard Part - Not Glow Wire
Approved Standards	CSA LR7189, UL E28476
UL Flammability Rating	UL 94V-0

Packaging Features

Packaging Quantity	1
Packaging Method	Package

Product Compliance

For compliance documentation, visit the product page on [TE.com](https://www.te.com)>



EU RoHS Directive 2011/65/EU	Compliant
EU ELV Directive 2000/53/EC	Compliant
China RoHS 2 Directive MIIT Order No 32, 2016	No Restricted Materials Above Threshold
EU REACH Regulation (EC) No. 1907/2006	Current ECHA Candidate List: JUNE 2023 (235) Candidate List Declared Against: JUNE 2023 (235) Does not contain REACH SVHC
Halogen Content	BFR/CFR/PVC Free, but Br/Cl >900 ppm in other sources.
Solder Process Capability	Not applicable for solder process capability

Product Compliance Disclaimer

This information is provided based on reasonable inquiry of our suppliers and represents our current actual knowledge based on the information they provided. This information is subject to change. The part numbers that TE has identified as EU RoHS compliant have a maximum concentration of 0.1% by weight in homogenous materials for lead, hexavalent chromium, mercury, PBB, PBDE, DBP, BBP, DEHP, DIBP, and 0.01% for cadmium, or qualify for an exemption to these limits as defined in the Annexes of Directive 2011/65/EU (RoHS2). Finished electrical and electronic equipment products will be CE marked as required by Directive 2011/65/EU. Components may not be CE marked. Additionally, the part numbers that TE has identified as EU ELV compliant have a maximum concentration of 0.1% by weight in homogenous materials for lead, hexavalent chromium, and mercury, and 0.01% for cadmium, or qualify for an exemption to these limits as defined in the Annexes of Directive 2000/53/EC (ELV). Regarding the REACH Regulation, the information TE provides on SVHC in articles for this part number is based on the latest European Chemicals Agency (ECHA) 'Guidance on requirements for substances in articles' posted at this URL: <https://echa.europa.eu/guidance-documents/guidance-on-reach>

Compatible Parts

 <p>TE Part # 87666-2 MOD IV RECP PLTD 30 SEL</p>	 <p>TE Part # 6-87756-7 MOD IV REC STP INT'L SPEC REEL</p>	 <p>TE Part # 87756-6 MOD IV RECP PLTD SN</p>	 <p>TE Part # 2-87195-4 MOD IV RECP PLTE 15 DPLX</p>
 <p>TE Part # 87809-1 MOD V RECP PLTD 30 AU</p>	 <p>TE Part # 87309-9 MOD V RECP PLTD 30 AU</p>	 <p>TE Part # 102917-5 MOD IV RECP PLTD 15 SEL</p>	 <p>TE Part # 87523-5 MOD IV RECP PLTD SN</p>

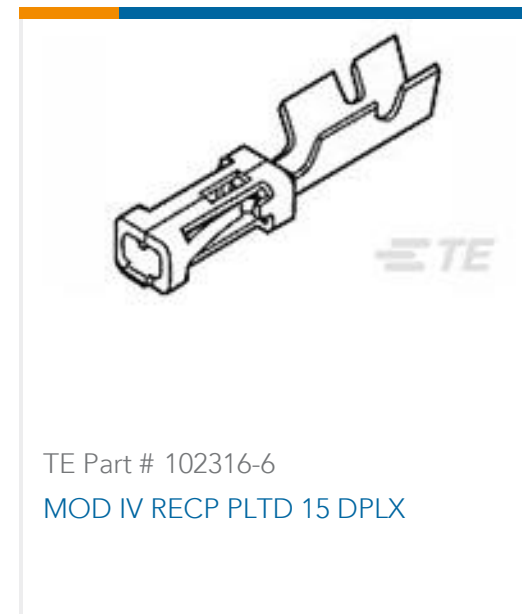
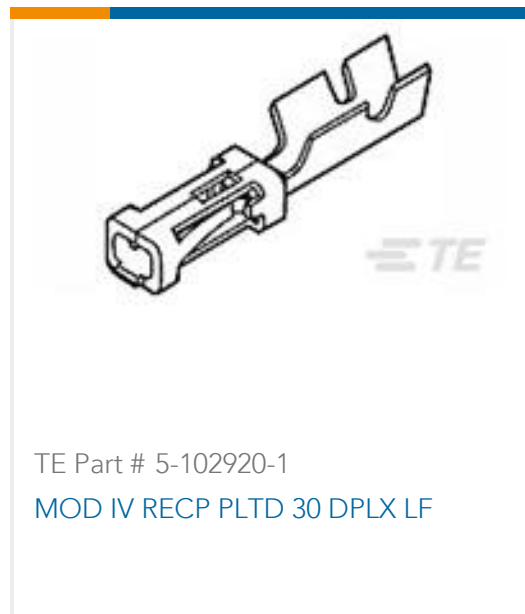
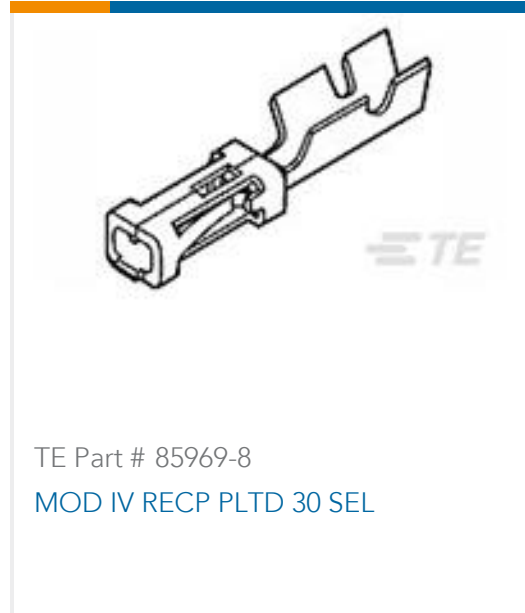

Also in the Series | AMPMODU IV/V

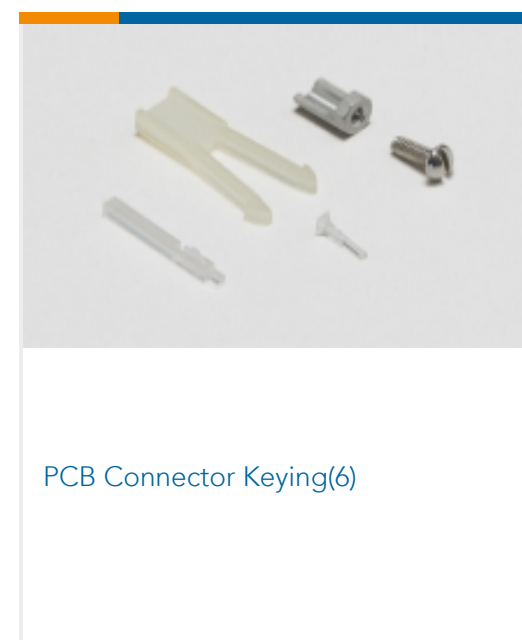
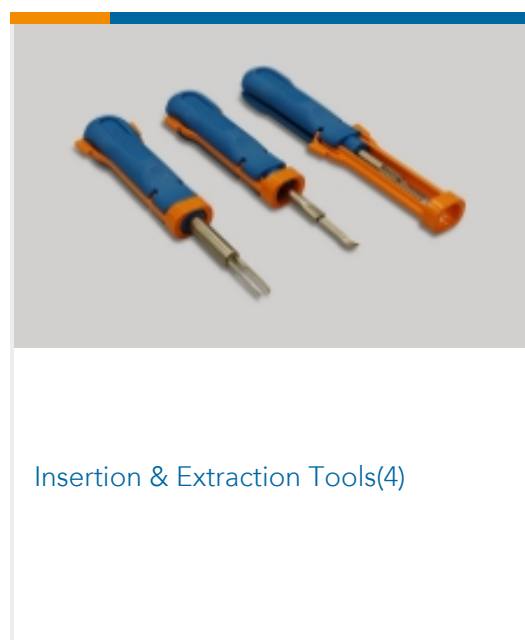
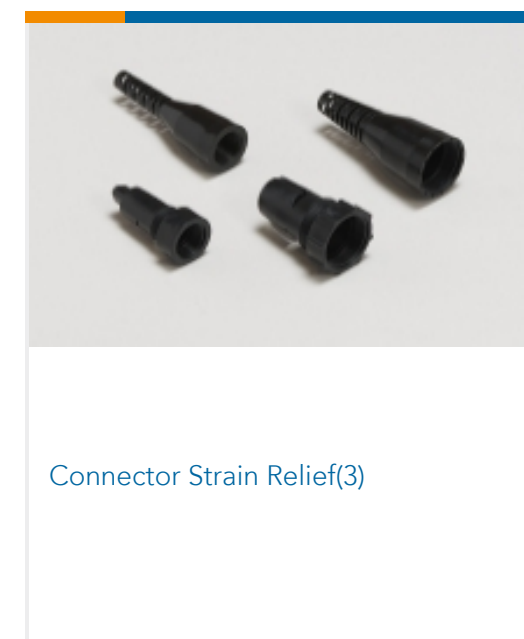
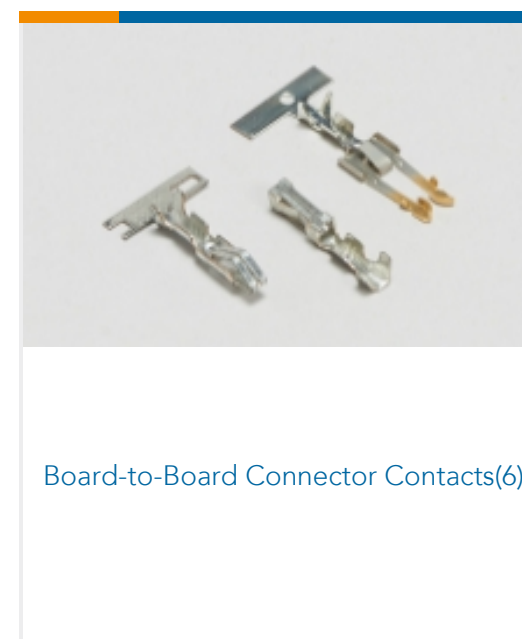
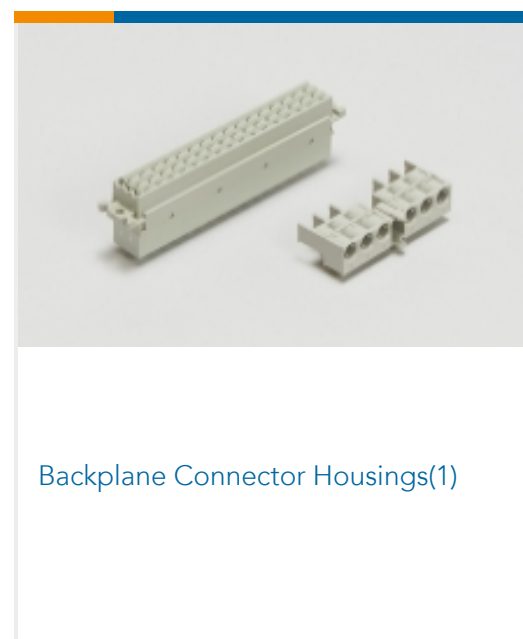
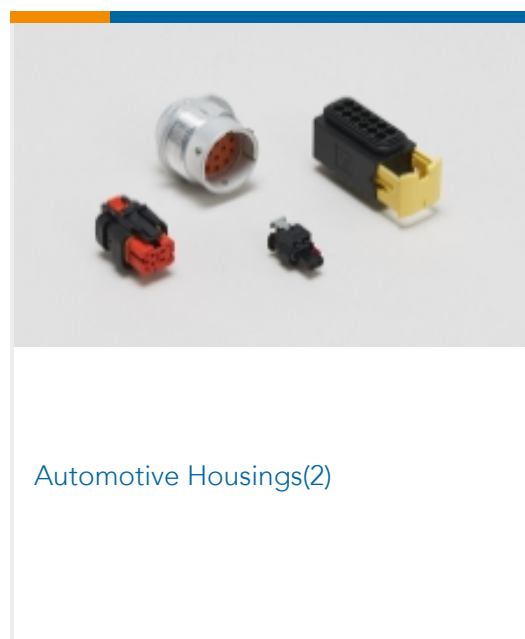



PCB Headers & Receptacles(934)

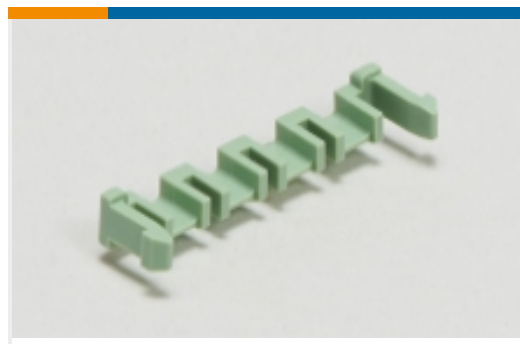

PCB Latches, Locks & Retainers(7)



Rectangular Connector Housings(5)



Standard Rectangular Connectors(8)



Wire-to-Board Connector Assemblies & Housings(447)



Wire-to-Board Connector Contacts (322)

Customers Also Bought

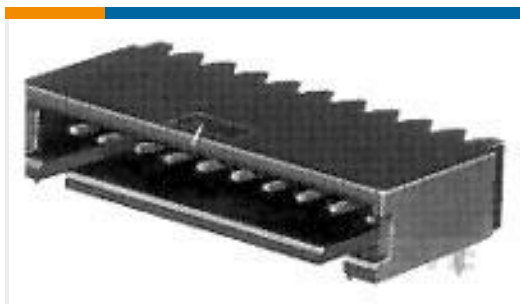

TE Part #5-102523-1
04 MODII HDR SRRA SHRD .100CL



TE Part #1-102241-2
14 MODIV HSG COMP SR .100 POL



TE Part #5-102617-4
12 MODII HDR DRRA SHRD LF



TE Part #3-641208-9
09P MTA156 HDR ASSY FL ST LF



TE Part #4-641208-0
10P MTA156 HDR ASSY FL ST LF



TE Part #3-1445093-0
MICRO MNL HDR ASSY S/ROW AU LF

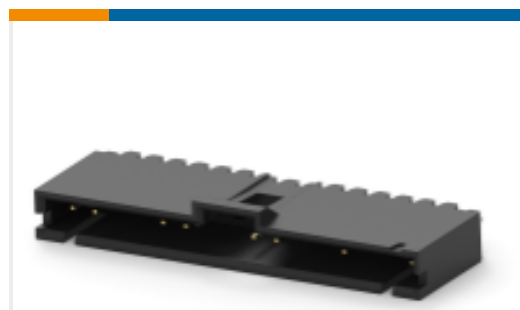

TE Part #5-104912-2
08/16 MTE HDR SRST LTCH .100CL



TE Part #1586821-2
16P MINI UMNL RA HDR ASY OMIT

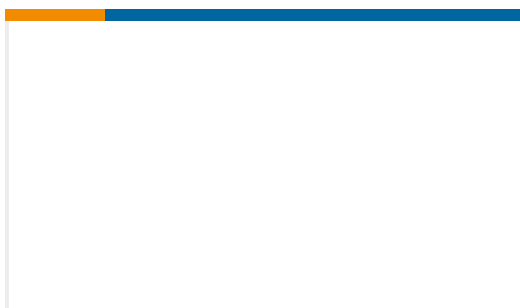

TE Part #839850-E
IDCCS SRC 1,27 12 * SFX SFX 500 PVC

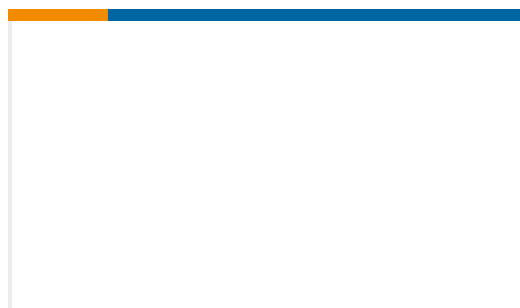

TE Part #839918-E
IDCCS SRC 1,27 8 * SFX SFX 590 PVC

Documents



CAD Files

3D PDF

3D

Customer View Model

[ENG_CVM_CVM_102241-2_AE.2d_dxf.zip](#)

English

Customer View Model

[ENG_CVM_CVM_102241-2_AE.3d_igs.zip](#)

English

Customer View Model

[ENG_CVM_CVM_102241-2_AE.3d_stp.zip](#)

English

By downloading the CAD file I accept and agree to the [Terms and Conditions](#) of use.

Datasheets & Catalog Pages

[AMPMODU_INTERCONNECTION_SYSTEM_SECTION5_CONT](#)

English

Product Specifications

[Product Specification](#)

English

Product Environmental Compliance

[MD_102241-2_041620182337_dmtec](#)

English

[MD_102241-2_041620182337_dmtec](#)

English

Agency Approvals

[UL](#)

English