

100745-3 ✓ ACTIVE

Z-PACK | Z-PACK 2mm HM

TE Internal #: 100745-3

Backplane Connector Housings, Board-to-Board, 6 Position, 1 Row, 6 Column, Plug, Printed Circuit Board, Board Mount, Z-PACK 2mm HM

[View on TE.com >](#)



Connectors > PCB Connectors > Backplane Connectors > Backplane Connector Housings



Connector System: **Board-to-Board**

Number of Positions: **6**

Centerline (Pitch): **7.5 mm [ .295 in ]**

Row-to-Row Spacing: **7.5 mm [ .295 in ]**

Number of Rows: **1**

## Features

### Product Type Features

Connector System	Board-to-Board
Connector & Housing Type	Plug
Sealable	No
Connector & Contact Terminates To	Printed Circuit Board

### Configuration Features

PCB Mount Orientation	Vertical
Number of Positions	6
Number of Rows	1
Number of Columns	6

### Body Features

Primary Product Color	Gray
-----------------------	------

### Mechanical Attachment

Mating Alignment Type	Multi-Purpose Center
Mating Retention	With



Mating Alignment	With
Connector Mounting Type	Board Mount

### Housing Features

Housing Material	Glass Filled Polyester
Centerline (Pitch)	7.5 mm[.295 in]

### Dimensions

Connector Length	49.9 mm[1.966 in]
Connector Height	13.45 mm[.529 in]
Row-to-Row Spacing	7.5 mm[.295 in]

### Usage Conditions

Operating Temperature Range	-55 – 125 °C[-67 – 257 °F]
-----------------------------	----------------------------

### Industry Standards

UL Flammability Rating	UL 94V-0
------------------------	----------

### Packaging Features

Packaging Method	Tube
------------------	------

## Product Compliance

[For compliance documentation, visit the product page on TE.com>](#)









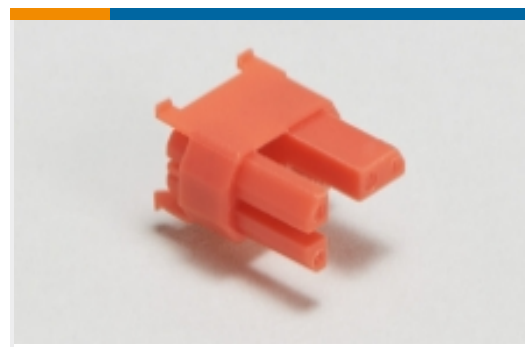
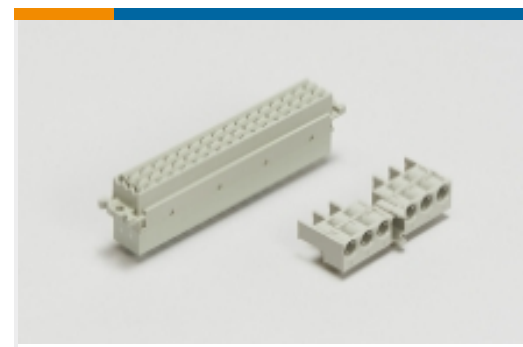

EU RoHS Directive 2011/65/EU	Compliant
EU ELV Directive 2000/53/EC	Compliant
China RoHS 2 Directive MIIT Order No 32, 2016	No Restricted Materials Above Threshold
EU REACH Regulation (EC) No. 1907/2006	Current ECHA Candidate List: JUNE 2023 (235) Candidate List Declared Against: JUNE 2023 (235) Does not contain REACH SVHC
Halogen Content	Not Low Halogen - contains Br or Cl > 900 ppm.
Solder Process Capability	Not applicable for solder process capability

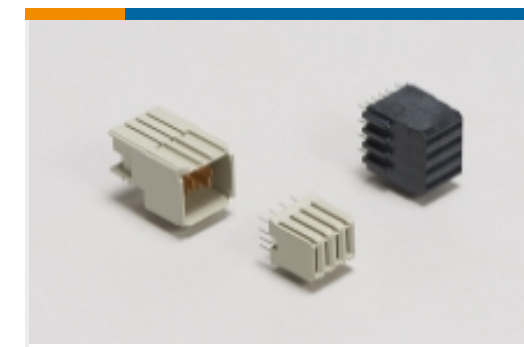
#### Product Compliance Disclaimer

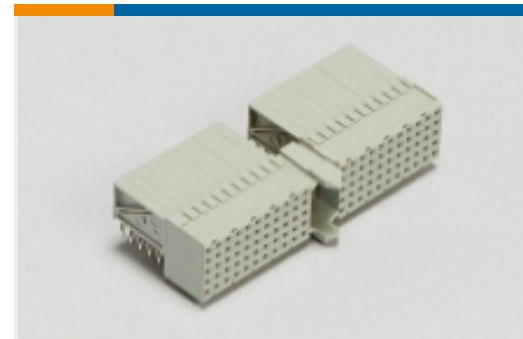
This information is provided based on reasonable inquiry of our suppliers and represents our current actual knowledge based on the information they provided. This information is subject to change. The part numbers that TE has identified as EU RoHS compliant have a maximum concentration of 0.1% by weight in homogenous materials for lead, hexavalent chromium, mercury, PBB, PBDE, DBP, BBP, DEHP, DIBP, and 0.01% for cadmium, or qualify for an exemption to these limits as defined in the Annexes of Directive 2011/65/EU (RoHS2). Finished electrical and electronic equipment products will be CE marked as required by Directive 2011/65/EU. Components may not be CE marked. Additionally, the part

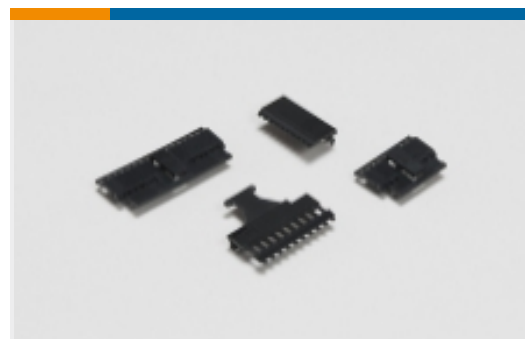
numbers that TE has identified as EU ELV compliant have a maximum concentration of 0.1% by weight in homogenous materials for lead, hexavalent chromium, and mercury, and 0.01% for cadmium, or qualify for an exemption to these limits as defined in the Annexes of Directive 2000/53/EC (ELV). Regarding the REACH Regulation, the information TE provides on SVHC in articles for this part number is based on the latest European Chemicals Agency (ECHA) 'Guidance on requirements for substances in articles' posted at this URL: <https://echa.europa.eu/guidance-documents/guidance-on-reach>

## Also in the Series | Z-PACK 2mm HM

			
Backplane Coding Keys(60)	Backplane Connector Housings(4)	Backplane Guide Hardware(37)	Backplane Power Connectors(6)
			
Board-to-Board Connector Contacts(2)	Hard Metric Backplane Connectors (269)	High Speed Backplane Connectors(1)	Insertion & Extraction Tools(2)
			
PCB Connector Covers(4)	PCB Connector Shrouds(39)	PCB Ferrules & Shields(19)	Rectangular Power Connectors(87)

## Customers Also Bought

			
TE Part #2110759-1 PT CONN ASSY 20 POS 16G SFP	TE Part #5569381-1 STK MJ ASSY,8POS,2X1,SHLD,CAT5	TE Part #2204061-2 CONNECTOR ASSEMBLY, SEC II POW	TE Part #5645518-1 MSS SER 4 SPL ON STRIP

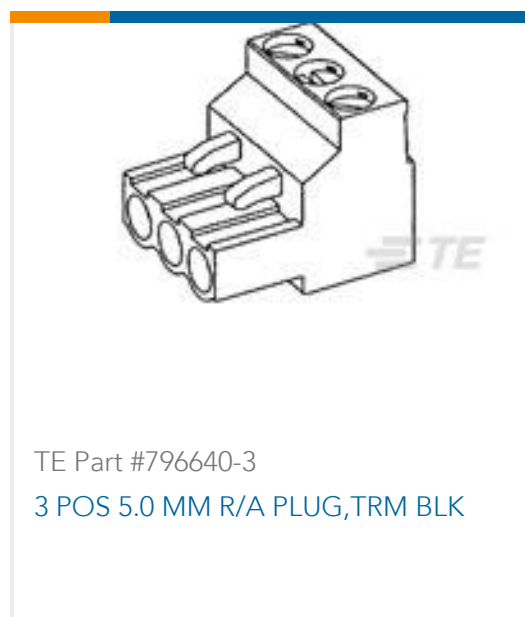

## Documents

### Product Drawings

Z-PACK/L M-HSG 06P.

English

### CAD Files

3D PDF

3D

Customer View Model

[ENG\\_CVM\\_CVM\\_100745-3\\_B.2d\\_dxf.zip](#)

English

Customer View Model

[ENG\\_CVM\\_CVM\\_100745-3\\_B.3d\\_igs.zip](#)

English

Customer View Model

[ENG\\_CVM\\_CVM\\_100745-3\\_B.3d\\_stp.zip](#)

English

By downloading the CAD file I accept and agree to the [Terms and Conditions](#) of use.

### Product Specifications

1.5D/2.5D TYPE C COAX CONNECTOR

English

Product Specification

English

### Product Environmental Compliance

Product Compliance

English

Product Compliance

English

### Agency Approvals

UL Report

English