

100745-1 ✓ ACTIVE

Z-PACK | Z-PACK 2mm HM

TE Internal #: 100745-1

Backplane Connector Housings, Cable-to-Board / Board-to-Board,
6 Position, 6 Column, Housing for Male Terminals, Wire & Cable,
Power, Z-PACK 2mm HM

[View on TE.com >](#)



Connectors > PCB Connectors > Backplane Connectors > Backplane Connector Housings



Connector System: **Board-to-Board, Cable-to-Board**

Number of Positions: **6**

Centerline (Pitch): **7.5 mm [.295 in]**

Number of Columns: **6**

Connector & Housing Type: **Housing for Male Terminals**

Features

Product Type Features

Connector System	Board-to-Board, Cable-to-Board
Connector & Housing Type	Housing for Male Terminals
Connector & Contact Terminates To	Wire & Cable

Configuration Features

PCB Mount Orientation	Vertical
Number of Positions	6
Number of Columns	6

Mechanical Attachment

Mating Alignment Type	Guides
Mating Alignment	With
Connector Mounting Type	Board Mount

Housing Features

Housing Material	Glass Filled Polyester
Centerline (Pitch)	7.5 mm[.295 in]



Usage Conditions

Operating Temperature Range	-55 – 125 °C[-67 – 257 °F]
-----------------------------	----------------------------

Operation/Application

Circuit Application	Power
---------------------	-------

Packaging Features

Packaging Method	Tube
------------------	------

Product Compliance

[For compliance documentation, visit the product page on TE.com>](#)

EU RoHS Directive 2011/65/EU	Compliant
EU ELV Directive 2000/53/EC	Compliant
China RoHS 2 Directive MIIT Order No 32, 2016	No Restricted Materials Above Threshold
EU REACH Regulation (EC) No. 1907/2006	Current ECHA Candidate List: JUNE 2023 (235) Candidate List Declared Against: JUNE 2023 (235) Does not contain REACH SVHC
Halogen Content	Not Low Halogen - contains Br or Cl > 900 ppm.
Solder Process Capability	Not applicable for solder process capability

Product Compliance Disclaimer

This information is provided based on reasonable inquiry of our suppliers and represents our current actual knowledge based on the information they provided. This information is subject to change. The part numbers that TE has identified as EU RoHS compliant have a maximum concentration of 0.1% by weight in homogenous materials for lead, hexavalent chromium, mercury, PBB, PBDE, DBP, BBP, DEHP, DIBP, and 0.01% for cadmium, or qualify for an exemption to these limits as defined in the Annexes of Directive 2011/65/EU (RoHS2). Finished electrical and electronic equipment products will be CE marked as required by Directive 2011/65/EU. Components may not be CE marked. Additionally, the part numbers that TE has identified as EU ELV compliant have a maximum concentration of 0.1% by weight in homogenous materials for lead, hexavalent chromium, and mercury, and 0.01% for cadmium, or qualify for an exemption to these limits as defined in the Annexes of Directive 2000/53/EC (ELV). Regarding the REACH Regulation, the information TE provides on SVHC in articles for this part number is based on the latest European Chemicals Agency (ECHA) 'Guidance on requirements for substances in articles' posted at this URL: <https://echa.europa.eu/guidance-documents/guidance-on-reach>

Also in the Series | [Z-PACK 2mm HM](#)

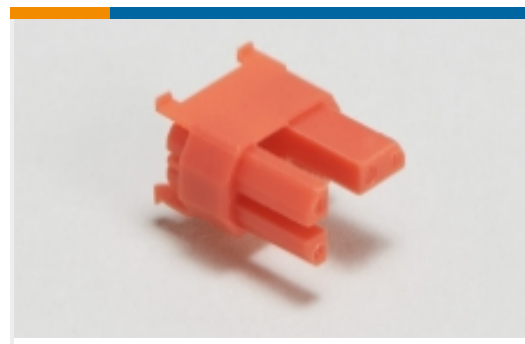

Backplane Coding Keys(60)

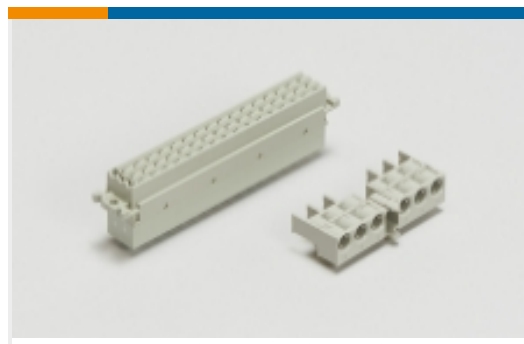

Backplane Connector Housings(4)



Backplane Guide Hardware(37)

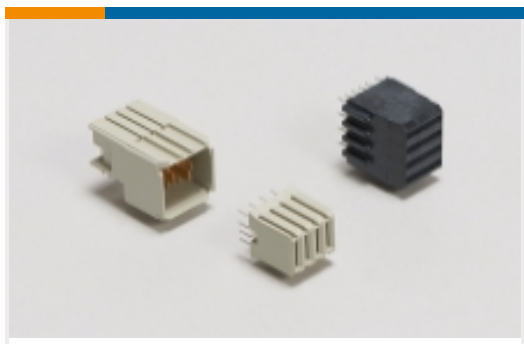

Backplane Power Connectors(6)



Board-to-Board Connector Contacts(2)

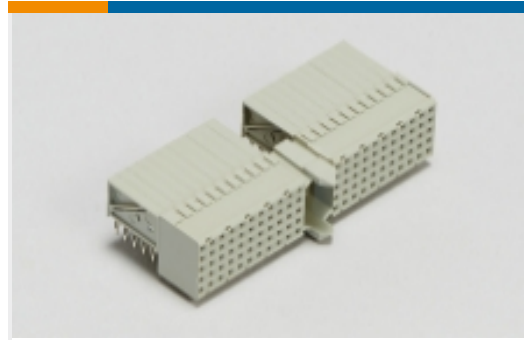

Hard Metric Backplane Connectors (269)

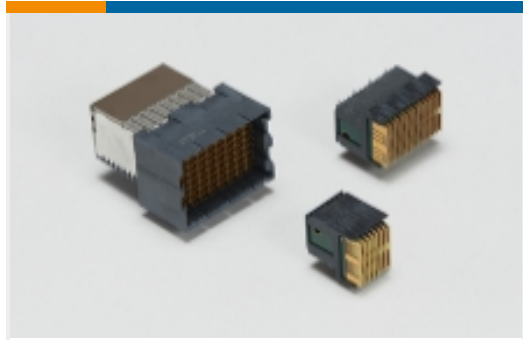

High Speed Backplane Connectors(1)



Insertion & Extraction Tools(2)

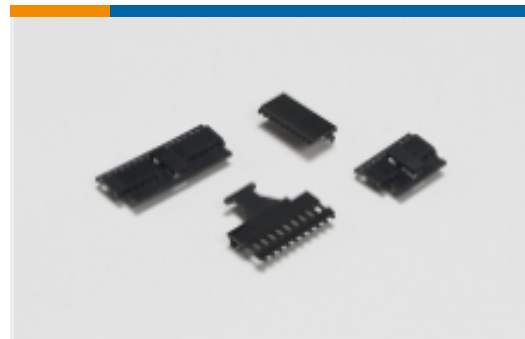

PCB Connector Covers(4)



PCB Connector Shrouds(39)



PCB Ferrules & Shields(19)



Rectangular Power Connectors(87)

Customers Also Bought



TE Part #1658694-4
AMP-LATCH UNV HDR,50 POSN,VERT

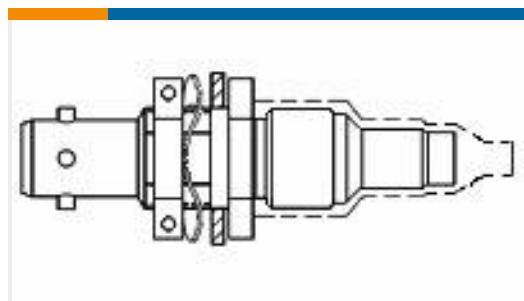

TE Part #143981-000
DK-621-0434-1S



TE Part #5103308-1
A/L LOW PRO HDR 10P VERT BLACK

Documents

[Product Drawings](#)
[Z-PACK/L M-HSG 06P.](#)

English

CAD Files

[3D PDF](#)

[3D](#)

[Customer View Model](#)



[ENG_CVM_CVM_100745-1_B.2d_dxf.zip](#)

English

Customer View Model

[ENG_CVM_CVM_100745-1_B.3d_igs.zip](#)

English

Customer View Model

[ENG_CVM_CVM_100745-1_B.3d_stp.zip](#)

English

By downloading the CAD file I accept and agree to the [Terms and Conditions](#) of use.

Product Specifications

1.5D/2.5D TYPE C COAX CONNECTOR

English

Product Specification

English

Product Environmental Compliance

TE Material Declaration

English