

1-968855-3 ✓ ACTIVE

AMP | AMP MCP Connector System

TE Internal #: 1-968855-3

Automotive Terminals, Receptacle, Mating Tab Width 2.8 mm [.11 in], Tab Thickness .8 mm [.031 in], 20 – 17 AWG Wire Size, AMP MCP Connector System

[View on TE.com >](#)



Terminals & Splices > Automotive Terminals > AMP MCP, RECEPTACLE AND TAB



Terminal Type: **Receptacle**

Mating Tab Width: **2.8 mm [.11 in]**

Mating Tab Thickness: **.8 mm [.031 in]**

Terminal Transmits: **0 – 24 A (Low Power)**

Wire Size: **20 – 17 AWG**

[All AMP MCP, RECEPTACLE AND TAB \(129\)](#)

Features

Product Type Features

Receptacle Style	180°
Sealable	Yes
Primary Locking Feature	Locking Lance

Body Features

Terminal Seal Type	Single Wire Seal (SWS)
--------------------	------------------------

Contact Features

Contact Size	2.8mm
Contact Fabrication	Stamped & Formed
Wire Contact Termination Area Plating Material	Silver
Typical Current Rating	15 A
Crimp Type	F-Crimp
Terminal Type	Receptacle
Mating Tab Width	2.8 mm[.11 in]
Mating Tab Thickness	.8 mm[.031 in]
Interface Plating	Silver (Ag)

Termination Features



Termination Method to Wire & Cable	Crimp
Product Terminates To	Wire

Dimensions

Compatible Insulation Diameter Range	1.3 – 2.1 mm [.051 – .083 in]
Wire Size	.5 – 1 mm ²
Wire Size Search	17 AWG, 18 AWG, 19 AWG, 20 AWG

Usage Conditions

Insulation Option	Uninsulated
Operating Temperature (Max)	80 °C, 85 °C, 90 °C, 100 °C, 105 °C, 110 °C, 120 °C, 125 °C, 130 °C, 140 °C [176 °F][185 °F][194 °F][212 °F][221 °F][230 °F][248 °F][257 °F][266 °F][284 °F]
Operating Temperature Range	-40 – 140 °C [-40 – 284 °F]

Operation/Application

Compatible With Wire Base Material	Copper
------------------------------------	--------

Industry Standards

Agency/Standard	LV214
-----------------	-------

Packaging Features

Packaging Quantity	4000
Packaging Method	Reel

Other

Terminal Transmits	0 – 24 A (Low Power)
--------------------	----------------------

Product Compliance

[For compliance documentation, visit the product page on TE.com>](#)

EU RoHS Directive 2011/65/EU	Compliant
EU ELV Directive 2000/53/EC	Compliant
China RoHS 2 Directive MIIT Order No 32, 2016	No Restricted Materials Above Threshold
EU REACH Regulation (EC) No. 1907/2006	Current ECHA Candidate List: JUNE 2023 (235) Candidate List Declared Against: JUNE 2023 (235) Does not contain REACH SVHC
Halogen Content	Low Halogen - Br, Cl, F, I < 900 ppm per homogenous material. Also BFR/CFR/PVC

Free

Solder Process Capability

Not applicable for solder process capability

Product Compliance Disclaimer

This information is provided based on reasonable inquiry of our suppliers and represents our current actual knowledge based on the information they provided. This information is subject to change. The part numbers that TE has identified as EU RoHS compliant have a maximum concentration of 0.1% by weight in homogenous materials for lead, hexavalent chromium, mercury, PBB, PBDE, DBP, BBP, DEHP, DIBP, and 0.01% for cadmium, or qualify for an exemption to these limits as defined in the Annexes of Directive 2011/65/EU (RoHS2). Finished electrical and electronic equipment products will be CE marked as required by Directive 2011/65/EU. Components may not be CE marked. Additionally, the part numbers that TE has identified as EU ELV compliant have a maximum concentration of 0.1% by weight in homogenous materials for lead, hexavalent chromium, and mercury, and 0.01% for cadmium, or qualify for an exemption to these limits as defined in the Annexes of Directive 2000/53/EC (ELV). Regarding the REACH Regulation, the information TE provides on SVHC in articles for this part number is based on the latest European Chemicals Agency (ECHA) 'Guidance on requirements for substances in articles' posted at this URL: <https://echa.europa.eu/guidance-documents/guidance-on-reach>

Compatible Parts



TE Part # CAT-L489-CH8172
LEAVYSEAL Housings



TE Part # CAT-H3399-CH8172
Heavy Duty Sealed Connector Series Housings



TE Part # CAT-AM705-CH8172
AMP MCP, SEALED CONNECTOR HOUSING



TE Part # 1-1579007-2
EXTRACTION TOOL



TE Part # 1579007-1
AUSDRUECKWERKZEUG



TE Part # 828922-1
2,5MM CAVITY PLUG FOR 5,4MM DI



TE Part # 1976143-1
SDE COMMERCIAL TOOL OR DIE



TE Part # 2305570-1
Strip Terminal Cutter-Side Feed-No Crimp



TE Part # CAT-AM705-CH8173
AMP MCP Unsealed Connector Housings



TE Part # 1376235-2
3POS MQS REC SEALED COD B



TE Part # 2278584-1
67 POS,MIXED,REC HSG,ASSY, SEALED TYPE180



TE Part # 9-1452415-9
58POS CONNECTOR ASSY F. CONNECTOR154POS



TE Part # 828904-1
SINGLE WIRE SEAL FOR J.P.T.CON



TE Part # 1-1823440-1
22POS, MIXED, REC HSG, ASSY, SEALED



TE Part # 1-2177196-1
MCP2.8/MOS BU-GEH5P



TE Part # 1-2293551-1
62POS, MIXED, REC HSG, ASSY, SLD



TE Part # 1-2344950-1
95POS, HYBRID, REC HSG, ASSY, COD A



TE Part # 1976143-2
PRO-CRIMPER DIE



TE Part # 2-2293551-1
62POS, MIXED, REC HSG, ASSY, SLD



TE Part # 2-2344950-1
95POS, HYBRID, REC HSG, ASSY, COD B

Also in the Series | AMP MCP Connector System



Automotive Connector Caps & Covers (25)



Automotive Connector Locks & Position Assurance (7)



Automotive Housings (360)



Automotive Terminals (135)



Connector Seals & Cavity Plugs (7)



Insertion & Extraction Tools (13)



Other Automotive Connector Accessories (2)



PCB Headers & Receptacles (30)

Customers Also Bought



TE Part #828905-1
SINGLE-WIRE-SEAL(5MM HOLE)



TE Part #1418884-3
AMP MCP 1.5K, CONTACT, SWS

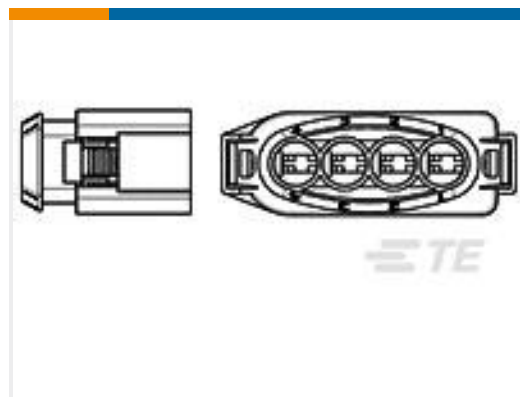

TE Part #1355164-1
SPT FLA-KONT-GEH 4P



TE Part #828904-1
SINGLE WIRE SEAL FOR J.P.T.CON

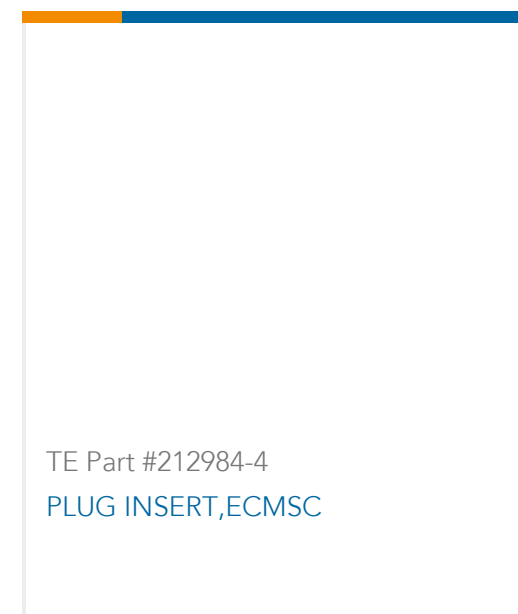
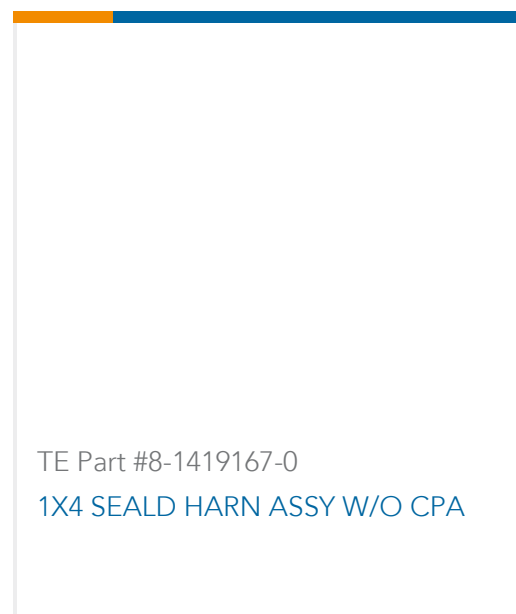

Documents

Product Drawings

AMP MCP 2.8, CONTACT SWS

English

CAD Files

Customer View Model

[ENG_CVM_1-968855-3_J3.3d_igs.zip](#)

English

Customer View Model

[ENG_CVM_1-968855-3_J3.3d_stp.zip](#)

English

Customer View Model

[ENG_CVM_1-968855-3_J3.2d_dxf.zip](#)

English

3D PDF

English

By downloading the CAD file I accept and agree to the [Terms and Conditions](#) of use.

Datasheets & Catalog Pages

HDSCS Catalog

English

CONNECTOR SELECTOR

English

Product Specifications

Application Specification

English

Application Specification

German

Application Specification

English

Product Environmental Compliance

[MD_1-968855-3_05032018314_dmtec](#)

English

[MD_1-968855-3_05032018314_dmtec](#)



English