

1-967627-2 ✓ ACTIVE

AMP | Timer Connector System

TE Internal #: 1-967627-2

Housing for Male Terminals, Wire-to-Wire, 12 Position, .197 in [5 mm] Centerline, Yellow, Signal, Panel Mount, Timer Connector System

[View on TE.com >](#)



Connectors > Automotive Connectors > Automotive Housings > Timer Connector Housing

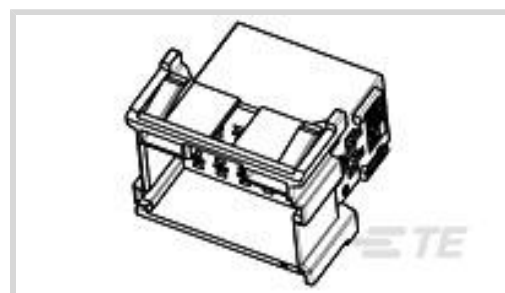

Connector System: **Wire-to-Wire**

Number of Positions: **12**

Connector & Housing Type: **Housing for Male Terminals**

Centerline (Pitch): **5 mm [ .197 in ]**

Sealable: **No**

[All Timer Connector Housing \(585\)](#)

## Features

### Product Type Features

Mixed & Hybrid Connector	No
Connector Shape	Rectangular
Connector System	Wire-to-Wire
Connector & Housing Type	Housing for Male Terminals
Sealable	No
Primary Locking Feature	On the Terminal

### Configuration Features

Number of Positions	12
Number of Rows	3

### Electrical Characteristics

Operating Voltage	28 VDC
Nominal Voltage Architecture	12 V, 24 V

### Body Features

Cable Exit Angle	180°
Primary Product Color	Yellow
Connector & Keying Code	A



### Contact Features

Contact Size	2.8mm
Contact Type	Tab
Mating Tab Width	2.8 mm[.11 in]

### Mechanical Attachment

Terminal Position Assurance	No
Strain Relief	Without
Mating Alignment Type	Keyed
Mating Alignment	With
Connector Mounting Type	Panel Mount

### Housing Features

Housing Material	PA GF
Centerline (Pitch)	5 mm[.197 in]

### Dimensions

Connector Height	30.6 mm[1.205 in]
Product Width	35.45 mm[1.396 in]
Product Length	27.5 mm[1.083 in]

### Usage Conditions

Operating Temperature (Max)	70 °C, 75 °C, 80 °C, 85 °C, 90 °C, 100 °C, 105 °C, 110 °C, 120 °C[158 °F][167 °F][176 °F][185 °F][194 °F][212 °F][221 °F][230 °F][248 °F]
Operating Temperature Range	-40 – 120 °C[-40 – 248 °F]

### Operation/Application

Circuit Application	Signal
---------------------	--------

### Packaging Features

Packaging Method	Bag
------------------	-----

### Other

Serviceable	No
Connector Position Assurance Capable	No

### Product Compliance

For compliance documentation, visit the product page on [TE.com](https://www.te.com)>



EU RoHS Directive 2011/65/EU	Compliant
EU ELV Directive 2000/53/EC	Compliant
China RoHS 2 Directive MIIT Order No 32, 2016	No Restricted Materials Above Threshold
EU REACH Regulation (EC) No. 1907/2006	Current ECHA Candidate List: JUNE 2023 (235) Candidate List Declared Against: JUNE 2023 (235) Does not contain REACH SVHC
Halogen Content	Low Halogen - Br, Cl, F, I < 900 ppm per homogenous material. Also BFR/CFR/PVC Free
Solder Process Capability	Not applicable for solder process capability

Product Compliance Disclaimer

This information is provided based on reasonable inquiry of our suppliers and represents our current actual knowledge based on the information they provided. This information is subject to change. The part numbers that TE has identified as EU RoHS compliant have a maximum concentration of 0.1% by weight in homogenous materials for lead, hexavalent chromium, mercury, PBB, PBDE, DBP, BBP, DEHP, DIBP, and 0.01% for cadmium, or qualify for an exemption to these limits as defined in the Annexes of Directive 2011/65/EU (RoHS2). Finished electrical and electronic equipment products will be CE marked as required by Directive 2011/65/EU. Components may not be CE marked. Additionally, the part numbers that TE has identified as EU ELV compliant have a maximum concentration of 0.1% by weight in homogenous materials for lead, hexavalent chromium, and mercury, and 0.01% for cadmium, or qualify for an exemption to these limits as defined in the Annexes of Directive 2000/53/EC (ELV). Regarding the REACH Regulation, the information TE provides on SVHC in articles for this part number is based on the latest European Chemicals Agency (ECHA) 'Guidance on requirements for substances in articles' posted at this URL: <https://echa.europa.eu/guidance-documents/guidance-on-reach>

## Compatible Parts



TE Part # CAT-T4827-CH8172  
Timer Connector Housing

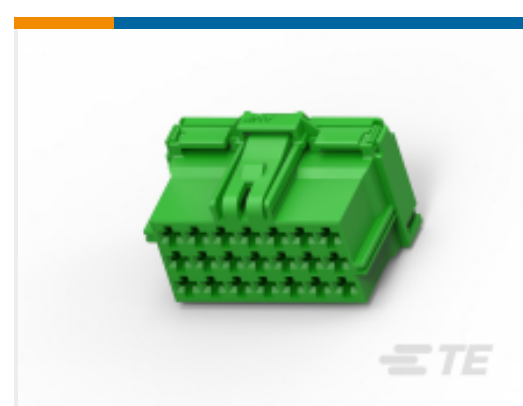

TE Part # CAT-AM705-CH8173  
AMP MCP Unsealed Connector Housings



TE Part # 967632-1  
2. KONT-SICHERUNG 12P



TE Part # CAT-T4827-T273  
TIMER, RECEPTACLE AND TAB

## Also in the Series | [Timer Connector System](#)



Automotive Connector Caps & Covers (12)

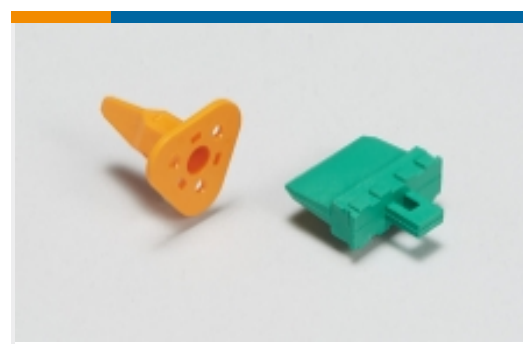

Automotive Connector Locks & Position Assurance(17)



Automotive Housings(233)



Automotive Terminals(145)



Connector Seals & Cavity Plugs(32)

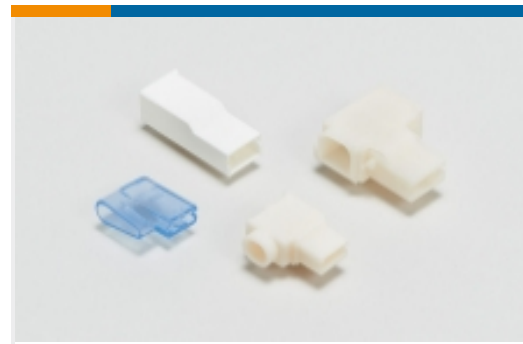

Crimp Terminal Housings(13)



Insertion & Extraction Tools(18)



Other Automotive Connector Accessories(1)

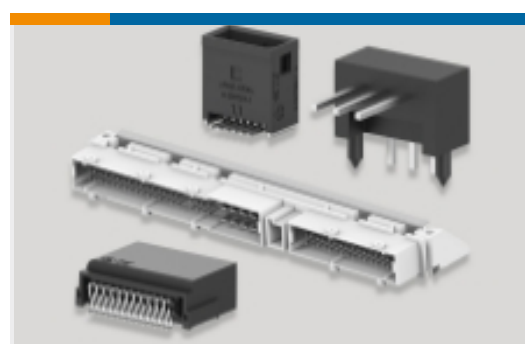

PCB Headers & Receptacles(82)

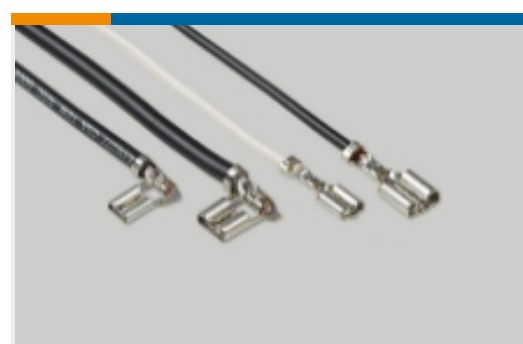

Quick Disconnects(4)

## Customers Also Bought

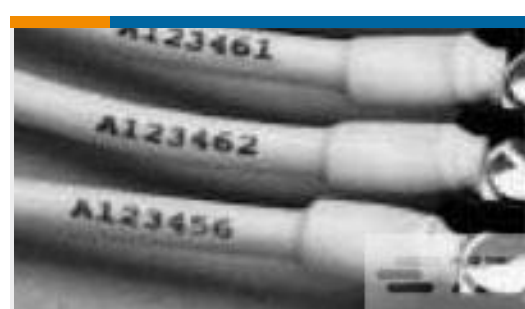

TE Part #5053112041  
RNF-100-1/4-4-STK



TE Part #964587-1  
Timer Connector Housing



TE Part #1-1326032-0  
2.8MM RECP,SEAL,16AWG,REV REEL

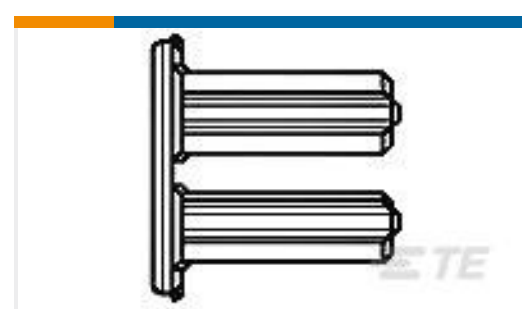

TE Part #968271-1  
2. KONT-SICHERUNG 6P



TE Part #1-511109-0  
V-STRIPPING BLADES R0.5



TE Part #955-179-003  
CGN 7026 LP LC P/FAKRA/3.0

## Documents



### Product Drawings

[FLACHSTE-GEH2,8 12P](#)

English

[FLACHSTE-GEH2,8 12P](#)

English

---

### CAD Files

[3D PDF](#)

3D

Customer View Model

[ENG\\_CVM\\_CVM\\_1-967627-2\\_D.2d\\_dxf.zip](#)

English

Customer View Model

[ENG\\_CVM\\_CVM\\_1-967627-2\\_D.3d\\_igs.zip](#)

English

Customer View Model

[ENG\\_CVM\\_CVM\\_1-967627-2\\_D.3d\\_stp.zip](#)

English

By downloading the CAD file I accept and agree to the [Terms and Conditions](#) of use.

---

### Datasheets & Catalog Pages

[Timer Interconnection System](#)

English

---

### Product Specifications

[Application Specification](#)

English