

1-929974-4 ✓ ACTIVE

AMP | Round Connector System

TE Internal #: 1-929974-4

Automotive Terminals, Socket, Pin Diameter 2.5 mm [.098 in], 20 – 17 AWG Wire Size, .5 – 1 mm² Wire Size, Sealable, Round Connector System

[View on TE.com >](#)



Terminals & Splices > Automotive Terminals > ROUND CONNECTOR SYSTEM, PIN AND SOCKET

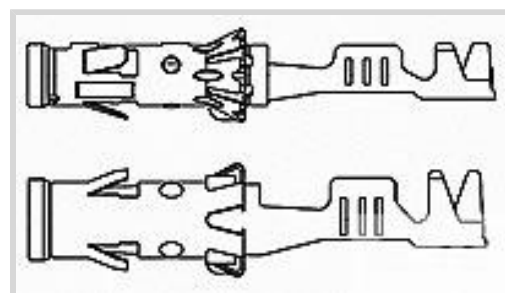

Terminal Type: **Socket**

Mating Pin Diameter: 2.5 mm [.098 in]

Terminal Transmits: 25 – 40 A (Power)

Wire Size: .5 – 1 mm²

All Round Connector System, Pin and Socket (60)

Features

Product Type Features

Receptacle Style	180°
Sealable	Yes
Primary Locking Feature	Locking Lance

Body Features

Terminal Seal Type	Single Wire Seal (SWS)
--------------------	------------------------

Contact Features

Contact Size	2.5mm
Contact Fabrication	Stamped & Formed
Wire Contact Termination Area Plating Material	Tin
Typical Current Rating	40 A
Crimp Type	F-Crimp
Terminal Type	Socket
Mating Pin Diameter	2.5 mm [.098 in]
Interface Plating	Silver (Ag)

Termination Features

Termination Method to Wire & Cable	Crimp
Product Terminates To	Wire



Dimensions

Compatible Insulation Diameter Range	1.2 – 2.1 mm [.047 – .082 in]
Wire Size	.5 – 1 mm ²
Wire Size Search	17 AWG, 18 AWG, 19 AWG, 20 AWG

Usage Conditions

Insulation Option	Uninsulated
Operating Temperature (Max)	80 °C, 85 °C, 90 °C, 100 °C, 105 °C, 110 °C, 120 °C, 125 °C, 130 °C [176 °F][185 °F][194 °F][212 °F][221 °F][230 °F][248 °F][257 °F][266 °F]
Operating Temperature Range	-40 – 130 °C [-40 – 266 °F]

Operation/Application

Compatible With Wire Base Material	Copper
------------------------------------	--------

Packaging Features

Packaging Quantity	3000
Packaging Method	Strip

Other

Terminal Transmits	25 – 40 A (Power)
--------------------	-------------------

Product Compliance

[For compliance documentation, visit the product page on TE.com>](#)

EU RoHS Directive 2011/65/EU	Compliant
EU ELV Directive 2000/53/EC	Compliant
China RoHS 2 Directive MIIT Order No 32, 2016	No Restricted Materials Above Threshold
EU REACH Regulation (EC) No. 1907/2006	Current ECHA Candidate List: JUNE 2023 (235) Candidate List Declared Against: JUNE 2023 (235) Does not contain REACH SVHC
Halogen Content	Low Halogen - Br, Cl, F, I < 900 ppm per homogenous material. Also BFR/CFR/PVC Free
Solder Process Capability	Not applicable for solder process capability

Product Compliance Disclaimer

This information is provided based on reasonable inquiry of our suppliers and represents our current actual knowledge based on the information they provided. This information is subject to change. The part numbers that TE has identified as

EU RoHS compliant have a maximum concentration of 0.1% by weight in homogenous materials for lead, hexavalent chromium, mercury, PBB, PBDE, DBP, BBP, DEHP, DIBP, and 0.01% for cadmium, or qualify for an exemption to these limits as defined in the Annexes of Directive 2011/65/EU (RoHS2). Finished electrical and electronic equipment products will be CE marked as required by Directive 2011/65/EU. Components may not be CE marked. Additionally, the part numbers that TE has identified as EU ELV compliant have a maximum concentration of 0.1% by weight in homogenous materials for lead, hexavalent chromium, and mercury, and 0.01% for cadmium, or qualify for an exemption to these limits as defined in the Annexes of Directive 2000/53/EC (ELV). Regarding the REACH Regulation, the information TE provides on SVHC in articles for this part number is based on the latest European Chemicals Agency (ECHA) 'Guidance on requirements for substances in articles' posted at this URL: <https://echa.europa.eu/guidance-documents/guidance-on-reach>

Compatible Parts

 <p>TE Part # CAT-C4962-CH8172 Circular DIN Housings</p>	 <p>TE Part # 58606-1 PROCRIMP 1.5 & 2.5MM PIN/SEAL</p>	 <p>TE Part # 1-1579007-8 EXTRACTION TOOL</p>	 <p>TE Part # 828920-1 EINZELADERDICHTUNG</p>
 <p>TE Part # 2305570-1 Strip Terminal Cutter-Side Feed-No Crimp</p>	 <p>TE Part # 1394081-1 1,5/2,5MM BU-GEH31P</p>	 <p>TE Part # 4-967325-1 2,5MM BU-GEH 4P,BL</p>	 <p>TE Part # 2151139-1 OCEAN-2.0-APPLICATOR-S-080F160OV</p>
 <p>TE Part # 2151139-2 OCEAN-2.0-APPLICATOR-S-080F160OV</p>	 <p>TE Part # 2387332-1 SDE F 2.5mm CONTACT 0.35-1.0mm2 ASSY</p>	 <p>TE Part # 2387332-2 SDE F 2.5mm CONTACT 0.35-1.0mm2 DIE SET</p>	 <p>TE Part # 5-2151139-1 OCEAN-2.0-APPLICATOR-S-080F160OV</p>
 <p>TE Part # 5-2151139-2 OCEAN-2.0-APPLICATOR-S-080F160OV</p>	 <p>TE Part # 58606-2 PC DIE 1.5 & 2.5 PIN W/S</p>	 <p>TE Part # 7-2151139-1 OCEAN-2.0-APPLICATOR-S-080F160OV</p>	 <p>TE Part # 7-2151139-2 OCEAN-2.0-APPLICATOR-S-080F160OV</p>



KIT

REPRESENTATION ONLY

TE Part # 7-2151139-7
OCEAN_2.0_SPARE_PART_KIT-080F160OV



KIT

REPRESENTATION ONLY

TE Part # 7-2266055-7
OC-080F160O-CRIMPTOOLINGKIT



TE Part # 2-2151139-1
OCEAN-2.0-APPLICATOR-S-080F160OV



TE Part # 2-2151139-2
OCEAN-2.0-APPLICATOR-S-080F160OV

Also in the Series | Round Connector System



Automotive Connector Caps & Covers (4)



Automotive Housings(17)

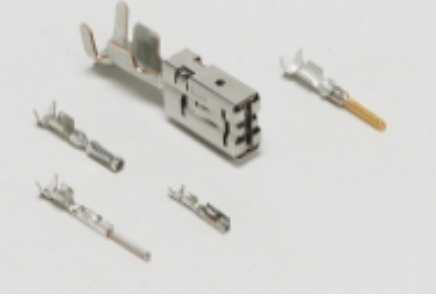

Automotive Terminals(60)



Connector Seals & Cavity Plugs(3)



Insertion & Extraction Tools(8)

Customers Also Bought



TE Part #965576-1
ABDECKKAPPE 90GRD

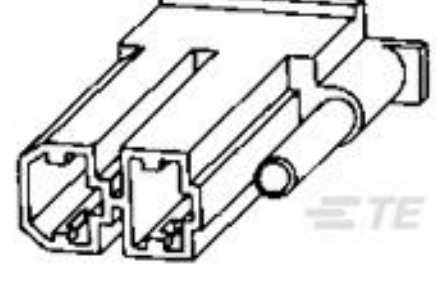

TE Part #171447-3
FF 375 PLUG HSG 2P NYLON BROWN



TE Part #964408-1
Timer Connector Housing



TE Part #1534181-1
AMP MCP Unsealed Connector Housings



TE Part #2141900-2
MT2 A REC 1.6 Contact SRC Sn



TE Part #3157736003
RBK-VWS-125-NR4-X-50MM



TE Part #1393454-1
V23542C1028Z100=28P ABDECKKAPP



Documents

Product Drawings

[2,5MM SWS REC.CONT.](#)

English

CAD Files

Customer View Model

[ENG_CVM_1-929974-4_A5.3d_igs.zip](#)

English

Customer View Model

[ENG_CVM_1-929974-4_A5.3d_stp.zip](#)

English

Customer View Model

[ENG_CVM_1-929974-4_A5.2d_dxf.zip](#)

English

[3D PDF](#)

English

By downloading the CAD file I accept and agree to the [Terms and Conditions](#) of use.

Datasheets & Catalog Pages

[CONNECTOR SELECTOR](#)

English

Product Specifications

[Application Specification](#)

English

[Application Specification](#)

English