



Terminals & Splices > Terminal Housings, Insulation Sleeves & Blocks > Crimp Terminal Housings



Terminal Type: **Receptacle**

Connector & Housing Type: **Receptacle**

Number of Positions: **1**

Terminal Orientation: **Straight**

UL Flammability Rating: **UL 94HB**

### Features

#### Product Type Features

Sealable	No
----------	----

Connector & Housing Type	Receptacle
--------------------------	------------

#### Configuration Features

Number of Positions	1
---------------------	---

#### Body Features

Primary Product Color	Black
-----------------------	-------

#### Contact Features

Terminal Type	Receptacle
---------------	------------

Terminal Orientation	Straight
----------------------	----------

Contact Mating Retention	Without
--------------------------	---------

#### Mechanical Attachment

Mating Alignment	With
------------------	------

Connector Mounting Type	Cable Mount (Free-Hanging)
-------------------------	----------------------------



### Housing Features

Housing Material	Polyamide 4.6 GF
------------------	------------------

### Dimensions

Product Length	24.4 mm[.961 in]
----------------	------------------

### Usage Conditions

Operating Temperature Range	-40 – 105 °C[-40 – 221 °F]
-----------------------------	----------------------------

### Industry Standards

UL Flammability Rating	UL 94HB
------------------------	---------

### Packaging Features

Packaging Quantity	2000
--------------------	------

## Product Compliance

[For compliance documentation, visit the product page on TE.com>](#)

EU RoHS Directive 2011/65/EU	Compliant
EU ELV Directive 2000/53/EC	Compliant
China RoHS 2 Directive MIIT Order No 32, 2016	No Restricted Materials Above Threshold
EU REACH Regulation (EC) No. 1907/2006	Current ECHA Candidate List: JUNE 2023 (235) Candidate List Declared Against: JUNE 2023 (235) Does not contain REACH SVHC
Halogen Content	Low Halogen - Br, Cl, F, I < 900 ppm per homogenous material. Also BFR/CFR/PVC Free
Solder Process Capability	Not applicable for solder process capability

#### Product Compliance Disclaimer

This information is provided based on reasonable inquiry of our suppliers and represents our current actual knowledge based on the information they provided. This information is subject to change. The part numbers that TE has identified as EU RoHS compliant have a maximum concentration of 0.1% by weight in homogenous materials for lead, hexavalent chromium, mercury, PBB, PBDE, DBP, BBP, DEHP, DIBP, and 0.01% for cadmium, or qualify for an exemption to these limits as defined in the Annexes of Directive 2011/65/EU (RoHS2). Finished electrical and electronic equipment products will be CE marked as required by Directive 2011/65/EU. Components may not be CE marked. Additionally, the part numbers that TE has identified as EU ELV compliant have a maximum concentration of 0.1% by weight in homogenous materials for lead, hexavalent chromium, and mercury, and 0.01% for cadmium, or qualify for an exemption to these limits as defined in the Annexes of Directive 2000/53/EC (ELV). Regarding the REACH Regulation, the information TE provides on SVHC in articles for this part number is based on the latest European Chemicals Agency (ECHA) 'Guidance on requirements for substances in articles' posted at this URL: <https://echa.europa.eu/guidance-documents/guidance-on-reach>



## Compatible Parts



## Also in the Series | FASTON 250

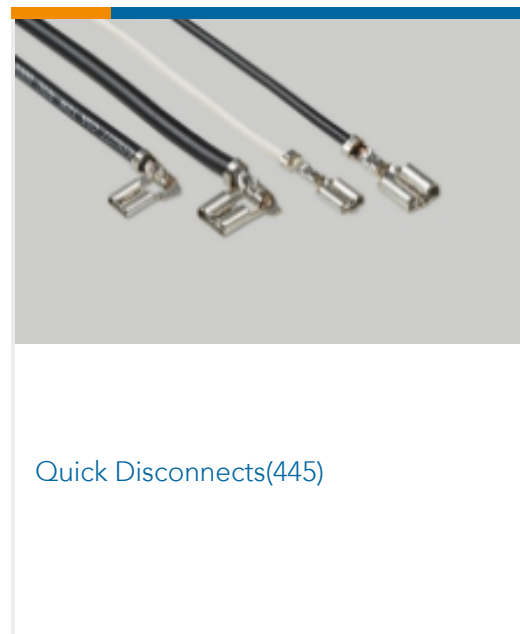
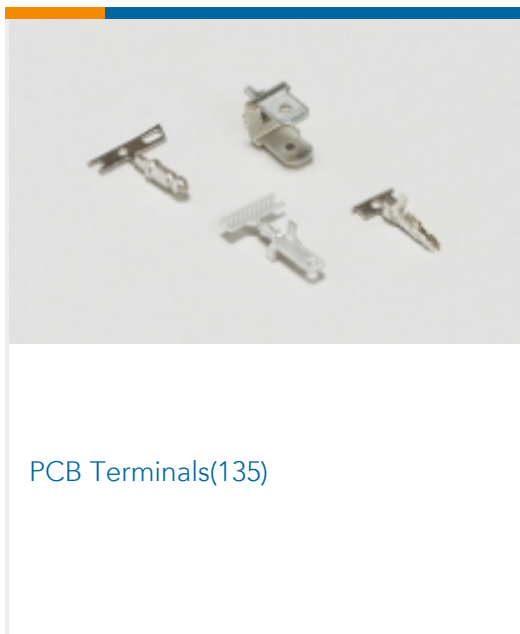
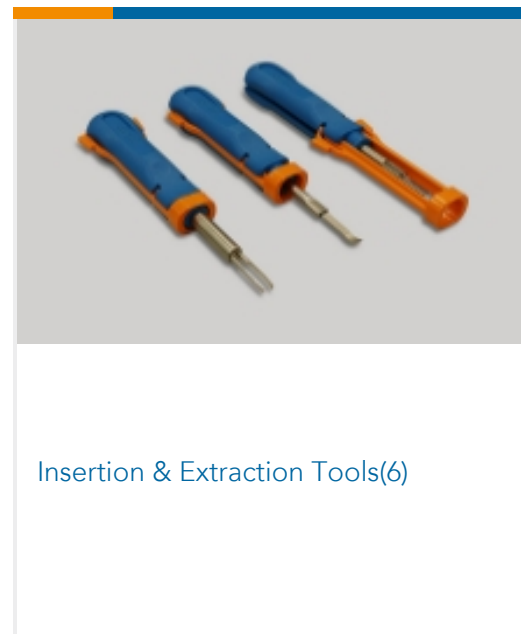
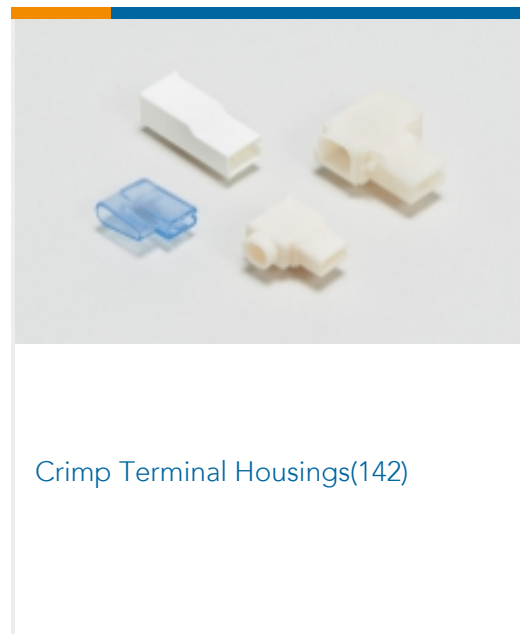
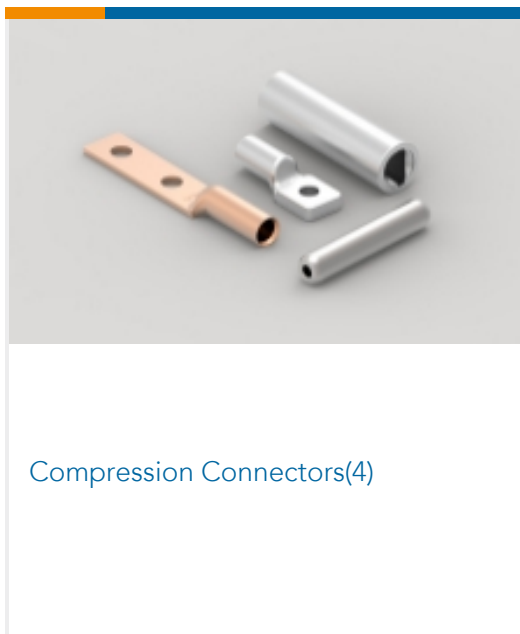

## Customers Also Bought





TE Part #1-1564297-6  
31POS, MIXED, REC HSG, ASSY

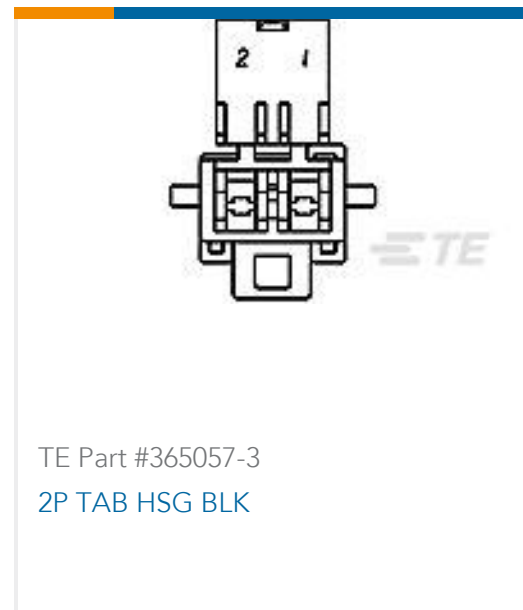

TE Part #365057-3  
2P TAB HSG BLK



TE Part #3-336369-5  
250 FASTON HSG., REC., 1 POS, BLACK

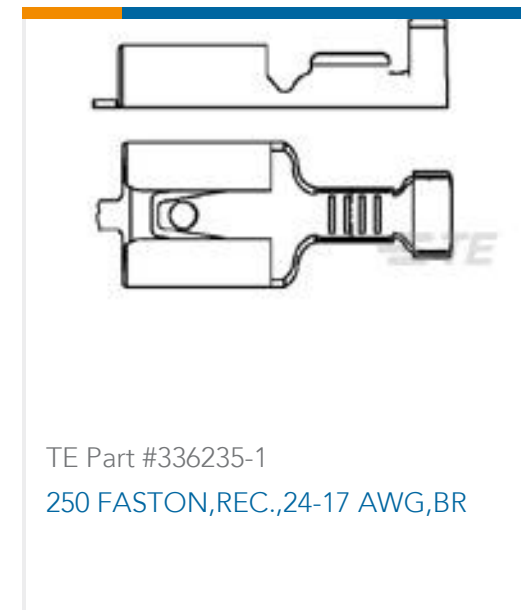

TE Part #336235-1  
250 FASTON, REC., 24-17 AWG, BR



TE Part #ASA876N0085050A000  
617 PLUG, SPEEDTEC



TE Part #HSA202N00480100000  
723 HTEC PLUG, SPEEDTEC

## Documents

### Product Drawings

[250 FASTON HSG., REC., 1 POS, BLACK](#)

English

### CAD Files

[3D PDF](#)

3D

Customer View Model

[ENG\\_CVM\\_CVM\\_1-926539-7\\_K\\_c-1-926539-7-k.2d\\_dxf.zip](#)

English

Customer View Model

[ENG\\_CVM\\_CVM\\_1-926539-7\\_K\\_c-1-926539-7-k.3d\\_igs.zip](#)

English

Customer View Model

[ENG\\_CVM\\_CVM\\_1-926539-7\\_K\\_c-1-926539-7-k.3d\\_stp.zip](#)

English

By downloading the CAD file I accept and agree to the [Terms and Conditions](#) of use.

### Product Specifications

[Engineering Report](#)

English

### Product Environmental Compliance

[Product Compliance](#)

English

[Product Compliance](#)

English

1-926539-7

Crimp Terminal Housings, Receptacle, Receptacle, 1 Position, Straight, UL 94HB,  
Black, Polyamide 4.6 GF, Mating Alignment, FASTON 250

