

1-796404-1 ✓ ACTIVE

AMP | AMP CPC

TE Internal #: 1-796404-1

Circular Power Connectors, Connector Assembly, 250 VDC, Wire-to-Board / Wire-to-Panel, 16 Position, Receptacle, Pin, Signal, Black, AMP CPC

[View on TE.com >](#)



Connectors > Power Connectors > Circular Power > Circular Power Connectors > Connectors with Posted Pin Contacts, CPC Series 1

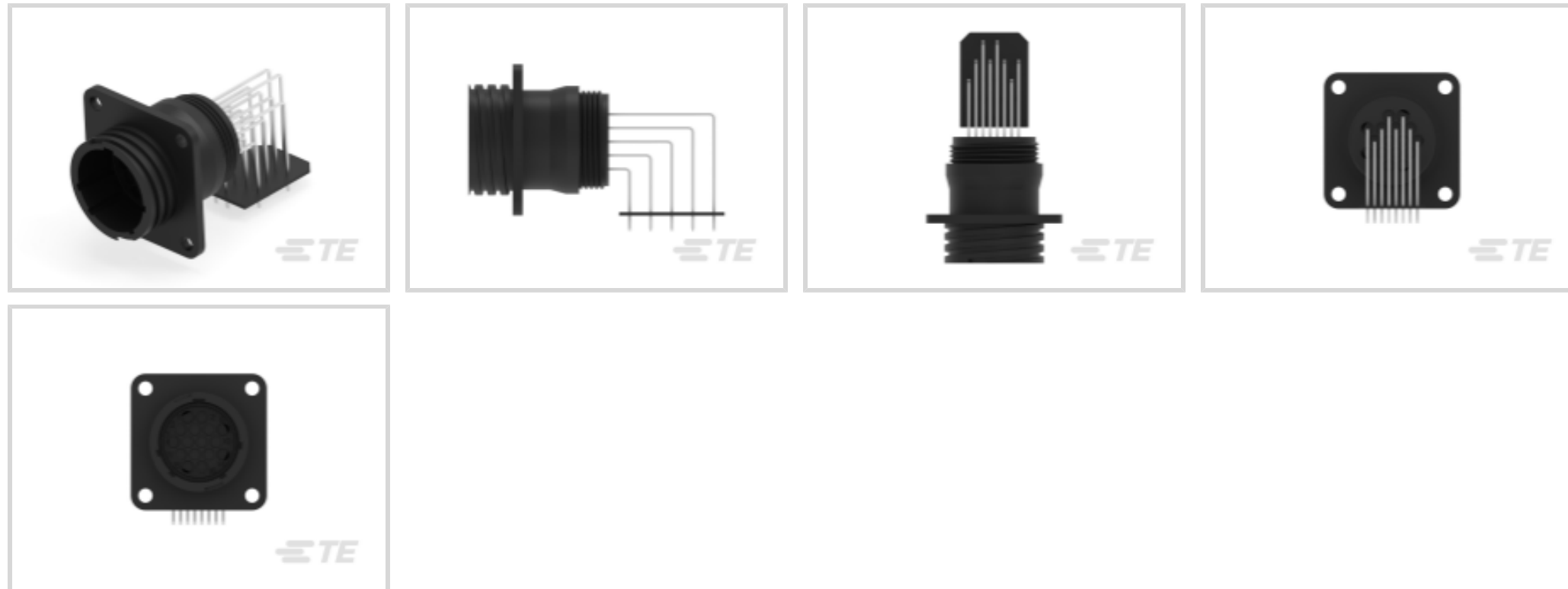

Connector Product Type: **Connector Assembly**

Operating Voltage: **250 VDC**

Connector System: **Wire-to-Board, Wire-to-Panel**

Number of Positions: **16**

Sealable: **No**

[All Connectors with Posted Pin Contacts, CPC Series 1 \(39\)](#)

## Features

### Product Type Features

Connector Product Type	Connector Assembly
Connector System	Wire-to-Board, Wire-to-Panel
Sealable	No
Connector & Housing Type	Receptacle
Circular Connector Shell Type	All Plastic

### Configuration Features

Number of Positions	16
Number of Power Positions	0
Number of Signal Positions	16

### Electrical Characteristics

Operating Voltage	250 VAC
-------------------	---------

### Contact Features



Reverse Gender	No
----------------	----

Contact Type	Pin
--------------	-----

### Termination Features

Termination Method to Printed Circuit Board	Through Hole - Solder
---	-----------------------

### Mechanical Attachment

Mating Alignment Type	Keyed
-----------------------	-------

Mating Alignment	With
------------------	------

Panel Mount Feature Type	Flange with Mounting Holes
--------------------------	----------------------------

Mating Retention Type	Threaded Coupling
-----------------------	-------------------

Polarization Code	A
-------------------	---

Connector Mounting Type	Panel Mount
-------------------------	-------------

Mating Retention	With
------------------	------

Panel Mount Feature	With
---------------------	------

### Housing Features

Housing Color	Black
---------------	-------

Housing Material	PA 6.6
------------------	--------

Circular Connector Shell Size	17
-------------------------------	----

### Dimensions

Assembly Length	61.72 mm[2.43 in]
-----------------	-------------------

### Usage Conditions

Operating Temperature Range	-55 – 105 °C[-67 – 221 °F]
-----------------------------	----------------------------

Fluid Resistance	None
------------------	------

### Operation/Application

Circuit Application	Signal
---------------------	--------

Shielded	No
----------	----

### Industry Standards

UL Flammability Rating	UL 94V-0
------------------------	----------

### Packaging Features

Packaging Quantity	14
--------------------	----

Packaging Method	Tray
------------------	------

### Product Compliance



[For compliance documentation, visit the product page on TE.com>](#)

EU RoHS Directive 2011/65/EU	Compliant
EU ELV Directive 2000/53/EC	Compliant
China RoHS 2 Directive MIIT Order No 32, 2016	No Restricted Materials Above Threshold
EU REACH Regulation (EC) No. 1907/2006	Current ECHA Candidate List: JUNE 2023 (235) Candidate List Declared Against: JUNE 2023 (235) Does not contain REACH SVHC
Halogen Content	BFR/CFR/PVC Free, but Br/Cl >900 ppm in other sources.
Solder Process Capability	Wave solder capable to 265°C

Product Compliance Disclaimer

This information is provided based on reasonable inquiry of our suppliers and represents our current actual knowledge based on the information they provided. This information is subject to change. The part numbers that TE has identified as EU RoHS compliant have a maximum concentration of 0.1% by weight in homogenous materials for lead, hexavalent chromium, mercury, PBB, PBDE, DBP, BBP, DEHP, DIBP, and 0.01% for cadmium, or qualify for an exemption to these limits as defined in the Annexes of Directive 2011/65/EU (RoHS2). Finished electrical and electronic equipment products will be CE marked as required by Directive 2011/65/EU. Components may not be CE marked. Additionally, the part numbers that TE has identified as EU ELV compliant have a maximum concentration of 0.1% by weight in homogenous materials for lead, hexavalent chromium, and mercury, and 0.01% for cadmium, or qualify for an exemption to these limits as defined in the Annexes of Directive 2000/53/EC (ELV). Regarding the REACH Regulation, the information TE provides on SVHC in articles for this part number is based on the latest European Chemicals Agency (ECHA) 'Guidance on requirements for substances in articles' posted at this URL: <https://echa.europa.eu/guidance-documents/guidance-on-reach>

## Compatible Parts

 <p>TE Part # 207299-3 FLANGE PLUG MOUNT CPC</p>	 <p>TE Part # 206037-2 CPC PLUG ASSEMBLY SIZE 17-3</p>	 <p>TE Part # CAT-AM71-C83998B CPC Cable Clamps</p>	 <p>TE Part # 206037-1 CPC PLUG ASSEMBLY SIZE 17-16</p>
 <p>TE Part # 207241-1 CABLE BOOT, SZ 17, CPC</p>	 <p>TE Part # 207387-1 CABLE GRIP, SZ 17, CPC</p>	 <p>TE Part # 207387-2 CABLE GRIP, SZ 17, CPC</p>	 <p>TE Part # 206037-3 CPC PLUG ASSEMBLY SZ 17-16</p>

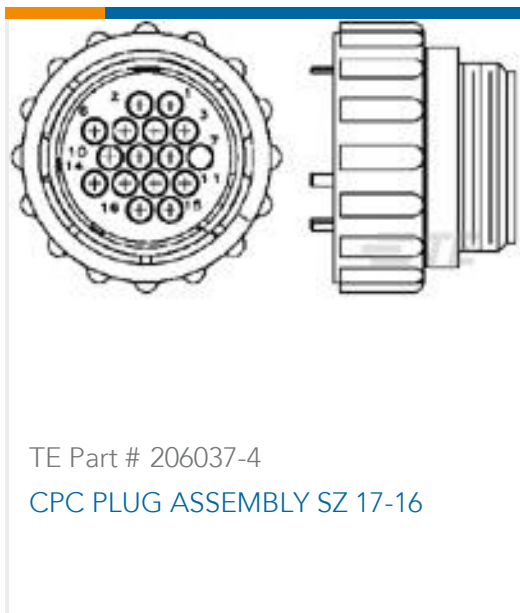

Also in the Series | AMP CPC

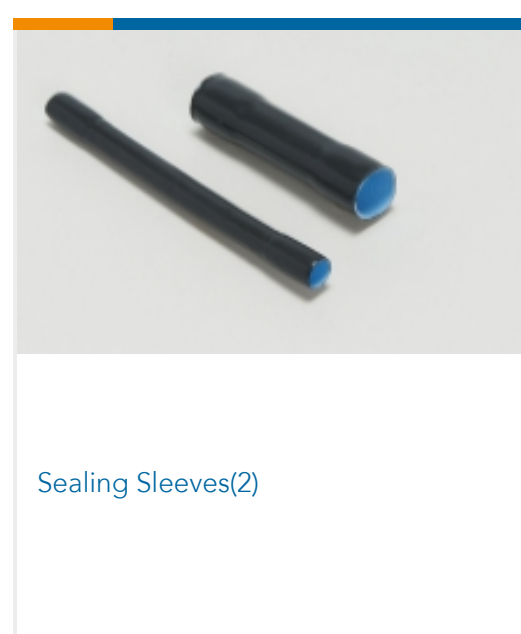
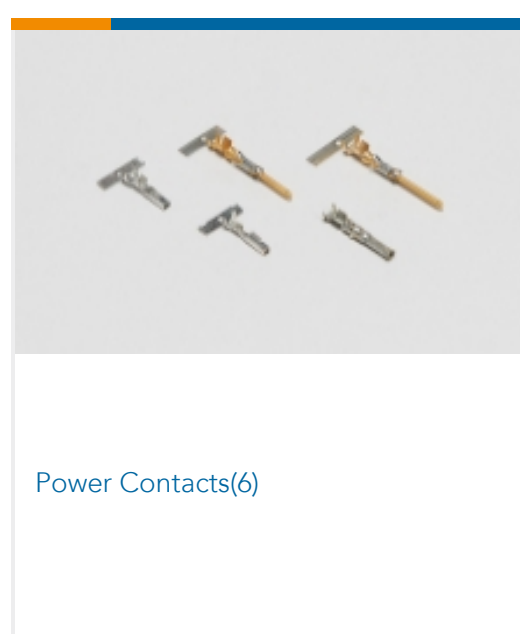
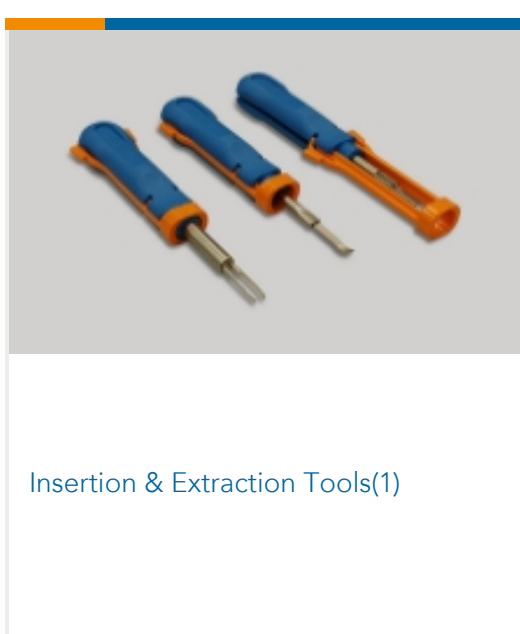
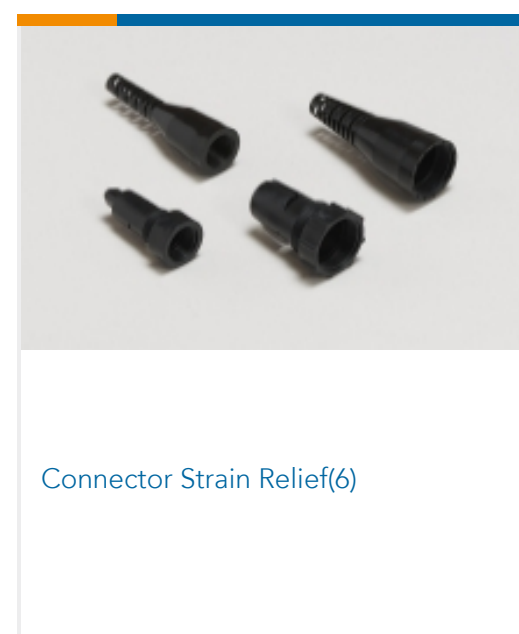
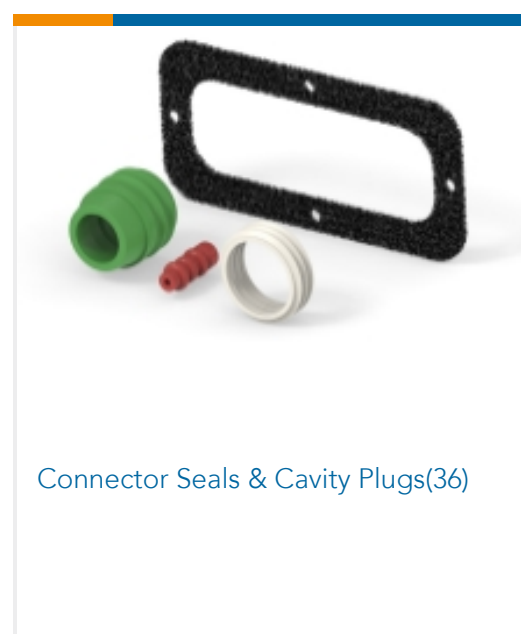
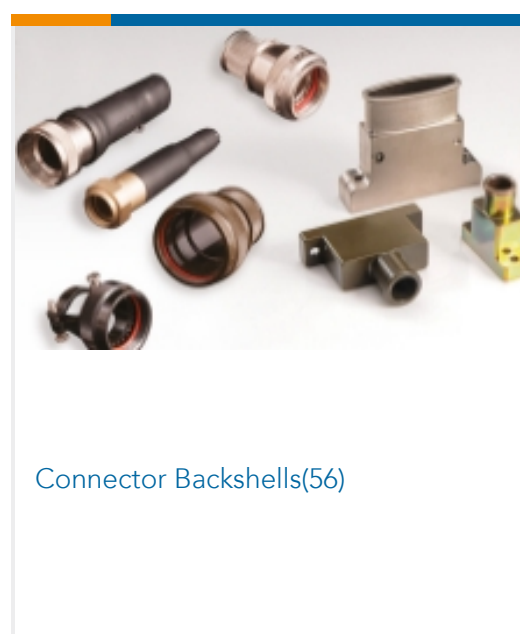
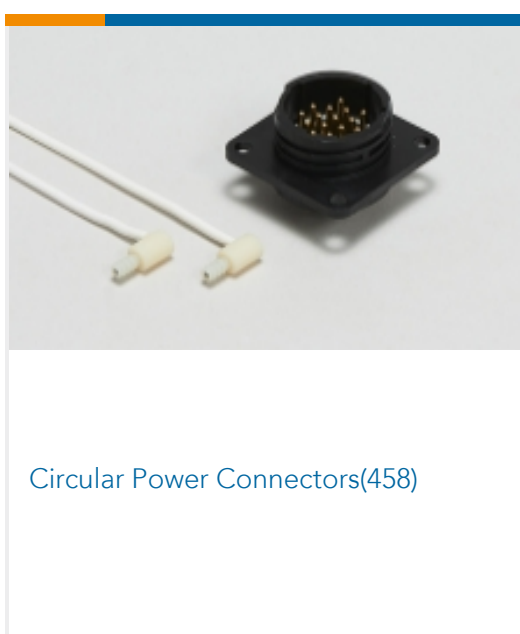
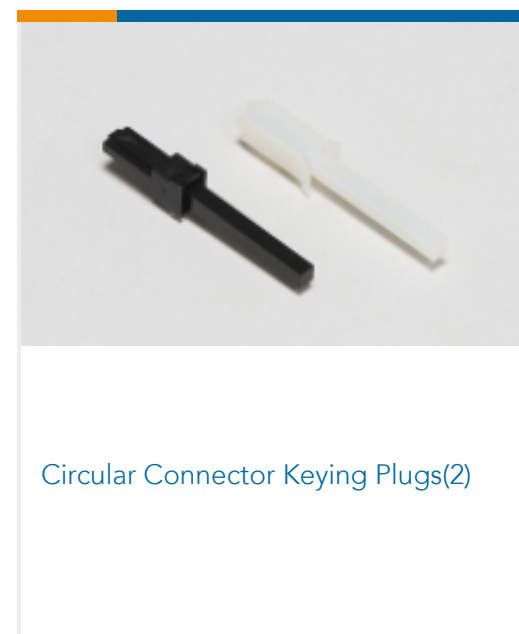
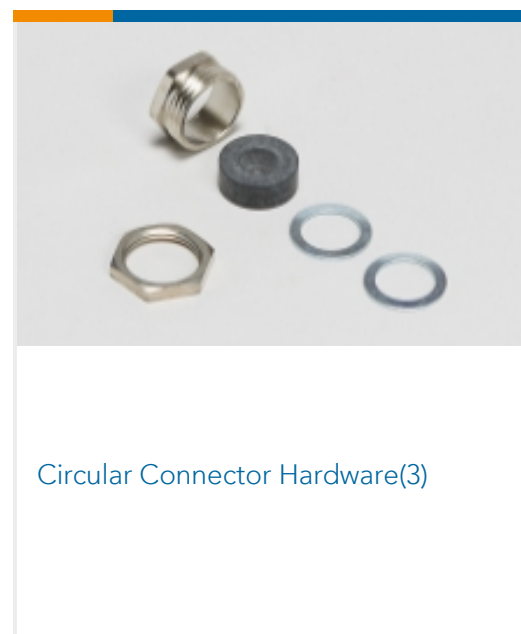
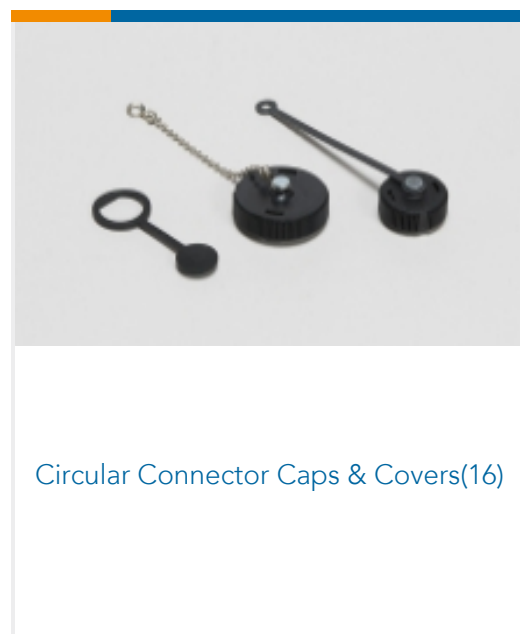
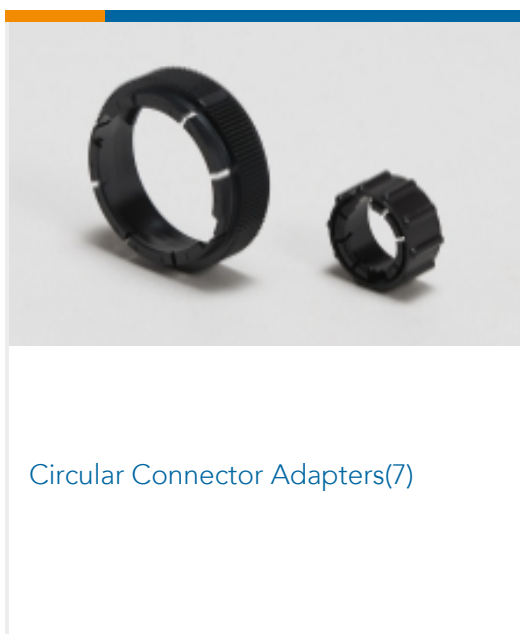

Customers Also Bought





## Documents

### CAD Files

3D PDF

English

Customer View Model

[ENG\\_CVM\\_1-796404-1\\_B.2d\\_dxf.zip](#)

English

Customer View Model

[ENG\\_CVM\\_1-796404-1\\_B.3d\\_igs.zip](#)

English

Customer View Model

[ENG\\_CVM\\_1-796404-1\\_B.3d\\_stp.zip](#)

English

3D PDF

3D

Customer View Model

[ENG\\_CVM\\_CVM\\_1-796404-1\\_D.2d\\_dxf.zip](#)

English

Customer View Model



[ENG\\_CVM\\_CVM\\_1-796404-1\\_D.3d\\_igs.zip](#)

English

**Customer View Model**

[ENG\\_CVM\\_CVM\\_1-796404-1\\_D.3d\\_stp.zip](#)

English

By downloading the CAD file I accept and agree to the [Terms and Conditions](#) of use.

---

### Datasheets & Catalog Pages

[AMP Circular Connectors for Commercial Signal & Power Applications](#)

English

---

### Product Specifications

[Application Specification](#)

English