

1-794772-0 ✓ ACTIVE

MATE-N-LOK | Mini-Universal MATE-N-LOK

TE Internal #: 1-794772-0

Interface Seal, Urethane Foam, -40 – 90 °C [-40 – 194 °F] Operating Temperature, Mini-Universal MATE-N-LOK

[View on TE.com >](#)



Connectors > Connector Accessories > Connector Seals & Cavity Plugs



Connector Seal & Plug Type: **Interface Seal**

Primary Product Material: **Urethane Foam**

Operating Temperature (Max): **90 °C [194 °F]**

Operating Temperature Range: **-40 – 90 °C [-40 – 194 °F]**

Features

Product Type Features

Connector Seal & Plug Type	Interface Seal
----------------------------	----------------

Body Features

Primary Product Material	Urethane Foam
--------------------------	---------------

Usage Conditions

Operating Temperature (Max)	90 °C[194 °F]
Operating Temperature Range	-40 – 90 °C[-40 – 194 °F]

Packaging Features

Packaging Quantity	1000
Packaging Method	Package

Product Compliance

[For compliance documentation, visit the product page on TE.com>](#)

EU RoHS Directive 2011/65/EU	Compliant
EU ELV Directive 2000/53/EC	Compliant
China RoHS 2 Directive MIIT Order No 32, 2016	No Restricted Materials Above Threshold



EU REACH Regulation (EC) No. 1907/2006

Current ECHA Candidate List: JUNE 2023 (235)

Candidate List Declared Against: JUNE 2023 (235)

Does not contain REACH SVHC

Halogen Content

Low Halogen - Br, Cl, F, I < 900 ppm per homogenous material. Also BFR/CFR/PVC Free

Solder Process Capability

Not applicable for solder process capability

Product Compliance Disclaimer

This information is provided based on reasonable inquiry of our suppliers and represents our current actual knowledge based on the information they provided. This information is subject to change. The part numbers that TE has identified as EU RoHS compliant have a maximum concentration of 0.1% by weight in homogenous materials for lead, hexavalent chromium, mercury, PBB, PBDE, DBP, BBP, DEHP, DIBP, and 0.01% for cadmium, or qualify for an exemption to these limits as defined in the Annexes of Directive 2011/65/EU (RoHS2). Finished electrical and electronic equipment products will be CE marked as required by Directive 2011/65/EU. Components may not be CE marked. Additionally, the part numbers that TE has identified as EU ELV compliant have a maximum concentration of 0.1% by weight in homogenous materials for lead, hexavalent chromium, and mercury, and 0.01% for cadmium, or qualify for an exemption to these limits as defined in the Annexes of Directive 2000/53/EC (ELV). Regarding the REACH Regulation, the information TE provides on SVHC in articles for this part number is based on the latest European Chemicals Agency (ECHA) 'Guidance on requirements for substances in articles' posted at this URL: <https://echa.europa.eu/guidance-documents/guidance-on-reach>

Compatible Parts



TE Part # 794942-1
10P MINI UMNL CAP HSG



TE Part # 1-770858-1
10P MINI UMNL HDR ASSY AU LF



TE Part # 794781-1
10P MINI UMNL PLUG HSG



TE Part # 1-770971-1
10P MINI UMNL R/A HDR ASSY LF



TE Part # 1-770971-0
10P MINI UMNL R/A HDR ASSY SN



TE Part # 1-770858-0
10P MINI UMNL HDR ASSY SNDBL L



TE Part # 1-1586359-0
10P MINIUMNL GANG WIRE SEAL DR



TE Part # 794370-1
08P MINI UMNL STR RELIEF HNGD

Also in the Series | **Mini-Universal MATE-N-LOK**

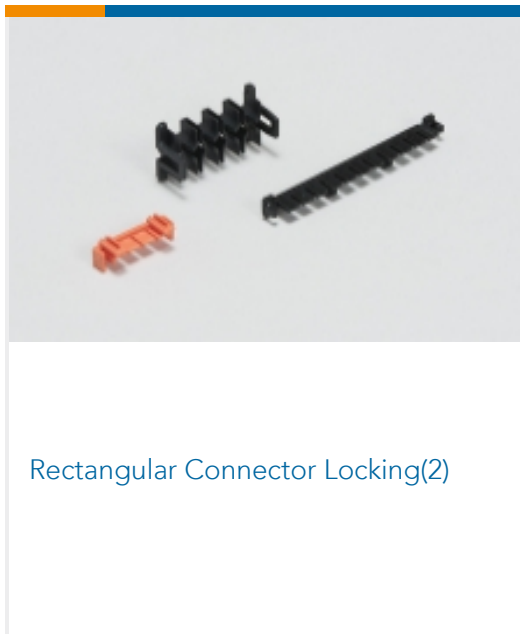
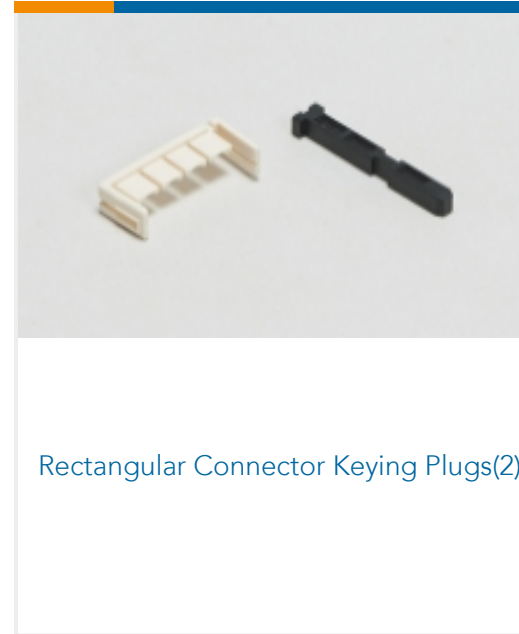
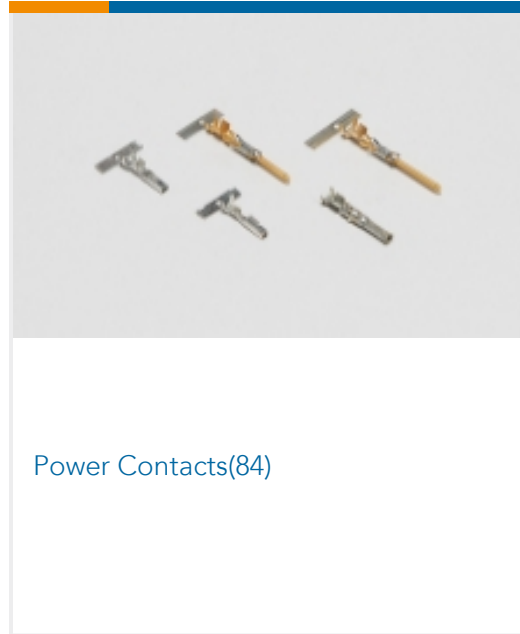
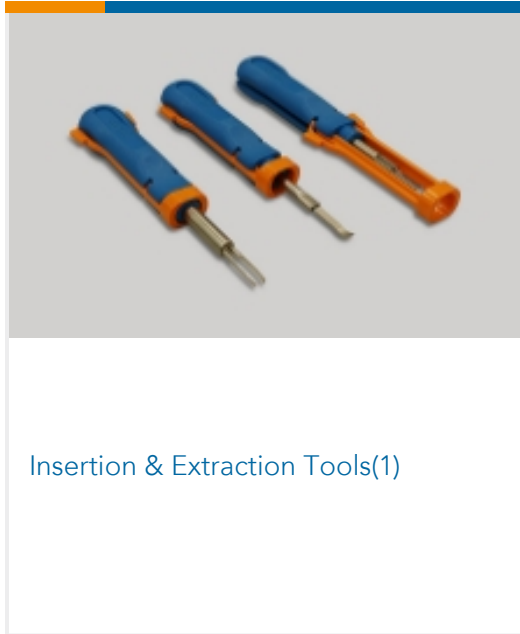
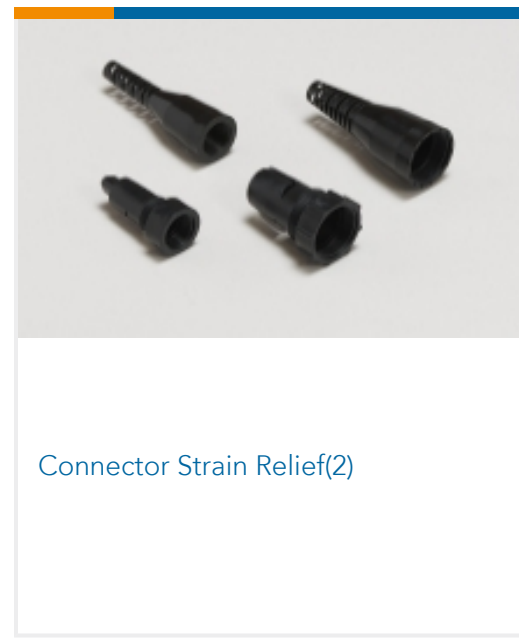
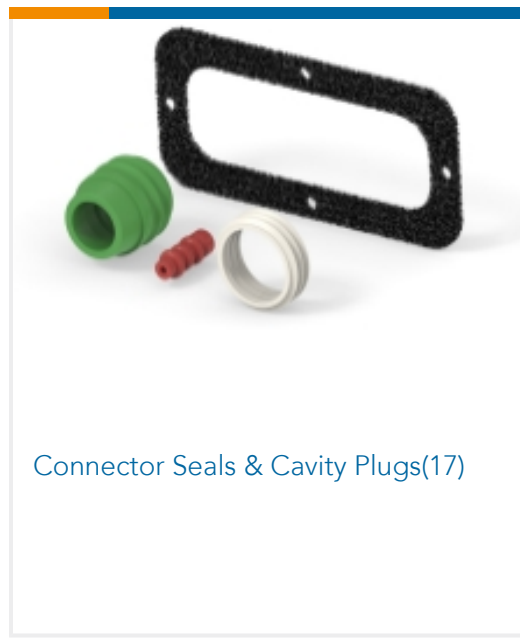
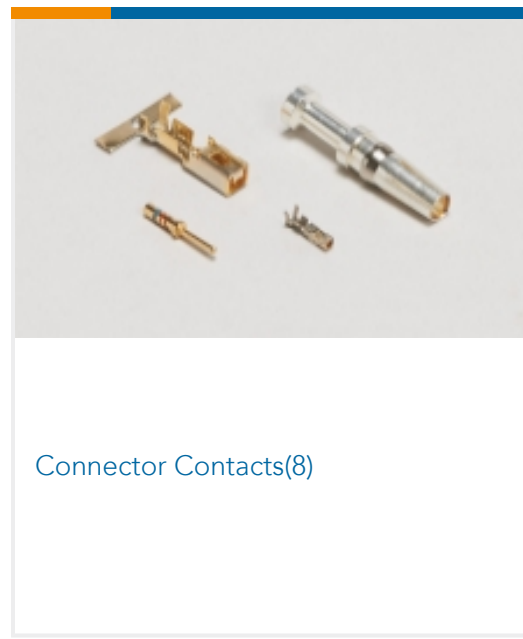
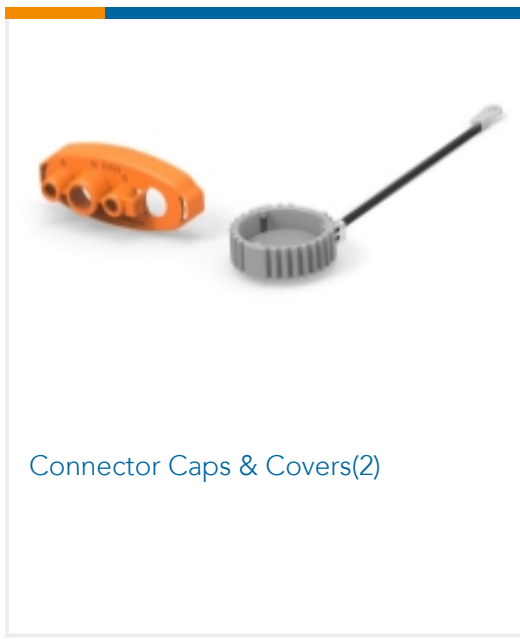

Customers Also Bought

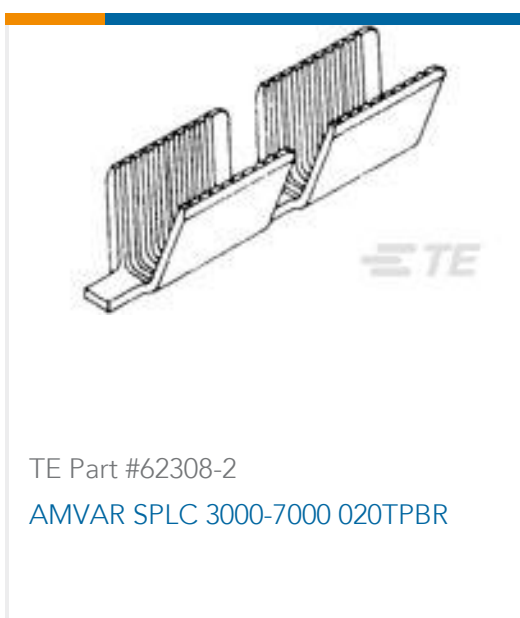



Documents

Product Drawings

10P MINI UMNL SEAL,DIE CUT

English

CAD Files

3D PDF

3D

Customer View Model

[ENG_CVM_CVM_1-794772-0_C.2d_dxf.zip](#)

English

Customer View Model

[ENG_CVM_CVM_1-794772-0_C.3d_igs.zip](#)

English

Customer View Model

[ENG_CVM_CVM_1-794772-0_C.3d_stp.zip](#)

English

By downloading the CAD file I accept and agree to the [Terms and Conditions](#) of use.

Datasheets & Catalog Pages

SOFT_SHELL_PIN_SOCKET_CONNECTORS_STANDARD_DENSITY

English

Product Specifications

Product Specification

English

Mini-Universal MATE-N-LOK* Splash Proof Seals

English

Product Specification

English

Product Specification

English

Instruction Sheets

Instruction Sheet (U.S.)

English

1-794772-0

Interface Seal, Urethane Foam, -40 – 90 °C [-40 – 194 °F] Operating Temperature,
Mini-Universal MATE-N-LOK

