

1-794223-0 ✓ ACTIVE

MATE-N-LOK | Mini-Universal MATE-N-LOK 2

TE Internal #: 1-794223-0

Power Contacts, Contact, 600 VAC, 600 VDC, Gold, 20 – 16 AWG

Wire Size, .5 – 1.4 mm<sup>2</sup> Wire Size, Wire & Cable, Crimp, Mini-

Universal MATE-N-LOK 2

[View on TE.com >](#)



Connectors > Power Connectors > Power Contacts

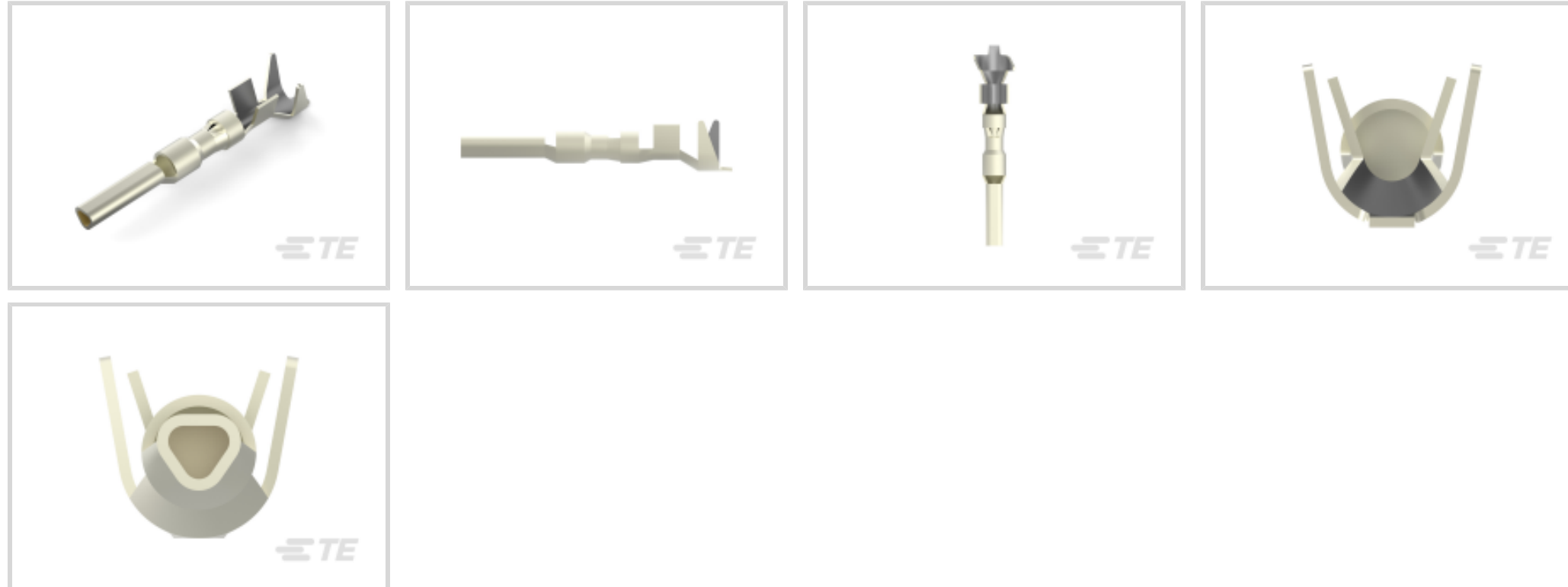

Power Contact Type: **Contact**

Operating Voltage: **600 VDC**

Contact Mating Area Plating Material: **Gold**

Wire Size: **20 – 16 AWG**

## Features

### Product Type Features

Compatible With Discrete Wire Type	Stranded
Power Contact Type	Contact
Connector & Contact Terminates To	Wire & Cable

### Electrical Characteristics

Operating Voltage	600 VDC
-------------------	---------

### Contact Features

Barrel Type	Open
Contact Mating Area Plating Material	Gold
Contact Current Rating (Max)	10.5 A
Contact Type	Socket
Contact Retention Within Housing	Without
Mating Pin Diameter	1 mm[.039 in]
Contact Base Material	Brass
Contact Mating Area Plating Material Thickness	.76 µm[30 µin]
Wire Contact Termination Area Plating Thickness	2.54 – 6.35 µm[100 – 250 µin]



Wire Contact Termination Area Plating Material	Tin
Wire Contact Termination Area Plating Material Finish	Matte
Contact Orientation	Straight
Contact Underplating Material	Nickel
Contact Underplating Material Thickness	1.27 µm[50 µin]

### Termination Features

Termination Method to Wire & Cable	Crimp
------------------------------------	-------

### Mechanical Attachment

Wire Insulation Support	Without
-------------------------	---------

### Dimensions

Wire Size	.5 – 1.4 mm <sup>2</sup>
Compatible Insulation Diameter Range	2.01 – 3.2 mm[.079 – .126 in]

### Usage Conditions

Operating Temperature Range	-55 – 105 °C[-67 – 221 °F]
-----------------------------	----------------------------

### Operation/Application

Circuit Application	Power
---------------------	-------

### Industry Standards

CSA Rating	Certified, LR 7189
UL Rating	Recognized
Agency/Standard	CSA, UL

### Packaging Features

Packaging Quantity	5000
Packaging Method	Reel

### Product Compliance

[For compliance documentation, visit the product page on TE.com>](#)

EU RoHS Directive 2011/65/EU	Compliant
EU ELV Directive 2000/53/EC	Compliant
China RoHS 2 Directive MIIT Order No 32, 2016	No Restricted Materials Above Threshold
EU REACH Regulation (EC) No. 1907/2006	Current ECHA Candidate List: JUNE 2023 (235) Candidate List Declared Against: JUNE 2023 (235)

Does not contain REACH SVHC

Halogen Content

Low Halogen - Br, Cl, F, I < 900 ppm per homogenous material. Also BFR/CFR/PVC Free

Solder Process Capability

Not applicable for solder process capability

Product Compliance Disclaimer

This information is provided based on reasonable inquiry of our suppliers and represents our current actual knowledge based on the information they provided. This information is subject to change. The part numbers that TE has identified as EU RoHS compliant have a maximum concentration of 0.1% by weight in homogenous materials for lead, hexavalent chromium, mercury, PBB, PBDE, DBP, BBP, DEHP, DIBP, and 0.01% for cadmium, or qualify for an exemption to these limits as defined in the Annexes of Directive 2011/65/EU (RoHS2). Finished electrical and electronic equipment products will be CE marked as required by Directive 2011/65/EU. Components may not be CE marked. Additionally, the part numbers that TE has identified as EU ELV compliant have a maximum concentration of 0.1% by weight in homogenous materials for lead, hexavalent chromium, and mercury, and 0.01% for cadmium, or qualify for an exemption to these limits as defined in the Annexes of Directive 2000/53/EC (ELV). Regarding the REACH Regulation, the information TE provides on SVHC in articles for this part number is based on the latest European Chemicals Agency (ECHA) 'Guidance on requirements for substances in articles' posted at this URL: <https://echa.europa.eu/guidance-documents/guidance-on-reach>

## Compatible Parts



TE Part # 189727-1  
EXTRACTION TOOL



TE Part # 455830-1  
INSERTION TOOL



TE Part # 794215-1  
24P MINI UMNL2 CAP HSG UL94V0



TE Part # 794200-1  
12P MINI UMNL2 PLUG HSG MATRIX



TE Part # 794198-1  
12P MINI UMNL2 PLUG HSG DBLROW



TE Part # 794206-1  
16P MINI UMNL2 PLUG HSG UL94V0



TE Part # 794194-1  
09P MINI UMNL2 PLUG HSG UL94V0



TE Part # 794187-1  
03P MINI UMNL2 CAP HSG UL94V0



TE Part # 794205-1  
15P MINI UMNL2 CAP HSG UL94V0



TE Part # 794191-1  
06P MINI UMNL2 CAP HSG UL94V0



TE Part # 794196-1  
10P MINI UMNL2 PLUG HSG UL94V0



TE Part # 794192-1  
08P MINI UMNL2 PLUG HSG UL94V0



## Also in the Series | Mini-Universal MATE-N-LOK 2

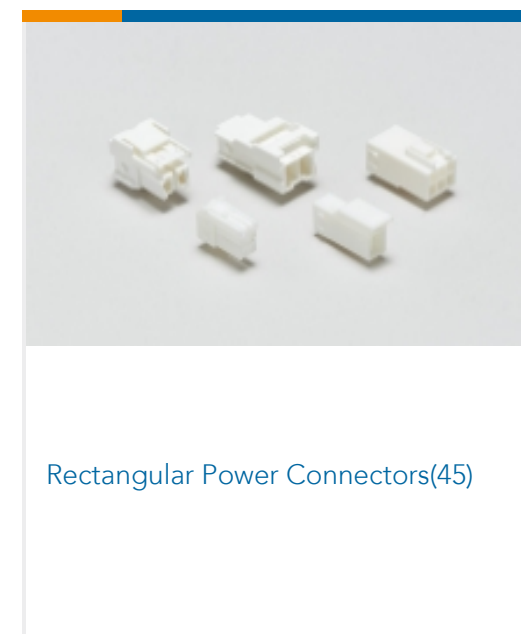
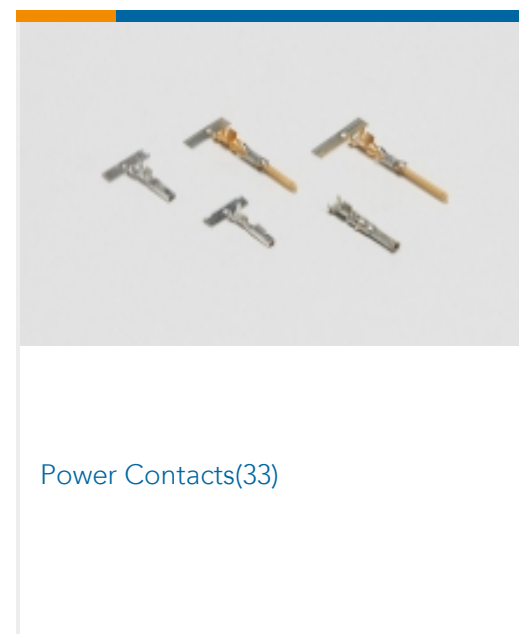
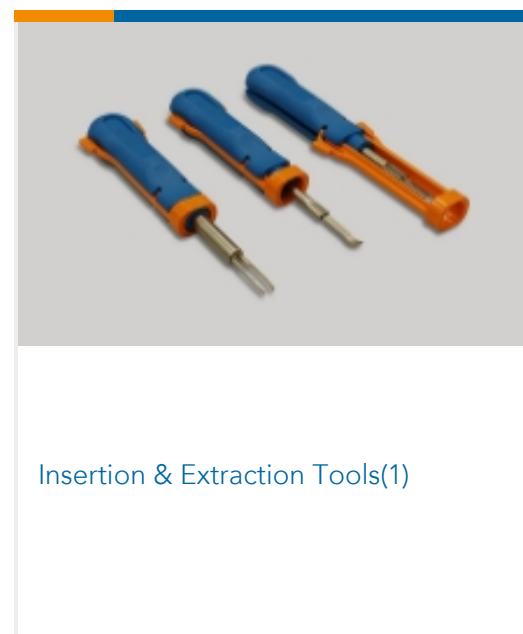
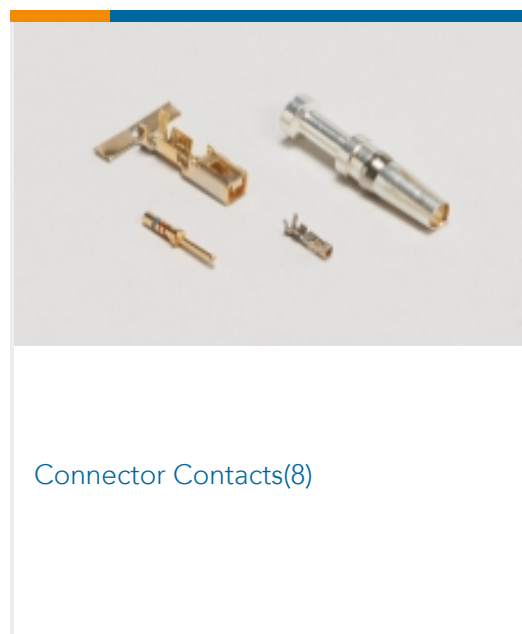

## Customers Also Bought

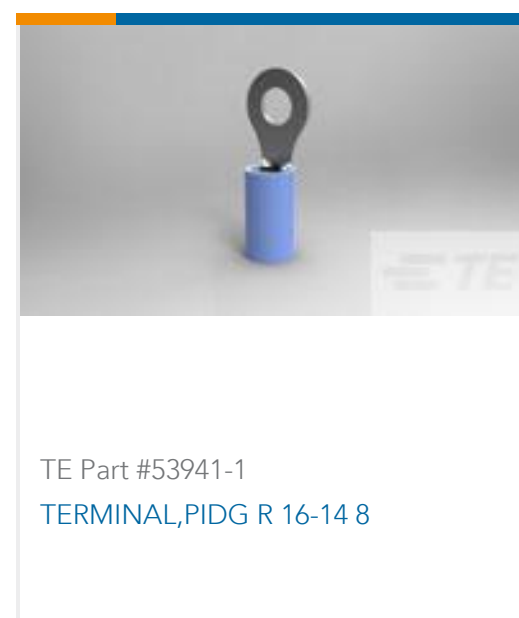
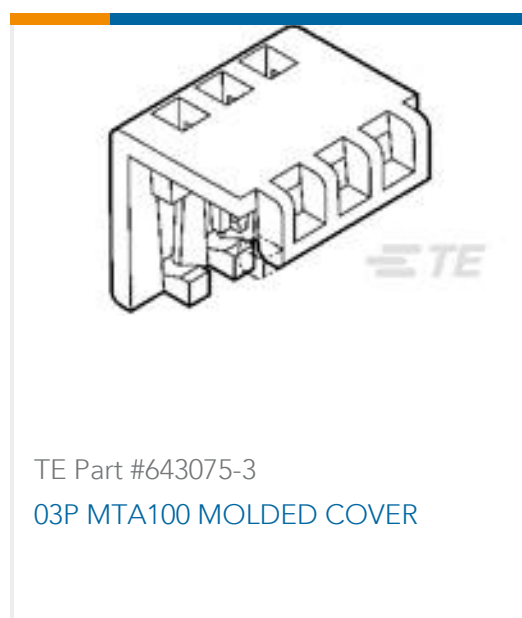



## Documents

### Product Drawings

[MINI UMNL2 SCKT 20-16AWG 30AU](#)

English

### CAD Files

[3D PDF](#)

3D

Customer View Model

[ENG\\_CVM\\_CVM\\_1-794223-0\\_P.2d\\_dxf.zip](#)

English

Customer View Model

[ENG\\_CVM\\_CVM\\_1-794223-0\\_P.3d\\_igs.zip](#)

English

Customer View Model

[ENG\\_CVM\\_CVM\\_1-794223-0\\_P.3d\\_stp.zip](#)

English

By downloading the CAD file I accept and agree to the [Terms and Conditions](#) of use.

### Datasheets & Catalog Pages

[SOFT\\_SHELL\\_PIN\\_AND\\_SOCKET\\_CONNECTORS\\_CATALOG](#)

English

### Product Specifications

[Product Specification](#)

English

[Mini UMNL II Header](#)

English

### Product Environmental Compliance

[MD\\_1-794223-0\\_04072011235](#)

English

[MD\\_1-794223-0\\_04072011235](#)

English