

1-770902-1 ✓ ACTIVE

MATE-N-LOK | Mini-Universal MATE-N-LOK

TE Internal #: 1-770902-1

Power Contacts, Contact, 600 VAC, 600 VDC, Gold, 26 – 22 AWG

Wire Size, .12 – .4 mm<sup>2</sup> Wire Size, Wire & Cable, Crimp, Power, Mini-

Universal MATE-N-LOK

[View on TE.com >](#)



Connectors > Power Connectors > Power Contacts



Power Contact Type: **Contact**

Operating Voltage: **600 VDC**

Contact Mating Area Plating Material: **Gold**

Wire Size: **26 – 22 AWG**

## Features

### Product Type Features

Compatible With Discrete Wire Type	Stranded
Power Contact Type	Contact
Connector & Contact Terminates To	Wire & Cable

### Electrical Characteristics

Operating Voltage	600 VDC
-------------------	---------

### Contact Features

Contact Mating Area Plating Material	Gold
Contact Current Rating (Max)	11.2 A
Contact Type	Socket
Contact Retention Within Housing	With
Mating Pin Diameter	1 mm [.039 in]
Contact Base Material	Phosphor Bronze
Contact Mating Area Plating Material Thickness	.76 μm [30 μin]
Wire Contact Termination Area Plating Thickness	2.54 μm [100 μin]
Wire Contact Termination Area Plating Material	Tin



Wire Contact Termination Area Plating Material Finish	Bright
Contact Orientation	Straight
Contact Underplating Material	Nickel
Contact Underplating Material Thickness	1.27 µm[50 µin]

### Termination Features

Termination Method to Wire & Cable	Crimp
------------------------------------	-------

### Mechanical Attachment

Wire Insulation Support	Without
-------------------------	---------

### Dimensions

Wire Size	.12 – .4 mm <sup>2</sup>
Compatible Insulation Diameter Range	1.19 – 1.75 mm[.047 – .069 in]

### Usage Conditions

Operating Temperature Range	-55 – 105 °C[-67 – 221 °F]
-----------------------------	----------------------------

### Operation/Application

Circuit Application	Power
---------------------	-------

### Industry Standards

CSA Rating	Certified, LR 7189
UL Rating	Recognized
Agency/Standard	CSA, UL
UL Flammability Rating	UL 94V-0

### Packaging Features

Packaging Quantity	7000
Packaging Method	Reel

### Other

Power Connectors Comment	HDM Applicator part number ending in -3 is used on AMPOMATOR CLS Machine with T or G Terminators, -4 is used on AMP-O-LECTRIC Model K Machine, -5 is used on AMP-O-LECTRIC Model G Machines.
--------------------------	--

### Product Compliance

For compliance documentation, visit the product page on [TE.com](https://www.te.com)>

EU RoHS Directive 2011/65/EU	Compliant
------------------------------	-----------



EU ELV Directive 2000/53/EC	Compliant
China RoHS 2 Directive MIIT Order No 32, 2016	No Restricted Materials Above Threshold
EU REACH Regulation (EC) No. 1907/2006	Current ECHA Candidate List: JUNE 2023 (235) Candidate List Declared Against: JUNE 2023 (235) Does not contain REACH SVHC
Halogen Content	Low Halogen - Br, Cl, F, I < 900 ppm per homogenous material. Also BFR/CFR/PVC Free
Solder Process Capability	Not applicable for solder process capability

Product Compliance Disclaimer

This information is provided based on reasonable inquiry of our suppliers and represents our current actual knowledge based on the information they provided. This information is subject to change. The part numbers that TE has identified as EU RoHS compliant have a maximum concentration of 0.1% by weight in homogenous materials for lead, hexavalent chromium, mercury, PBB, PBDE, DBP, BBP, DEHP, DIBP, and 0.01% for cadmium, or qualify for an exemption to these limits as defined in the Annexes of Directive 2011/65/EU (RoHS2). Finished electrical and electronic equipment products will be CE marked as required by Directive 2011/65/EU. Components may not be CE marked. Additionally, the part numbers that TE has identified as EU ELV compliant have a maximum concentration of 0.1% by weight in homogenous materials for lead, hexavalent chromium, and mercury, and 0.01% for cadmium, or qualify for an exemption to these limits as defined in the Annexes of Directive 2000/53/EC (ELV). Regarding the REACH Regulation, the information TE provides on SVHC in articles for this part number is based on the latest European Chemicals Agency (ECHA) 'Guidance on requirements for substances in articles' posted at this URL: <https://echa.europa.eu/guidance-documents/guidance-on-reach>

## Compatible Parts

TE Part # CAT-AM71-C83998EE  
Mini Circular Plastic Connectors (CPC)

TE Part # 91529-1  
CCII MINI-UMNL PIN 26-22 ASSY

TE Part # 90758-2  
PROCRIMP DIE MINI UNIV MNL

TE Part # 189727-1  
EXTRACTION TOOL

TE Part # 455830-1  
INSERTION TOOL

TE Part # 770586-1  
22P MINI UMNL PLUG HSG

TE Part # 794942-1  
10P MINI UMNL CAP HSG

TE Part # 770587-1  
24P MINI UMNL PLUG HSG



## Also in the Series | Mini-Universal MATE-N-LOK

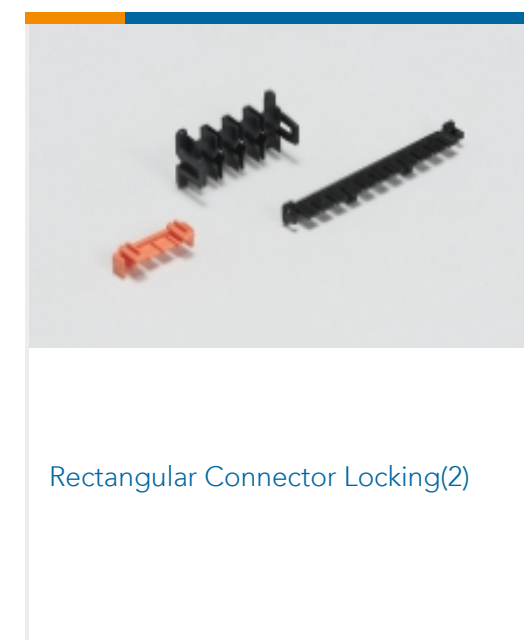
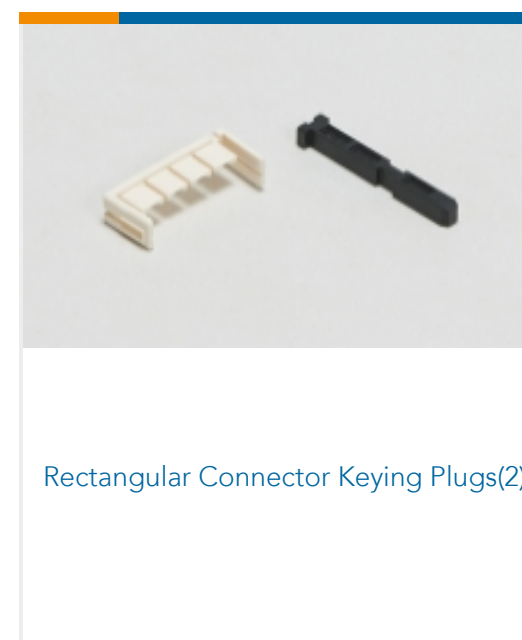
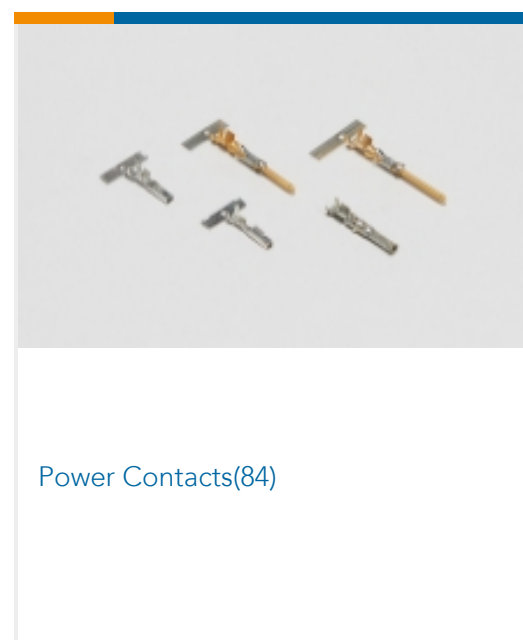
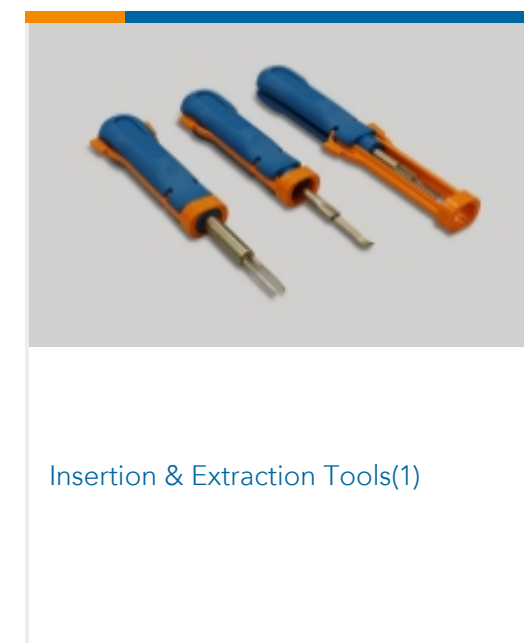
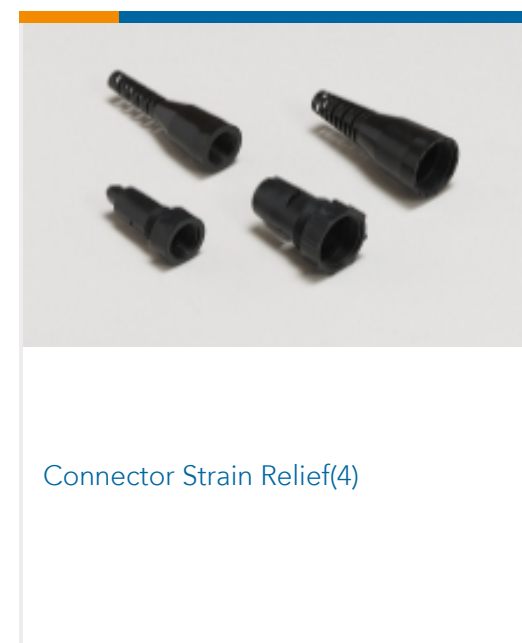
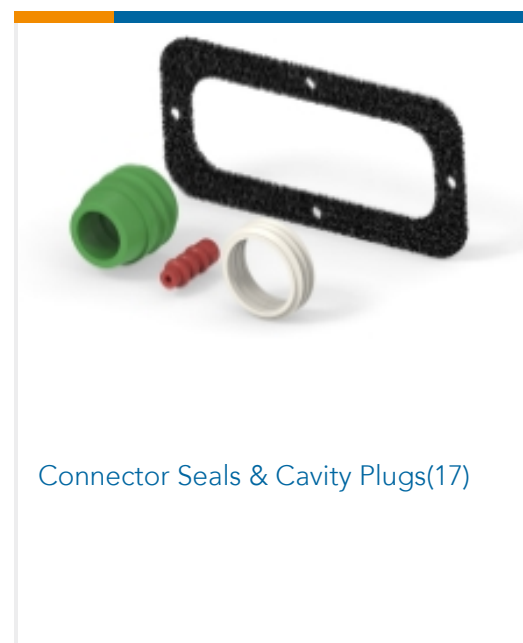
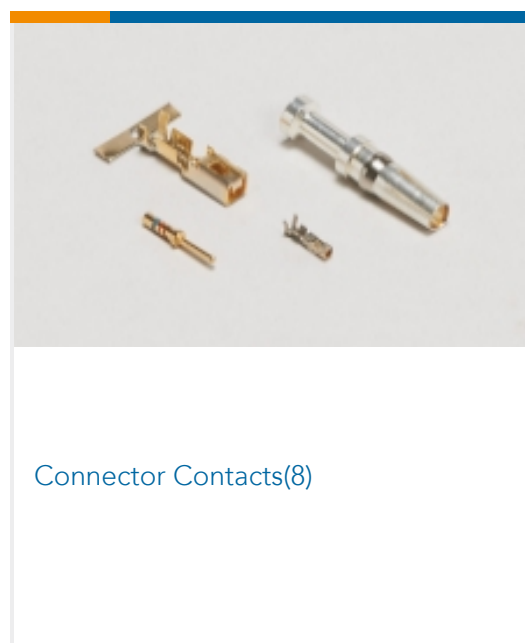





Rectangular Power Connectors(244)

## Customers Also Bought

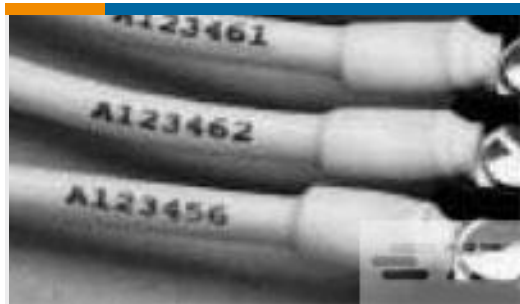

TE Part #F75818-000  
RNF-100-MINI-SPL-1/4-BK



TE Part #53041  
TERMINAL,T-N R 8 8



TE Part #3-794618-2  
02P MICRO MNL ASSY R/A HDR LF



TE Part #34151  
PG R 22-16 COMM 22-18 MIL 5/16

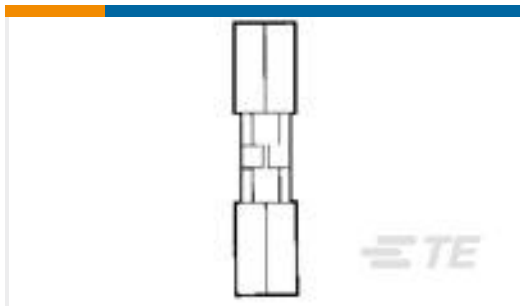

TE Part #324001  
SPLICE,SOLIS BUTT STRAP 24-20

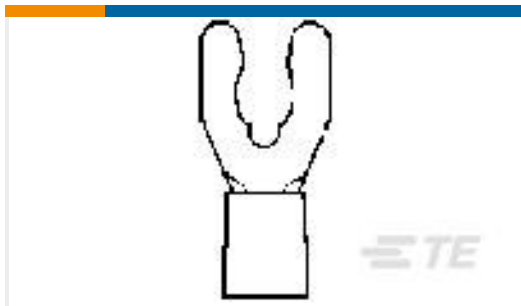

TE Part #52950-1  
PG SPR SPD 22-16COMM22-18MIL 8



TE Part #171508-5  
PIDG RING UL.CSA(22-16)

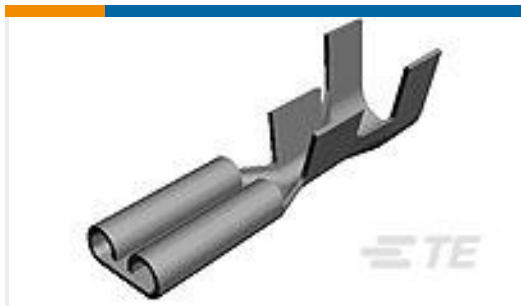

TE Part #342368-2  
187 FASTON,REC.,30-24 AWG,TPBR



TE Part #NB20344001  
VERSAFIT-3/16-2-SP



TE Part #693597-1  
EXTRACTION TOOL

## Documents

### Product Drawings

[MINI UMNL SOK 26-22 AWG AU LF](#)

English

### CAD Files

Customer View Model

[ENG\\_CVM\\_CVM\\_1-770902-1\\_T.2d\\_dxf.zip](#)

English

[3D PDF](#)



3D

Customer View Model

[ENG\\_CVM\\_CVM\\_1-770902-1\\_T.3d\\_igs.zip](#)

English

Customer View Model

[ENG\\_CVM\\_CVM\\_1-770902-1\\_T.3d\\_stp.zip](#)

English

By downloading the CAD file I accept and agree to the [Terms and Conditions](#) of use.

---

### Datasheets & Catalog Pages

[AMP Circular Connectors for Commercial Signal & Power Applications Continued](#)

English

[SOFT\\_SHELL\\_PIN\\_AND\\_SOCKET\\_CONNECTORS\\_CATALOG](#)

English

---

### Product Specifications

[Application Specification](#)

English

---

### Product Environmental Compliance

[MD\\_1-770902-1\\_07022013727\\_dmtec](#)

English

[MD\\_1-770902-1\\_07022013727\\_dmtec](#)

English

---

### Instruction Sheets

[Instruction Sheet \(U.S.\)](#)

English