

1-770835-0 ✓ ACTIVE

MATE-N-LOK | Mini-Universal MATE-N-LOK

TE Internal #: 1-770835-0

Power Contacts, Contact, 600 VAC, 600 VDC, Gold, 30 – 26 AWG

Wire Size, .05 – .15 mm² Wire Size, Wire & Cable, Crimp, Power,

Mini-Universal MATE-N-LOK

[View on TE.com >](#)



Connectors > Power Connectors > Power Contacts



Power Contact Type: **Contact**

Operating Voltage: **600 VDC**

Contact Mating Area Plating Material: **Gold**

Wire Size: **30 – 26 AWG**

Features

Product Type Features

Compatible With Discrete Wire Type	Stranded
Power Contact Type	Contact
Connector & Contact Terminates To	Wire & Cable

Electrical Characteristics

Operating Voltage	600 VDC
-------------------	---------

Contact Features

Contact Mating Area Plating Material	Gold
Contact Current Rating (Max)	11.2 A
Contact Type	Pin
Contact Retention Within Housing	With
Mating Pin Diameter	1 mm [.039 in]
Contact Base Material	Brass
Contact Mating Area Plating Material Thickness	.76 µm [30 µin]
Wire Contact Termination Area Plating Thickness	2.54 µm [100 µin]
Wire Contact Termination Area Plating Material	Tin



Wire Contact Termination Area Plating Material Finish	Matte
Contact Orientation	Straight
Contact Underplating Material	Nickel
Contact Underplating Material Thickness	1.27 µm[50 µin]

Termination Features

Termination Method to Wire & Cable	Crimp
------------------------------------	-------

Mechanical Attachment

Wire Insulation Support	Without
-------------------------	---------

Dimensions

Wire Size	.05 – .15 mm ²
Compatible Insulation Diameter Range	.89 – 1.27 mm[.035 – .05 in]

Usage Conditions

Operating Temperature Range	-55 – 105 °C[-67 – 221 °F]
-----------------------------	----------------------------

Operation/Application

Circuit Application	Power
---------------------	-------

Industry Standards

CSA Rating	Certified, LR 7189
UL Rating	Recognized
Agency/Standard	CSA, UL
UL Flammability Rating	UL 94V-0

Packaging Features

Packaging Quantity	10000
Packaging Method	Reel

Other

Power Connectors Comment	HDM Applicator part number ending in -1 is used on AMPOMATOR CLS Machine with T or G Terminators, -2 is used on AMP-O-LECTRIC Model K Machine, -3 is used on AMP-O-LECTRIC Model G Machine.
--------------------------	---

Product Compliance

For compliance documentation, visit the product page on [TE.com](https://www.te.com)>









EU RoHS Directive 2011/65/EU	Compliant
------------------------------	-----------

EU ELV Directive 2000/53/EC	Compliant
China RoHS 2 Directive MIIT Order No 32, 2016	No Restricted Materials Above Threshold
EU REACH Regulation (EC) No. 1907/2006	Current ECHA Candidate List: JUNE 2023 (235) Candidate List Declared Against: JUNE 2023 (235) Does not contain REACH SVHC
Halogen Content	Low Halogen - Br, Cl, F, I < 900 ppm per homogenous material. Also BFR/CFR/PVC Free
Solder Process Capability	Not reviewed for solder process capability

Product Compliance Disclaimer

This information is provided based on reasonable inquiry of our suppliers and represents our current actual knowledge based on the information they provided. This information is subject to change. The part numbers that TE has identified as EU RoHS compliant have a maximum concentration of 0.1% by weight in homogenous materials for lead, hexavalent chromium, mercury, PBB, PBDE, DBP, BBP, DEHP, DIBP, and 0.01% for cadmium, or qualify for an exemption to these limits as defined in the Annexes of Directive 2011/65/EU (RoHS2). Finished electrical and electronic equipment products will be CE marked as required by Directive 2011/65/EU. Components may not be CE marked. Additionally, the part numbers that TE has identified as EU ELV compliant have a maximum concentration of 0.1% by weight in homogenous materials for lead, hexavalent chromium, and mercury, and 0.01% for cadmium, or qualify for an exemption to these limits as defined in the Annexes of Directive 2000/53/EC (ELV). Regarding the REACH Regulation, the information TE provides on SVHC in articles for this part number is based on the latest European Chemicals Agency (ECHA) 'Guidance on requirements for substances in articles' posted at this URL: <https://echa.europa.eu/guidance-documents/guidance-on-reach>

Compatible Parts

 <p>TE Part # CAT-AM71-C83998EE Mini Circular Plastic Connectors (CPC)</p>	 <p>TE Part # 189727-1 EXTRACTION TOOL</p>	 <p>TE Part # 455830-1 INSERTION TOOL</p>	 <p>TE Part # 770586-1 22P MINI UMNL PLUG HSG</p>
 <p>TE Part # 770587-1 24P MINI UMNL PLUG HSG</p>	 <p>TE Part # 770582-1 14P MINI UMNL PLUG HSG</p>	 <p>TE Part # 770585-1 20P MINI UMNL PLUG HSG</p>	 <p>TE Part # 172333-1 MINI UNIVERSAL M-N-L HOUSING</p>



Also in the Series | Mini-Universal MATE-N-LOK

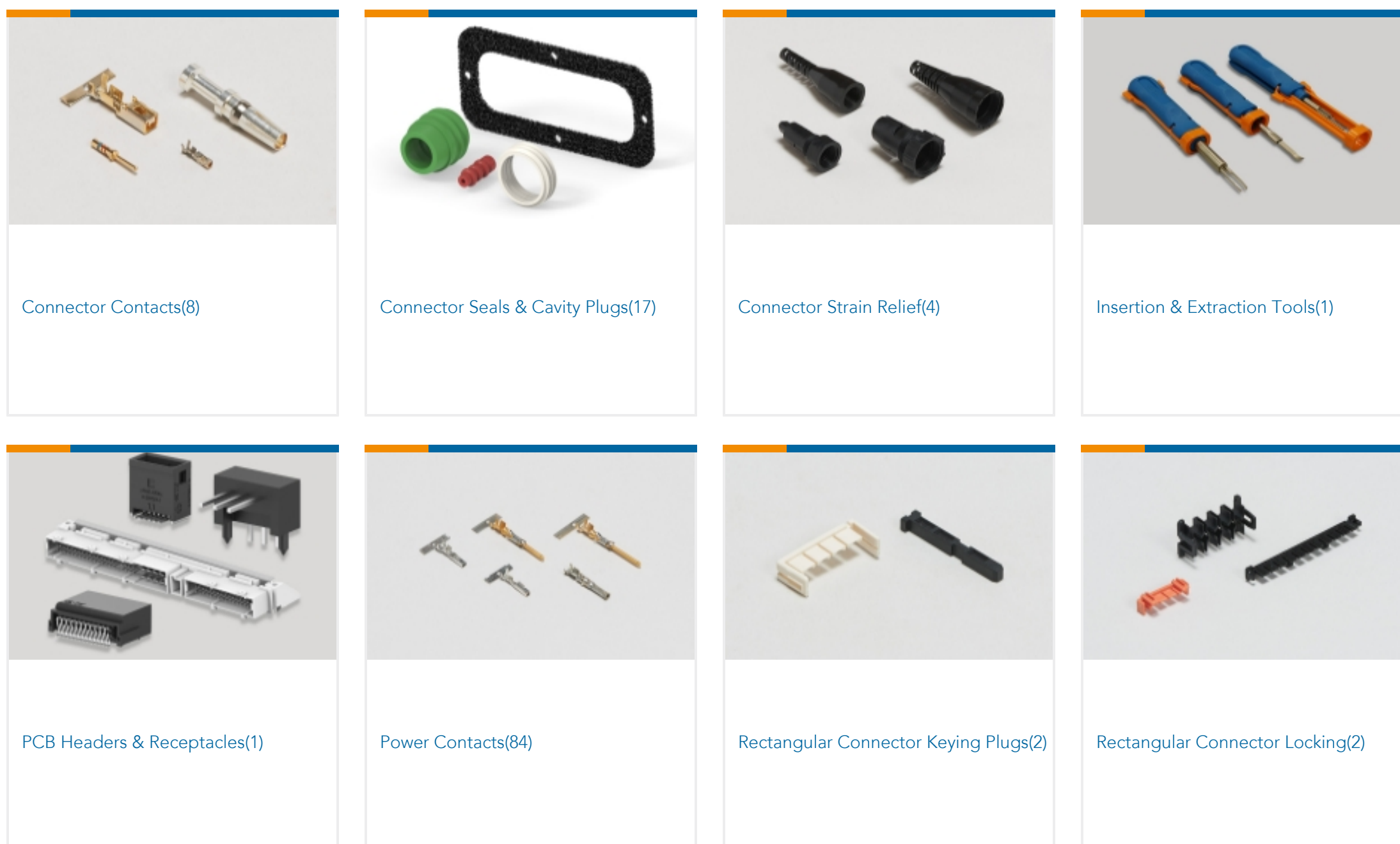



Rectangular Power Connectors(244)

Customers Also Bought



TE Part #50865
SOCKET,MIN-SPR AU SER-4



TE Part #3-2176231-9
3522 390R 1% 3W

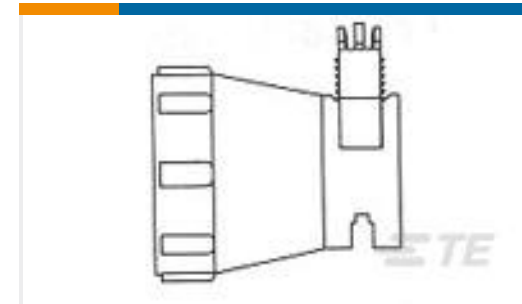

TE Part #1445730-1
STRN RELIEF ASY,STRT SIZE 8



TE Part #1-111196-8
20 RCPT SYSTEM 50, LEAD FREE

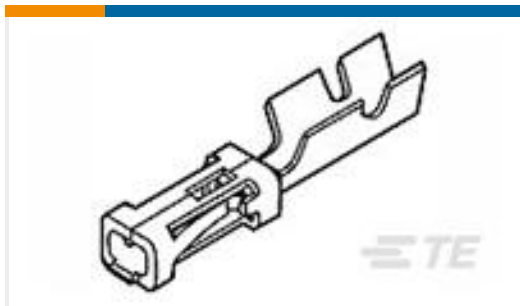

TE Part #102917-1
MOD IV RECP PLTD 30 SEL



TE Part #350561-7
UMNL PIN 24-18 .0126 AU/NI/BR

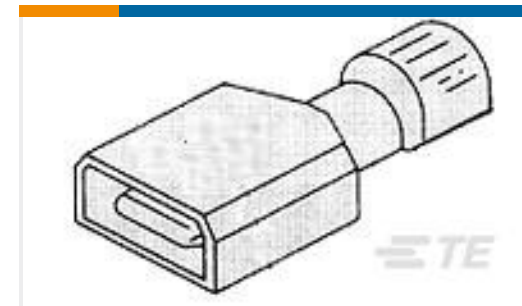

TE Part #2-521144-2
ULTRA-FAST 250 ASY TAB 22-18 TPBR



TE Part #224150-E
M08 F 3 A H S * 207 16,3 094 * * * * 000

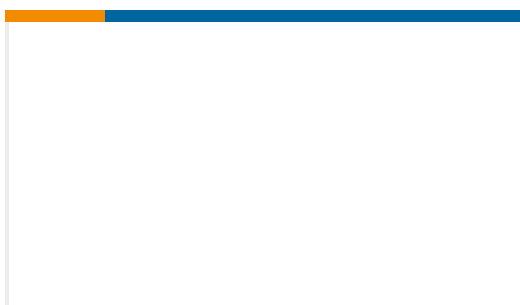

TE Part #254370-E
STVB/3 20 F AB VV 7-00 TL 4,0 * 247 E007



TE Part #494828-E
STVB/3 14 M AB 0539 4-00 0606 * * 247 E0

Documents

Product Drawings

[MINI UMNL PIN AU LF](#)

English

CAD Files

[3D PDF](#)

English

Customer View Model

[ENG_CVM_1-770835-0_H.3d_igs.zip](#)



English

Customer View Model

[ENG_CVM_1-770835-0_H.3d_stp.zip](#)

English

Customer View Model

[ENG_CVM_1-770835-0_H.2d_dxf.zip](#)

English

3D PDF

3D

Customer View Model

[ENG_CVM_CVM_1-770835-0_M.2d_dxf.zip](#)

English

Customer View Model

[ENG_CVM_CVM_1-770835-0_M.3d_igs.zip](#)

English

Customer View Model

[ENG_CVM_CVM_1-770835-0_M.3d_stp.zip](#)

English

By downloading the CAD file I accept and agree to the [Terms and Conditions](#) of use.

Datasheets & Catalog Pages

[AMP Circular Connectors for Commercial Signal & Power Applications Continued](#)

English

[SOFT_SHELL_PIN_AND_SOCKET_CONNECTORS_CATALOG](#)

English

Product Specifications

[Application Specification](#)

English

Product Environmental Compliance

[Product Compliance](#)

English

[Product Compliance](#)

English

Instruction Sheets

[Instruction Sheet \(U.S.\)](#)

English