

1-770007-0 ✓ ACTIVE

MATE-N-LOK | Universal MATE-N-LOK

TE Internal #: 1-770007-0

Power Contacts, Contact, 600 VAC, Gold, 20 – 14 AWG Wire Size, .

5 – 2 mm² Wire Size, Wire & Cable, Crimp, Power, Pin, Universal

MATE-N-LOK

[View on TE.com >](#)



Connectors > Power Connectors > Power Contacts



Power Contact Type: **Contact**

Operating Voltage: **600 VAC**

Contact Mating Area Plating Material: **Gold**

Wire Size: **.5 – 2 mm²**

Features

Product Type Features

Compatible With Discrete Wire Type	Stranded
Power Contact Type	Contact
Connector & Contact Terminates To	Wire & Cable

Electrical Characteristics

Operating Voltage	600 VAC
-------------------	---------

Contact Features

Contact Mating Area Plating Material	Gold
Contact Current Rating (Max)	7 A
Contact Type	Pin
Contact Retention Within Housing	Without
Mating Pin Diameter	2.18 mm[.086 in]
Contact Base Material	Brass
Contact Mating Area Plating Material Thickness	.76 µm[30 µin]
Wire Contact Termination Area Plating Thickness	1.27 µm[50 µin]
Wire Contact Termination Area Plating Material	Tin



Contact Orientation	Straight
Contact Underplating Material	Nickel
Contact Underplating Material Thickness	1.27 µm[50 µin]

Termination Features

Termination Method to Wire & Cable	Crimp
------------------------------------	-------

Mechanical Attachment

Wire Insulation Support	Without
-------------------------	---------

Dimensions

Wire Size	.5 – 2 mm ²
Compatible Insulation Diameter Range	1.52 – 3.3 mm[.06 – .13 in]

Usage Conditions

Operating Temperature Range	-55 – 120 °C[-67 – 248 °F]
-----------------------------	----------------------------

Operation/Application

Circuit Application	Power
---------------------	-------

Industry Standards

CSA Rating	Certified, LR 7189
UL Rating	Recognized
Agency/Standard	CSA, UL, VDE

Packaging Features

Packaging Quantity	4000
Packaging Method	Reel

Product Compliance

[For compliance documentation, visit the product page on TE.com>](#)

EU RoHS Directive 2011/65/EU	Compliant
EU ELV Directive 2000/53/EC	Compliant
China RoHS 2 Directive MIIT Order No 32, 2016	No Restricted Materials Above Threshold
EU REACH Regulation (EC) No. 1907/2006	Current ECHA Candidate List: JUNE 2023 (235) Candidate List Declared Against: JAN 2023 (233) Does not contain REACH SVHC
Halogen Content	Low Halogen - Br, Cl, F, I < 900 ppm per

homogenous material. Also BFR/CFR/PVC Free

Solder Process Capability

Not applicable for solder process capability

Product Compliance Disclaimer

This information is provided based on reasonable inquiry of our suppliers and represents our current actual knowledge based on the information they provided. This information is subject to change. The part numbers that TE has identified as EU RoHS compliant have a maximum concentration of 0.1% by weight in homogenous materials for lead, hexavalent chromium, mercury, PBB, PBDE, DBP, BBP, DEHP, DIBP, and 0.01% for cadmium, or qualify for an exemption to these limits as defined in the Annexes of Directive 2011/65/EU (RoHS2). Finished electrical and electronic equipment products will be CE marked as required by Directive 2011/65/EU. Components may not be CE marked. Additionally, the part numbers that TE has identified as EU ELV compliant have a maximum concentration of 0.1% by weight in homogenous materials for lead, hexavalent chromium, and mercury, and 0.01% for cadmium, or qualify for an exemption to these limits as defined in the Annexes of Directive 2000/53/EC (ELV). Regarding the REACH Regulation, the information TE provides on SVHC in articles for this part number is based on the latest European Chemicals Agency (ECHA) 'Guidance on requirements for substances in articles' posted at this URL: <https://echa.europa.eu/guidance-documents/guidance-on-reach>

Compatible Parts



TE Part # 90546-1
ASSY PRO-CRIMPER UNIV M-N-L



TE Part # 91500-1
CCII UNML UNML II PIN SKT 20-14 ASSY

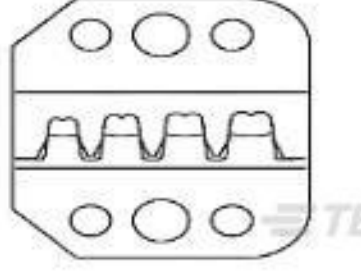

TE Part # 90546-2
PROCRIMPER DIE ASSY UNIV MNL



TE Part # 770022-1
12P UMNLI IN-LNE PLUG HSG KIT



TE Part # 770019-1
04P UMNLI IN-LNE PLUG HSG KIT



TE Part # 770028-1
09P UMNLI IN-LINE CAP HSG KIT



TE Part # 770026-1
04P UMNLI IN-LINE CAP HSG KIT



TE Part # 770024-1
02P UMNLI IN-LINE CAP HSG KIT



TE Part # 770029-1
12P UMNLI IN-LINE CAP HSG KIT



TE Part # 770021-1
09P UMNLI IN-LNE PLUG HSG KIT



TE Part # 770030-1
15P UMNLI IN-LINE CAP HSG KIT



TE Part # 770018-1
03P UMNLI IN-LNE PLUG HSG KIT



Also in the Series | Universal MATE-N-LOK

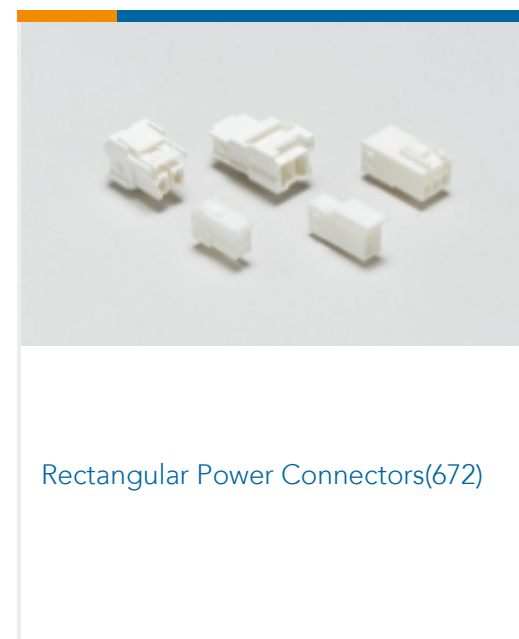
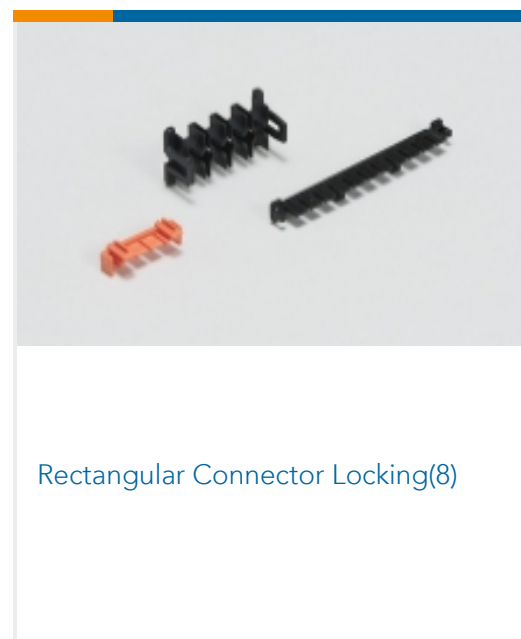
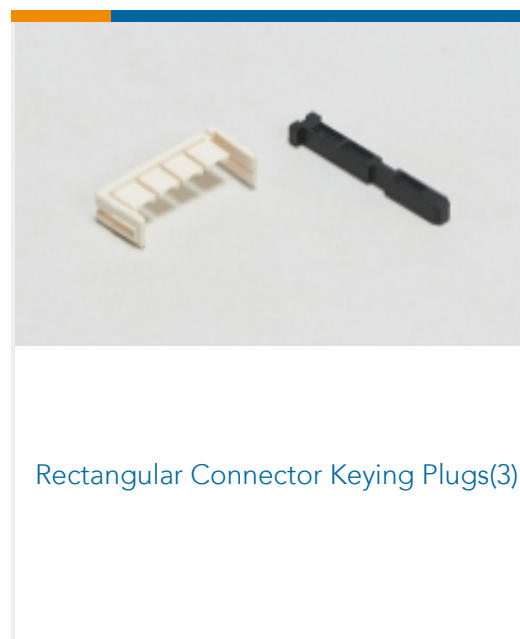
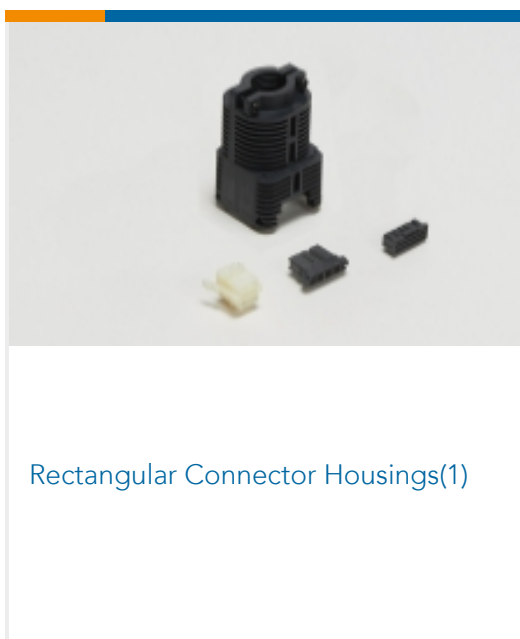
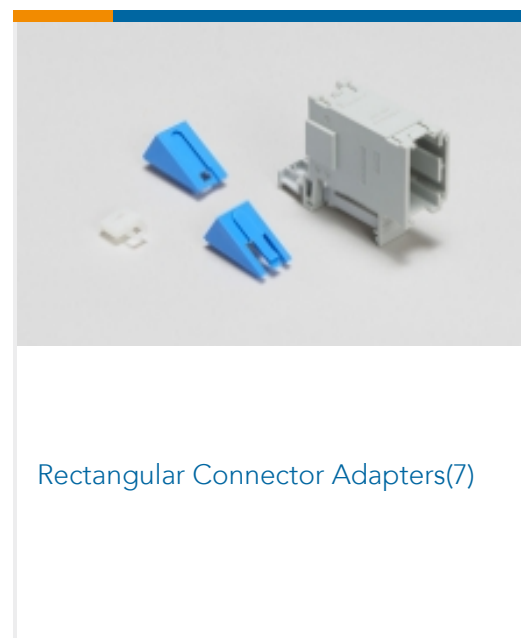
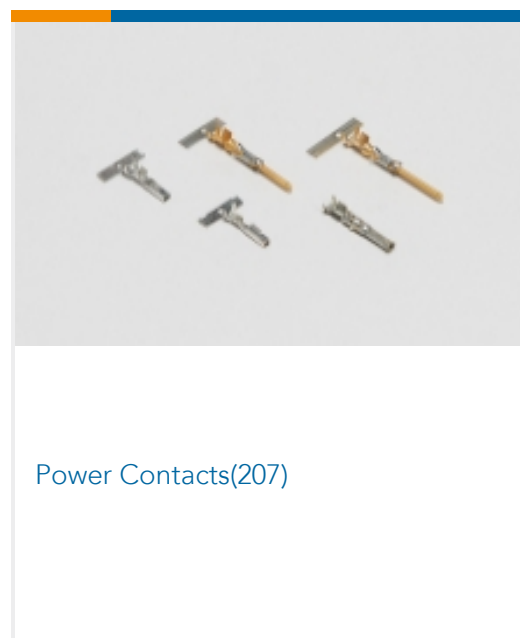
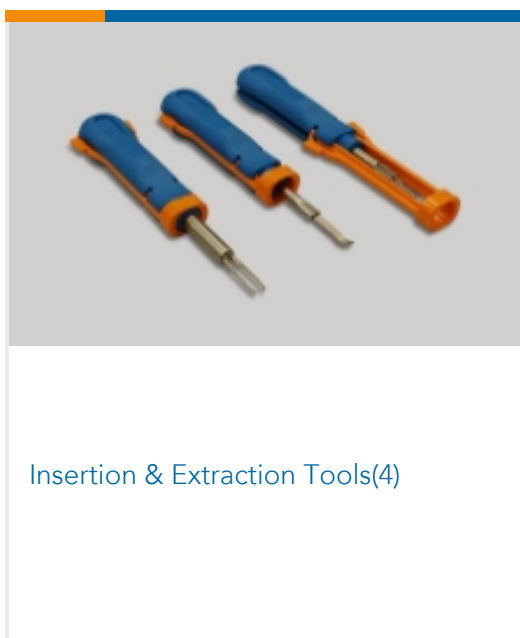
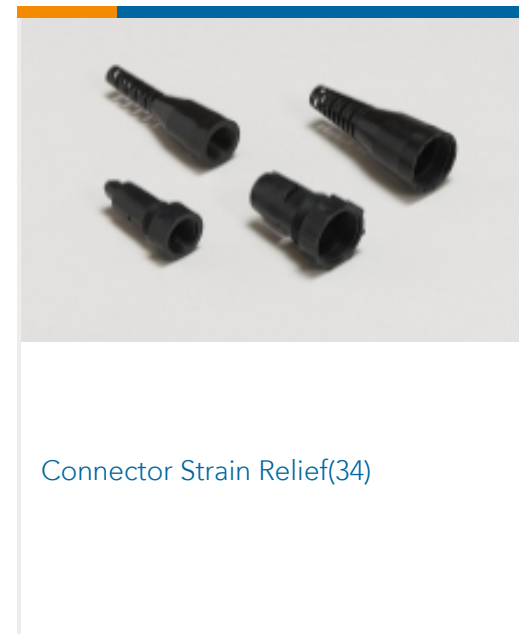
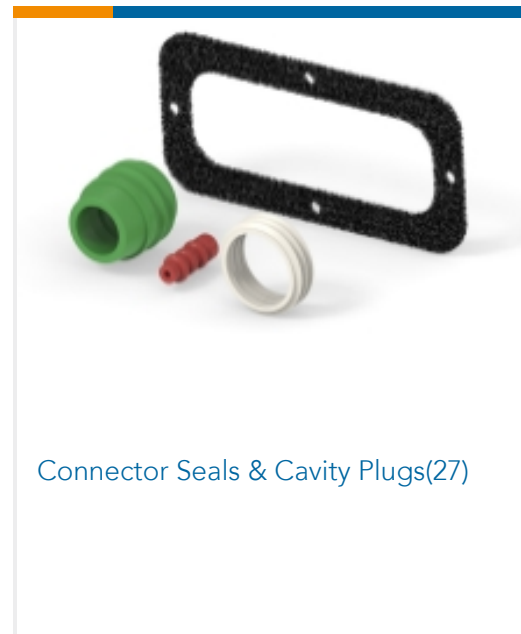
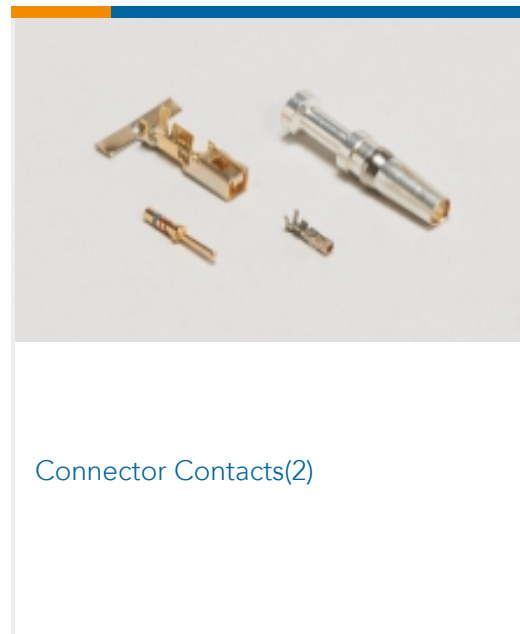
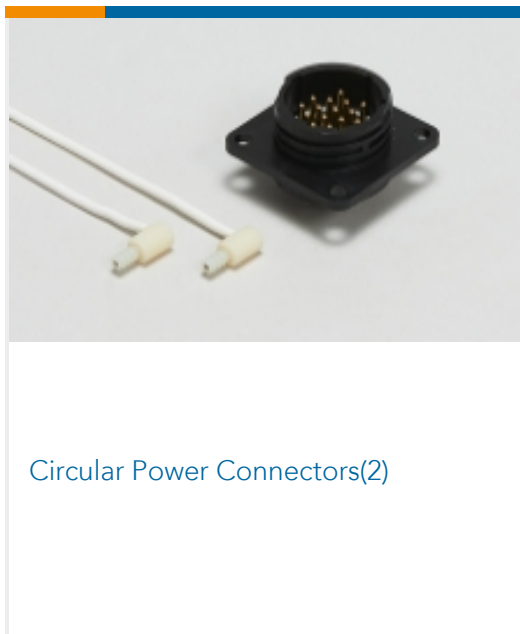

Customers Also Bought

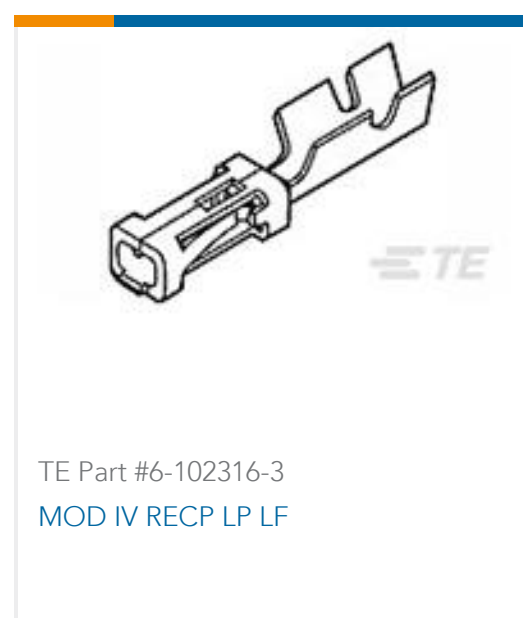
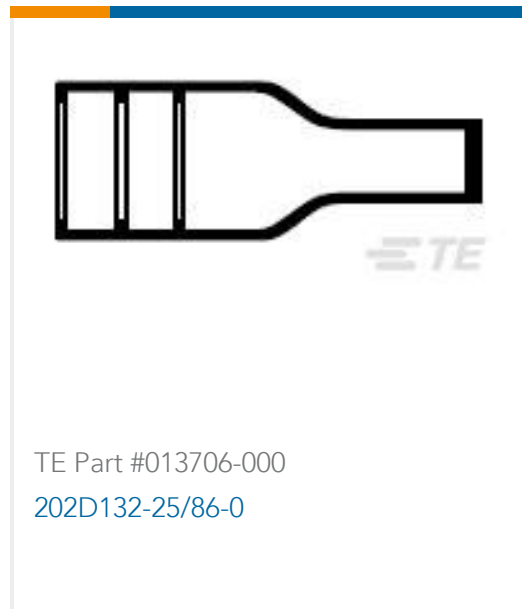
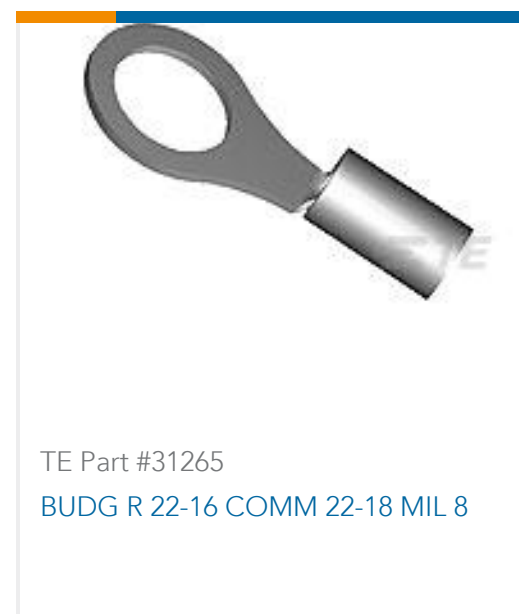

Documents

Product Drawings

UMNL II PIN AUSN/NI/BR

English

CAD Files

3D PDF

3D

Customer View Model

[ENG_CVM_CVM_1-770007-0_T.2d_dxf.zip](#)

English

Customer View Model

[ENG_CVM_CVM_1-770007-0_T.3d_igs.zip](#)

English

Customer View Model

[ENG_CVM_CVM_1-770007-0_T.3d_stp.zip](#)

English

By downloading the CAD file I accept and agree to the [Terms and Conditions](#) of use.

Datasheets & Catalog Pages



[SOFT_SHELL_PIN_SOCKET_CONNECTORS_STANDARD_DENSITY](#)

English

[Product Specifications](#)

[Application Specification](#)

English

[Product Environmental Compliance](#)

[MD_1-770007-0_062820112337](#)

English

[MD_1-770007-0_062820112337](#)

English