

1-640525-0 ✓ ACTIVE

AMP | AMP MR

TE Internal #: 1-640525-0

Rectangular Power Connectors, Housing, Plug, Wire-to-Wire / Wire-to-Board, 24 Position, 4.2 mm [.165 in] Centerline, Wire & Cable, UL 94V-0, AMP MR

[View on TE.com >](#)



Connectors > Power Connectors > Rectangular Power > Rectangular Power Connectors



Rectangular Power Connector Type: **Housing**

Connector & Housing Type: **Plug**

Connector System: **Wire-to-Board, Wire-to-Wire**

Number of Positions: **24**

Centerline (Pitch): **4.2 mm [.165 in]**

Features

Product Type Features

Rectangular Power Connector Type	Housing
Connector & Housing Type	Plug
Connector System	Wire-to-Board, Wire-to-Wire
Sealable	No
Connector & Contact Terminates To	Wire & Cable

Configuration Features

Number of Positions	24
Number of Power Positions	0
Number of Signal Positions	24
Number of Rows	6

Electrical Characteristics

Operating Voltage	250 VDC
-------------------	---------

Contact Features

Contact Current Rating (Max)	9 A
------------------------------	-----



Contact Retention Within Housing	With
----------------------------------	------

Contact Type	Socket
--------------	--------

Termination Features

Termination Method to Wire & Cable	Crimp
------------------------------------	-------

Mechanical Attachment

Mating Retention	With
------------------	------

Panel Mount Feature	Without
---------------------	---------

Mating Retention Type	Positive Lock
-----------------------	---------------

Connector Mounting Type	Panel Mount
-------------------------	-------------

Housing Features

Centerline (Pitch)	4.2 mm [.165 in]
--------------------	------------------

Housing Color	Black
---------------	-------

Housing Material	PA 66
------------------	-------

Dimensions

Connector Height	12.95 mm [.51 in]
------------------	-------------------

Product Width	33.91 mm [1.335 in]
---------------	---------------------

Product Length	21.34 mm [.84 in]
----------------	-------------------

Compatible Insulation Diameter Range	2.92 mm [.115 in]
--------------------------------------	-------------------

Wire Size	.12 – .8 mm ²
-----------	--------------------------

Row-to-Row Spacing	4.19 mm [.165 in]
--------------------	-------------------

Usage Conditions

Operating Temperature Range	-55 – 85 °C [-67 – 185 °F]
-----------------------------	----------------------------

Operation/Application

Circuit Application	Power & Signal
---------------------	----------------

Industry Standards

CSA Rating	LR 7189
------------	---------

UL Rating	Recognized
-----------	------------

Agency/Standard	CSA, UL
-----------------	---------

Approved Standards	UL E28476
--------------------	-----------

UL Flammability Rating	UL 94V-0
------------------------	----------

Glow Wire Rating	Standard Part - Not Glow Wire
------------------	-------------------------------

Packaging Features

Packaging Quantity	1
Packaging Method	Box

Product Compliance

[For compliance documentation, visit the product page on TE.com>](#)

EU RoHS Directive 2011/65/EU	Compliant
EU ELV Directive 2000/53/EC	Compliant
China RoHS 2 Directive MIIT Order No 32, 2016	No Restricted Materials Above Threshold
EU REACH Regulation (EC) No. 1907/2006	Current ECHA Candidate List: JUNE 2023 (235) Candidate List Declared Against: JUNE 2023 (235) Does not contain REACH SVHC
Halogen Content	Not Low Halogen - contains Br or Cl > 900 ppm.
Solder Process Capability	Wave solder capable to 240°C

Product Compliance Disclaimer

This information is provided based on reasonable inquiry of our suppliers and represents our current actual knowledge based on the information they provided. This information is subject to change. The part numbers that TE has identified as EU RoHS compliant have a maximum concentration of 0.1% by weight in homogenous materials for lead, hexavalent chromium, mercury, PBB, PBDE, DBP, BBP, DEHP, DIBP, and 0.01% for cadmium, or qualify for an exemption to these limits as defined in the Annexes of Directive 2011/65/EU (RoHS2). Finished electrical and electronic equipment products will be CE marked as required by Directive 2011/65/EU. Components may not be CE marked. Additionally, the part numbers that TE has identified as EU ELV compliant have a maximum concentration of 0.1% by weight in homogenous materials for lead, hexavalent chromium, and mercury, and 0.01% for cadmium, or qualify for an exemption to these limits as defined in the Annexes of Directive 2000/53/EC (ELV). Regarding the REACH Regulation, the information TE provides on SVHC in articles for this part number is based on the latest European Chemicals Agency (ECHA) 'Guidance on requirements for substances in articles' posted at this URL: <https://echa.europa.eu/guidance-documents/guidance-on-reach>

Compatible Parts





Also in the Series | AMP MR

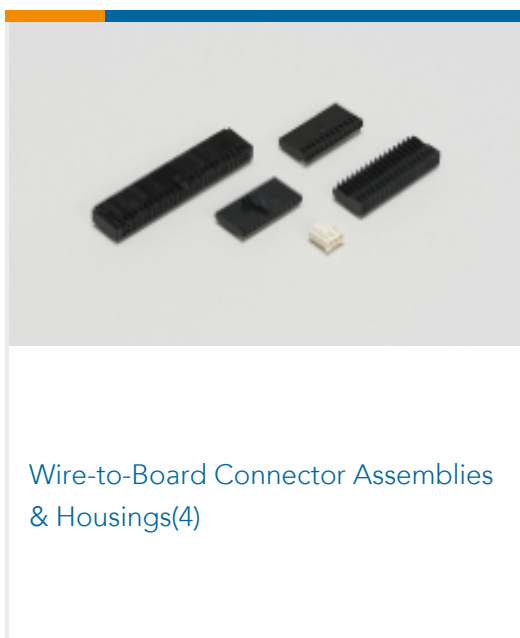
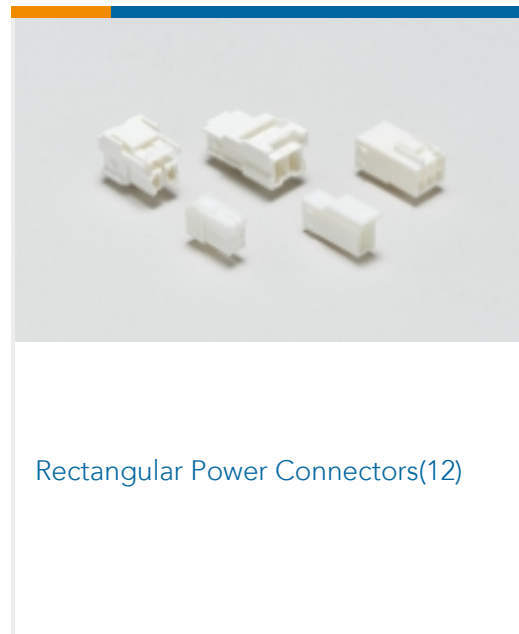
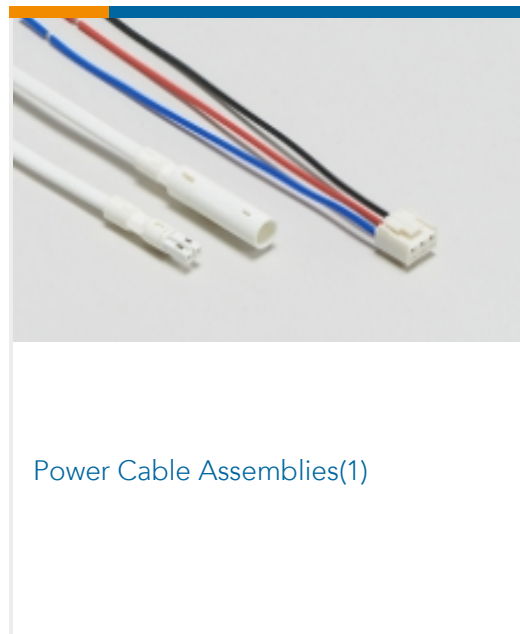
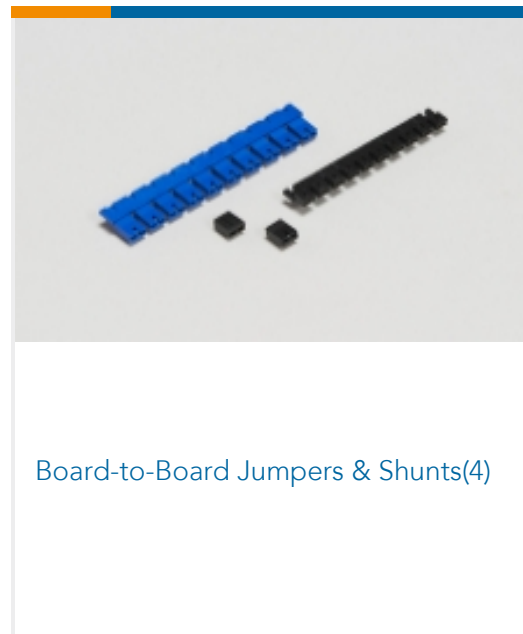
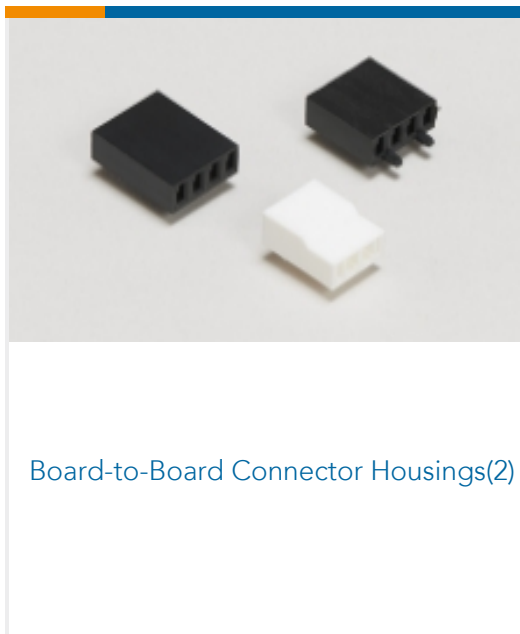

Customers Also Bought

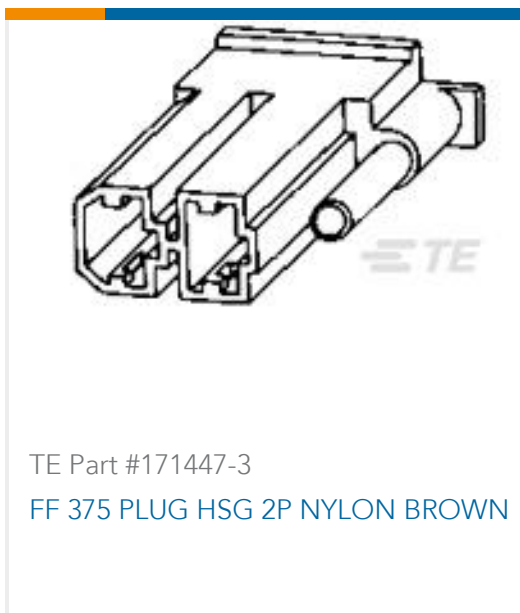

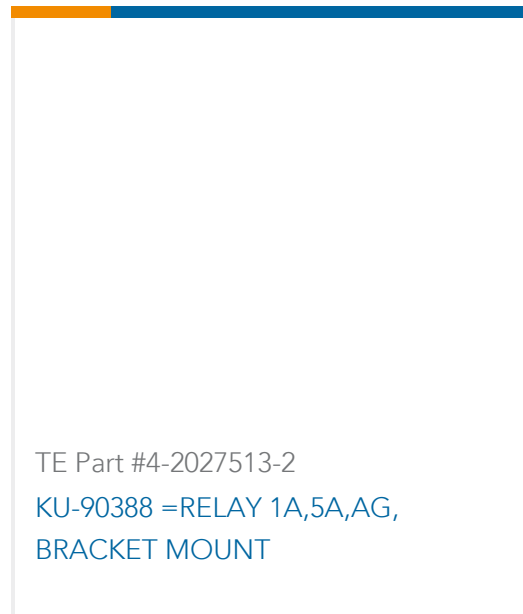
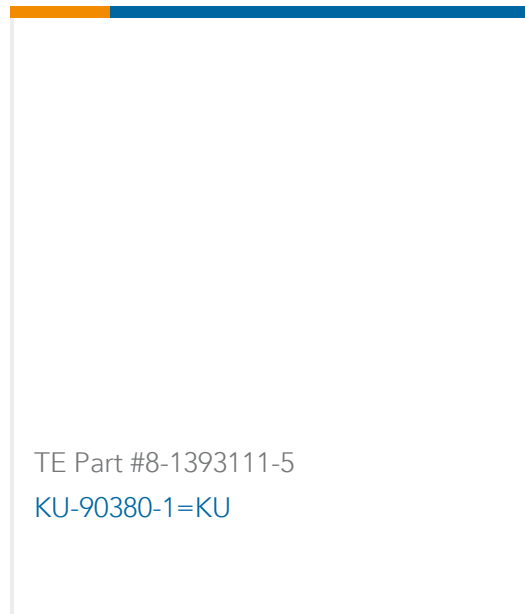
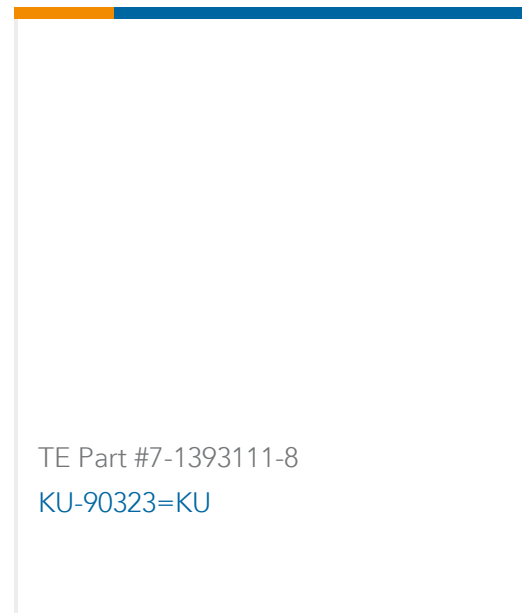
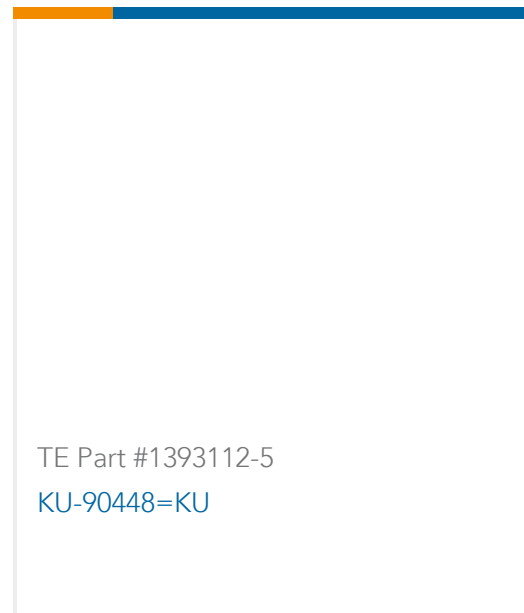
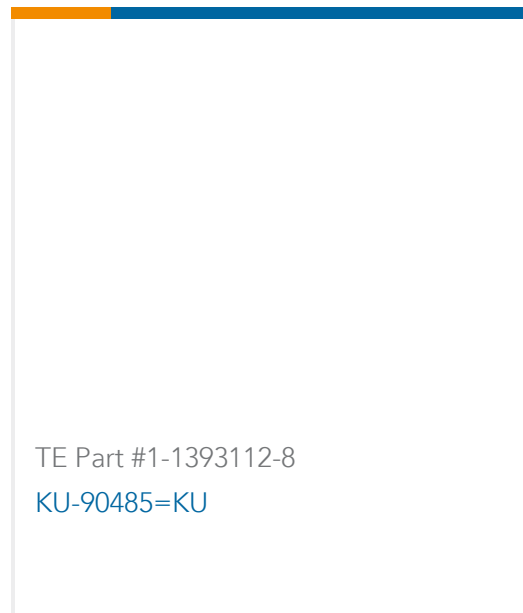

Documents

CAD Files

3D PDF

English

Customer View Model

[ENG_CVM_1-640525-0_E.2d_dxf.zip](#)

English

Customer View Model

[ENG_CVM_1-640525-0_E.3d_igs.zip](#)

English

Customer View Model

[ENG_CVM_1-640525-0_E.3d_stp.zip](#)

English

3D PDF

3D

Customer View Model

[ENG_CVM_CVM_1-640525-0_AE.2d_dxf.zip](#)

English

Customer View Model

[ENG_CVM_CVM_1-640525-0_AE.3d_igs.zip](#)

English

Customer View Model

[ENG_CVM_CVM_1-640525-0_AE.3d_stp.zip](#)

English

By downloading the CAD file I accept and agree to the [Terms and Conditions](#) of use.

Datasheets & Catalog Pages

[SOFT_SHELL_PIN_AND_SOCKET_CONNECTORS_CATALOG](#)



English

Product Specifications

[Application Specification](#)

English

Product Environmental Compliance

[Product Compliance Document](#)

English

[Product Compliance Document](#)

English

Instruction Sheets

[Instruction Sheet \(U.S.\)](#)

English

[AMP* MINIATURE RECTANGULAR II \(MRII\) CONNECTORS](#)

English

Agency Approvals

[Agency Approval Document](#)

English